

**FINAL**

**SOUTH BRANCH BLACKLICK CREEK  
WATERSHED TMDL  
Cambria and Indiana Counties**

For Acid Mine Drainage Affected Segments



Prepared by:

Pennsylvania Department of Environmental Protection

January 14, 2005

**TABLE OF CONTENTS**

Introduction..... 3  
Directions to the South Branch Blacklick Creek Watershed..... 4  
Segments addressed in this TMDL..... 5  
Clean Water Act Requirements ..... 5  
Section 303(d) Listing Process ..... 6  
Basic Steps for Determining a TMDL..... 7  
Watershed History ..... 7  
AMD Methodology..... 9  
Method to Quantify Treatment Pond Pollutant Load ..... 11  
TMDL Endpoints..... 12  
TMDL Elements (WLA, LA, MOS) ..... 13  
Allocation Summary ..... 13  
Recommendations..... 18  
Public Participation..... 20

**TABLES**

Table 1. 303(d) Sub-List..... 3  
Table 2. Applicable Water Quality Criteria..... 12  
Table 3. TMDL Component Summary for the South Branch Blacklick Creek Watershed ..... 14  
Table 4. Waste Load Allocations of Permitted Discharges ..... 17

**ATTACHMENTS**

**ATTACHMENT A**..... 21  
    South Branch Blacklick Creek Watershed Maps..... 21  
**ATTACHMENT B**..... 30  
    Method for Addressing Section 303(d) Listings for pH..... 30  
**ATTACHMENT C**..... 33  
    TMDLs By Segment..... 33  
**ATTACHMENT D**..... 54  
    Excerpts Justifying Changes Between the 1996, 1998, and 2002 Section 303(d) Lists..... 54  
**ATTACHMENT E**..... 56  
    Water Quality Data Used In TMDL Calculations ..... 56  
**ATTACHMENT F**..... 63  
    Comment and Response..... 63

**TMDL<sup>1</sup>**  
**South Branch Blacklick Creek Watershed**  
**Cambria and Indiana Counties, Pennsylvania**

**Introduction**

This report presents the Total Maximum Daily Loads (TMDLs) developed for segments in the South Branch Blacklick Creek Watershed (Attachments A). These were done to address the impairments noted on the 1996 Pennsylvania Section 303(d) list of impaired waters, required under the Clean Water Act, and covers one segment on this list and two additional segments from a subsequent list (shown in Table 1). High levels of metals, and in some areas depressed pH, caused these impairments. All impairments resulted from acid drainage from abandoned coalmines. The TMDL addresses the three primary metals associated with acid mine drainage (iron, manganese, aluminum) and pH.

<b>Table 1. 303(d) Sub-List</b>								
<b>State Water Plan (SWP) Subbasin: 18-D Two Lick Creek</b>								
<b>Year</b>	<b>Miles</b>	<b>Segment ID</b>	<b>DEP Stream Code</b>	<b>Stream Name</b>	<b>Designated Use</b>	<b>Data Source</b>	<b>Source</b>	<b>EPA 305(b) Cause Code</b>
1996	1.5, 3	5086	44618	South Branch Blacklick Creek	CWF	305(b) Report	RE	Metals
1998	1.54	5086	44618	South Branch Blacklick Creek	CWF	SWMP	AMD	Metals
2002	1.02	5086	44618	South Branch Blacklick Creek	CWF	SWMP	AMD	Metals
1996	Not included on 1996 303(d) List							
1998	Not included on 1998 303(d) List							
2002	1.65	990102-0855-TVP	44618	South Branch Blacklick Creek	CWF	SWMP	AMD	Metals & Ph
1996	Not included on 1996 303(d) List							
1998	Not included on 1998 303(d) List							
2002	5.12	990102-0900-TVP	44618	South Branch Blacklick Creek	CWF	SWMP	AMD	Metals & pH

Resource Extraction=RE  
Cold Water Fishes = CWF  
Surface Water Monitoring Program = SWMP  
Abandoned Mine Drainage = AMD

<sup>1</sup> Pennsylvania's 1996, 1998, and 2002 Section 303(d) lists were approved by the Environmental Protection Agency (EPA). The 1996 Section 303(d) list provides the basis for measuring progress under the 1997 lawsuit settlement of *American Littoral Society and Public Interest Group of Pennsylvania v. EPA*.

See Attachment D, *Excerpts Justifying Changes Between the 1996, 1998, and 2002 Section 303(d) Lists*.

The use designations for the stream segments in this TMDL can be found in PA Title 25 Chapter 93.

### **Directions to the South Branch Blacklick Creek Watershed**

The South Branch Blacklick Creek (South Branch) is an east-to-west flowing stream, located in southwestern Pennsylvania within Cambria County. The final two hundred yards of the stream flow into Indiana County, where it joins the North Branch Blacklick Creek. The two branches form Blacklick Creek, a major tributary of the Conemaugh River. The South Branch watershed area includes portions of the Vintondale, Nanty Glo, Colver, Carrolltown, and Ebensburg 7.5-minute United States Geological Survey quadrangle maps. The watershed area is approximately 47 square miles, and the South Branch flows for approximately 14.2 miles from its headwaters to its mouth.

The boroughs of Vintondale, and Nanty Glo, as well as the villages of Twin Rocks and Revloc are located along the South Branch. These communities were originally founded as mining towns. Outside the residential areas, much of the South Branch watershed is forested and includes several thousand acres of State Game Lands No. 79. There are some limited agricultural areas in the headwaters of the South Branch.

US Route 22, US Route 422, US Route 219 and SR 271 all pass through the South Branch Watershed and are the major access routes to it.

A portion of the Ghost Town Trail, a rails-to-trails biking and hiking path, parallels the South Branch for six miles from the stream mouth at Vintondale to Nanty Glo. The trail is named for several small mining villages that once thrived along Blacklick Creek, but that now are marked only by stone foundation remnants. The portion of the Ghost Town Trail that follows the South Branch is part of a larger, and expanding, trail network along the Blacklick Creek and its tributaries. An additional five-mile segment of the trail, from Nanty Glo to Revloc then on to Ebensburg was constructed during the summer of 2003. Approximately 75,000 visitors use the trail each year.

From east to west the named tributaries of the South Branch are Williams Run, Stewart Run, Pergrin Run, Coal Pit Run, Bracken Run, and Shuman Run. Williams Run is of good chemical quality and is not affected by mine drainage; the Williams Run Reservoir is a public water supply source for Revloc, Nanty Glo, Twin Rocks, Vintondale, and significant areas of Jackson Township. Stewart Run is unaffected by mine drainage and is designated a high quality, cold water fishery by Pennsylvania; the PA Fish and Boat Commission stock trout in Stewart Run each year. Pergrin Run is severely degraded by acid mine drainage, primarily from a large abandoned coal refuse pile and the abandoned Webster deep mine discharge. Coal Pit Run is degraded by mine drainage from several abandoned deep mine openings on the Lower Kittanning Coal seam. Bracken and Shuman Runs are slightly degraded by mine drainage from

abandoned surface and deep mines, but also suffer from depressed pH due to acid precipitation and the natural chemical composition of the rocks that occur in the headwaters of these streams; these two streams arise from strata in the Lower Allegheny and Pottsville rock groups, which contain no strata with appreciable calcium carbonate, but which do include thick sequences of high-silica sandstones.

The South Branch is located in the Allegheny Plateau physiographic province. The stream is incised deeply into the Plateau and the watershed has over 1000 feet of topographic relief. Elevations in the watershed range from about 1380 feet at the stream mouth in Vintondale to over 2400 feet in the headwater areas of Bracken and Shuman Runs. The rocks of the watershed are broadly folded in a series of northeast to southwest trending folds typical of the Plateau. Between Nanty Glo and Vintondale, the South Branch dissects the Laurel Ridge Anticline, forming a relatively high gradient and especially scenic portion of the watershed.

### **Segments addressed in this TMDL**

The South Branch Blacklick Creek Watershed is affected by pollution from AMD. This pollution has caused high levels of metals and low pH in the mainstem of the South Branch downstream of Revloc, where the stream flows through a large coal refuse pile. Williams Run and Stewart Run are not affected by mine drainage. Pergrin Run is severely degraded by AMD, while Coal Pit and Bracken Runs are impacted by AMD, but not nearly as badly as Pergrin Run.

The three permitted deep mine discharges and three active surface mine sites in the watershed are treated as point sources and are assigned waste load allocations. All of the remaining discharges in the watershed are treated as non-point sources. Each segment on the Section 303(d) list will be addressed as a separate TMDL. These TMDLs will be expressed as long-term, average loadings. Due to the nature and complexity of mining effects on the watershed, expressing the TMDL as a long-term average gives a better representation of the data used for the calculations. See Attachment C for TMDL calculations.

### **Clean Water Act Requirements**

Section 303(d) of the 1972 Clean Water Act requires states, territories, and authorized tribes to establish water quality standards. The water quality standards identify the uses for each waterbody and the scientific criteria needed to support that use. Uses can include designations for drinking water supply, contact recreation (swimming), and aquatic life support. Minimum goals set by the Clean Water Act require that all waters be “fishable” and “swimmable.”

Additionally, the federal Clean Water Act and the Environmental Protection Agency’s (EPA) implementing regulations (40 CFR Part 130) require:

- States to develop lists of impaired waters for which current pollution controls are not stringent enough to meet water quality standards (the list is used to determine which streams need TMDLs);

- States to establish priority rankings for waters on the lists based on severity of pollution and the designated use of the waterbody; states must also identify those waters for which TMDLs will be developed and a schedule for development;
- States to submit the list of waters to EPA every two years (April 1 of the even numbered years);
- States to develop TMDLs, specifying a pollutant budget that meets state water quality standards and allocate pollutant loads among pollution sources in a watershed, e.g., point and nonpoint sources; and
- EPA to approve or disapprove state lists and TMDLs within 30 days of final submission.

Despite these requirements, states, territories, authorized tribes, and EPA had not developed many TMDLs. Beginning in 1986, organizations in many states filed lawsuits against the EPA for failing to meet the TMDL requirements contained in the federal Clean Water Act and its implementing regulations. While EPA has entered into consent agreements with the plaintiffs in several states, other lawsuits still are pending across the country.

In the cases that have been settled to date, the consent agreements require EPA to backstop TMDL development, track TMDL development, review state monitoring programs, and fund studies on issues of concern (e.g., AMD, implementation of nonpoint source Best Management Practices (BMPs), etc.).

These TMDLs were developed in partial fulfillment of the 1997 lawsuit settlement of *American Littoral Society and Public Interest Group of Pennsylvania v. EPA*.

### **Section 303(d) Listing Process**

Prior to developing TMDLs for specific waterbodies, there must be sufficient data available to assess which streams are impaired and should be on the Section 303(d) list. With guidance from the EPA, the states have developed methods for assessing the waters within their respective jurisdictions.

The primary method adopted by the Pennsylvania Department of Environmental Protection (DEP) for evaluating waters changed between the publication of the 1996 and 1998 Section 303(d) lists. Prior to 1998, data used to list streams were in a variety of formats, collected under differing protocols. Information also was gathered through the Section 305(b)<sup>2</sup> reporting process. DEP is now using the Statewide Surface Waters Assessment Protocol (SSWAP), a modification of the EPA's 1989 Rapid Bioassessment Protocol II (RBP-II), as the primary mechanism to assess Pennsylvania's waters. The SSWAP provides a more consistent approach to assessing Pennsylvania's streams.

---

<sup>2</sup> Section 305(b) of the Clean Water Act requires a biannual description of the water quality of the waters of the state.

The assessment method requires selecting representative stream segments based on factors such as surrounding land uses, stream characteristics, surface geology, and point source discharge locations. The biologist selects as many sites as necessary to establish an accurate assessment for a stream segment; the length of the assessed stream segment can vary between sites. All the biological surveys included kick-screen sampling of benthic macroinvertebrates and habitat evaluations. Benthic macroinvertebrates are identified to the family level in the field.

After the survey is completed, the biologist determines the status of the stream segment. The decision is based on habitat scores and a series of narrative biological statements used to evaluate the benthic macroinvertebrate community. If the stream is determined to be impaired, the source and cause of the impairment is documented. An impaired stream must be listed on the state's Section 303(d) list with the source and cause. A TMDL must be developed for the stream segment and each pollutant. In order for the process to be more effective, adjoining stream segments with the same source and cause listing are addressed collectively, and on a watershed basis.

### **Basic Steps for Determining a TMDL**

Although all watersheds must be handled on a case-by-case basis when developing TMDLs, there are basic processes or steps that apply to all cases. They include:

1. Collection and summarization of pre-existing data (watershed characterization, inventory contaminant sources, determination of pollutant loads, etc.);
2. Calculating TMDL for the waterbody using EPA approved methods and computer models;
3. Allocating pollutant loads to various sources;
4. Determining critical and seasonal conditions;
5. Public review and comment period on draft TMDL;
6. Submittal of final TMDL; and
7. EPA approval of the TMDL.

### **Watershed History**

Mining began in the South Branch Watershed in the early 1800's and continues to this day. Most of the coal that was removed from the watershed has been extracted from deep mines on the Lower Kittanning and Lower Freeport coal seams. In fact, deep mines on one or more levels underlay the majority of the watershed area. The AMD-impacted segments of the stream occur downstream of where the Lower Kittanning coal seam crops to the surface, and majority of the problems on the watershed are related in one way or another to Lower Kittanning mining. Surface mining on the watershed has occurred primarily in the Twin Rocks area and in the upland areas on either side of the South Branch segment between Twin Rocks and Vintondale. The seams most commonly surface mined have been the Lower Kittanning and Lower Freeport

seams, with lesser amounts of surface mining on the Middle Kittanning, Upper Freeport and Brookville seams.

There presently are three active surface mining sites in the watershed, all refuse reprocessing operations. All three active sites are permitted by Ebensburg Power Company. Two of the operations are reprocessing coal refuse that was deposited on opposite banks of the South Branch from a Lower Kittanning deep mine at the village of Revloc. These two sites are surface mining permits 11880201 and 11960202 and are located on opposite sides of the South Branch adjacent to Revloc. Both of these sites are screening coal refuse and shipping it to the Ebensburg Power Company circulating fluidized bed combustion plant in Ebensburg. Limestone is injected into the combustion chamber of the plant to reduce sulfur flue emissions. This process results in an ash that contains significant amounts of CaO. When water is added to the ash for handling purposes, some of the CaO converts to Ca(OH)<sub>2</sub>. Continual monitoring of the ash over the years shows that it leaches water with a high pH, excess alkalinity, and with acceptable metals concentrations, which makes it a good material for reclamation of acidic mine sites. Alkaline ash is returned to both of the Ebensburg Power Company permits for use in site reclamation. The ash is mixed with the oversized reject material and then is compacted to reduce infiltration. The resultant surface is covered with soil and vegetated.

Both Ebensburg Power Company Revloc sites have polluting discharges on them that pre-date Ebensburg Power's operations. The permits, therefore, are issued under DEP's subchapter F regulations, which provide that the permittee's effluent limits are based on baseline pollution conditions rather than standard coal mining BAT standards. Therefore, the subchapter F discharges on these sites have been treated as nonpoint source for the purpose of doing the TMDL, however, waste load allocations have been assigned to the permitted NPDES discharge points for these two active mine sites. It is anticipated that once the remining of these refuse piles is completed, the existing subchapter F pollutional discharges will be substantially, if not completely, remediated by the remining.

The third Ebensburg Power Company, located in Nanty Glo, has only recently been issued and will be activated in 2004. This operation (SMP# 11020202) will be conducted as described above for the Revloc sites. Subchapter F discharges on the Nanty Glo site have been handled as nonpoint discharges for the purposes of calculating the TMDL, and the projected permitted NPDES discharge has been assigned a waste load allocation. SMP# 11020202 will discharge to Pergin Run.

Ebensburg Power Company is currently gathering information for a fourth permit in the South Branch Watershed. That permit will also be located in Nanty Glo Borough, and is located on the opposite site of SR 271, from SMP# 11020202. This fourth site will also be a coal refuse reprocessing operation, and like the others, will abate poor quality discharges from an abandoned coal refuse pile. Once permitted and activated, this fourth site will be operated concurrently with SMP# 11020202. A waste load allocation will be included to account for the future mine. The company has reported to DEP that the two sites need to be operated concurrently in order to meet the fuel specifications for the waste-coal burning power plant that is burning the coal refuse to generate electricity. Operations at the two Nanty Glo sites are projected to last fifteen years.



The waste-coal power plant burning the fuel is also owned by Ebensburg Power Company. A majority of the fuel for the plant currently comes from the two Revloc sites. As the Revloc sites are exhausted, the Nanty Glo sites will be activated to replace them as the primary fuel source for the plant. Therefore, the Revloc sites will be completed and reclaimed as operations shift to the Nanty Glo pile. The Nanty Glo operations will be quite similar to those at the Revloc site, so the waste load allocations will be calculated the same as those from the Revloc site. Handling the waste load allocations of the Ebensburg Power Company sites in this manner will most-closely match the reality of how the sites will be operated. Incidentally, discharges from the NPDES points on these sites will be occasional events of a small magnitude, a point shown by discharge monitoring reports for the Revloc site. The reasons include: 1) the operations are removing material only from the surface and do not include excavation into the water table, therefore no groundwater is encountered; 2) the abandoned coal refuse is quite porous, thus significant storm water runoff typically occurs only during unusually heavy runoff events.

There is also one active producing deep mine on the South Branch and two permitted NPDES discharge points from completed deep mines that have a permanent treatment liability. The active deep mine is operated by Rosebud Mining Company, CMAP# 11991301, located on State Game Lands No. 79 and discharges to unnamed tributary 44625. The Rosebud Mining site is extracting Lower Freeport coal, and produces raw water that is alkaline and low in metals. The two completed deep mines that discharge to the South Branch were operated by Beth Energy Mines, Inc. for several decades before closing. International Steel Group (ISG) recently purchased Bethlehem Steel Corporation, including Beth Energy Mines. The mine represented by permit CMAP# 11841301 discharges to the South Branch upstream of unnamed tributary 44646. The mine represented by permit CMAP# 11701301 discharges to unnamed tributary 44637. Each of these discharges have been assigned a waste load allocation calculated with the permit limits and measured flows.

## **AMD Methodology**

A two-step approach is used for the TMDL analysis of AMD impaired stream segments. The first step uses a statistical method for determining the allowable instream concentration at the point of interest necessary to meet water quality standards. This is done at each point of interest (sample point) in the watershed. The second step is a mass balance of the loads as they pass through the watershed. Loads at these points will be computed based on average annual flow.

The statistical analysis described below can be applied to situations where all of the pollutant loading is from non-point sources as well as those where there are both point and non-point sources. The following defines what are considered point sources and non-point sources for the purposes of our evaluation; point sources are defined as permitted discharges or a discharge that has a responsible party, non-point sources are then any pollution sources that are not point sources. For situations where all of the impact is due to non-point sources, the equations shown below are applied using data for a point in the stream. The load allocation made at that point will be for all of the watershed area that is above that point. For situations where there are point-source impacts alone, or in combination with non-point sources, the evaluation will use the point-source data and perform a mass balance with the receiving water to determine the impact of the point source.

Allowable loads are determined for each point of interest using Monte Carlo simulation. Monte Carlo simulation is an analytical method meant to imitate real-life systems, especially when other analyses are too mathematically complex or too difficult to reproduce. Monte Carlo simulation calculates multiple scenarios of a model by repeatedly sampling values from the probability distribution of the uncertain variables and using those values to populate a larger data set. Allocations were applied uniformly for the watershed area specified for each allocation point. For each source and pollutant, it was assumed that the observed data were log-normally distributed. Each pollutant source was evaluated separately using @Risk<sup>3</sup> by performing 5,000 iterations to determine the required percent reduction so that the water quality criteria, as defined in the *Pennsylvania Code. Title 25 Environmental Protection, Department of Environmental Protection, Chapter 93, Water Quality Standards*, will be met instream at least 99 percent of the time. For each iteration, the required percent reduction is:

$$PR = \text{maximum } \{0, (1 - Cc/Cd)\} \text{ where} \quad (1)$$

PR = required percent reduction for the current iteration

Cc = criterion in mg/l

Cd = randomly generated pollutant source concentration in mg/l based on the observed data

$$Cd = \text{RiskLognorm}(\text{Mean}, \text{Standard Deviation}) \text{ where} \quad (1a)$$

Mean = average observed concentration

Standard Deviation = standard deviation of observed data

The overall percent reduction required is the 99th percentile value of the probability distribution generated by the 5,000 iterations, so that the allowable long-term average (LTA) concentration is:

$$LTA = \text{Mean} * (1 - PR_{99}) \text{ where} \quad (2)$$

LTA = allowable LTA source concentration in mg/l

Once the allowable concentration and load for each pollutant is determined, mass-balance accounting is performed starting at the top of the watershed and working down in sequence. This mass-balance or load tracking is explained below.

---

<sup>3</sup>@Risk – Risk Analysis and Simulation Add-in for Microsoft Excel, Palisade Corporation, Newfield, NY, 1990-1997.

Load tracking through the watershed utilizes the change in measured loads from sample location to sample location, as well as the allowable load that was determined at each point using the @Risk program.

There are two basic rules that are applied in load tracking; rule one is that if the sum of the measured loads that directly affect the downstream sample point is less than the measured load at the downstream sample point it is indicative that there is an increase in load between the points being evaluated, and this amount (the difference between the sum of the upstream and downstream loads) shall be added to the allowable load(s) coming from the upstream points to give a total load that is coming into the downstream point from all sources. The second rule is that if the sum of the measured loads from the upstream points is greater than the measured load at the downstream point this is indicative that there is a loss of instream load between the evaluation points, and the ratio of the decrease shall be applied to the load that is being tracked (allowable load(s)) from the upstream point.

Tracking loads through the watershed gives the best picture of how the pollutants are affecting the watershed based on the information that is available. The analysis is done to insure that water quality standards will be met at all points in the stream. The TMDL must be designed to meet standards at all points in the stream, and in completing the analysis, reductions that must be made to upstream points are considered to be accomplished when evaluating points that are lower in the watershed. Another key point is that the loads are being computed based on average annual flow and should not be taken out of the context for which they are intended, which is to depict how the pollutants affect the watershed and where the sources and sinks are located spatially in the watershed.

For pH TMDLs, acidity is compared to alkalinity as described in Attachment B. Each sample point used in the analysis of pH by this method must have measurements for total alkalinity and total acidity. Net alkalinity is alkalinity minus acidity, both in units of milligrams per liter (mg/l)  $\text{CaCO}_3$ . Statistical procedures are applied, using the average value for total alkalinity at that point as the target to specify a reduction in the acid concentration. By maintaining a net alkaline stream, the pH value will be in the range between six and eight. This method negates the need to specifically compute the pH value, which for streams affected by low pH from AMD may not a true reflection of acidity. This method assures that Pennsylvania's standard for pH is met when the acid concentration reduction is met.

Information for the TMDL analysis performed using the methodology described above is contained in the "TMDLs by Segment" section of this report.

### **Method to Quantify Treatment Pond Pollutant Load**

Surface coal mines remove soil and overburden materials to expose the underground coal seams for removal. After removal of the coal, the overburden is replaced as mine spoil and the soil is replaced for revegetation. In a typical surface mining operation the overburden materials is removed and placed in the previous cut where the coal has been removed. In this fashion, an active mining operation has a pit that progresses through the mining site during the life of the

mine. The pit may have water reporting to it, as it is a low spot in the local area. Pit water can be the result of limited shallow groundwater seepage, direct precipitation into the pit, and surface runoff from partially regraded areas that have been backfilled but not yet revegetated. Pit water is pumped to nearby treatment ponds where it is treated to the required treatment pond effluent limits. The standard effluent limits are as follows, although stricter effluent limits may be applied to a mining permit's effluent limits to insure that the discharge of treated water does not cause instream limits to be exceeded.

**Standard Treatment Pond Effluent Limits:**

- Alkalinity > Acidity
- 6.0 <= pH <= 9.0
- Fe <= 3.0 mg/l
- Mn <= 2.0 mg/l
- Al <= 2.0 mg/l

When a treatment plant has an NPDES permit a Waste Load Allocation (WLA) must be calculated. When there is flow data available this is used along with the permit Best Available Technology (BAT) limits for one or more of the following: aluminum, iron, and manganese. The following formula is used:

$$\text{Flow (mgd)} \times \text{BAT limit (mg/l)} \times 8.34 = \text{lbs/day}$$

**TMDL Endpoints**

One of the major components of a TMDL is the establishment of an instream numeric endpoint, which is used to evaluate the attainment of applicable water quality. An instream numeric endpoint, therefore, represents the water quality goal that is to be achieved by implementing the load reductions specified in the TMDL. The endpoint allows for a comparison between observed instream conditions and conditions that are expected to restore designated uses. The endpoint is based on either the narrative or numeric criteria available in water quality standards.

Because most of the pollution sources in the watershed are nonpoint sources, the largest part of the TMDL is expressed as Load Allocations (LAs). All allocations will be specified as long-term average daily concentrations. These long-term average concentrations are expected to meet water-quality criteria 99% of the time as required in PA Title 25 Chapter 96.3(c). The following table shows the applicable water-quality criteria for the selected parameters.

**Table 2. Applicable Water Quality Criteria**

<i>Parameter</i>	<i>Criterion Value (mg/l)</i>	<i>Total Recoverable/Dissolved</i>
Aluminum (Al)	0.75	Total Recoverable
Iron (Fe)	1.50	30 day average; Total Recoverable
Manganese (Mn)	1.00	Total Recoverable
pH *	6.0-9.0	N/A

\*The pH values shown will be used when applicable. In the case of freestone streams with little or no buffering capacity, the TMDL endpoint for pH will be the natural background water quality.

## **TMDL Elements (WLA, LA, MOS)**

$$\text{TMDL} = \text{WLA} + \text{LA} + \text{MOS}$$

A TMDL equation consists of a waste load allocation (WLA), load allocation (LA), and a margin of safety (MOS). The waste load allocation is the portion of the load assigned to point sources. The load allocation is the portion of the load assigned to non-point sources. The margin of safety is applied to account for uncertainties in the computational process. The margin of safety may be expressed implicitly (documenting conservative processes in the computations) or explicitly (setting aside a portion of the allowable load). The TMDL allocations in this report are based on available data. Other allocation schemes could also meet the TMDL.

### **Allocation Summary**

These TMDLs will focus remediation efforts on the identified numerical reduction targets for each watershed. The reduction schemes in Table 3 for each segment are based on the assumption that all upstream allocations are achieved and take into account all upstream reductions. Attachment C contains the TMDLs by segment analysis for each allocation point in a detailed discussion. As changes occur in the watershed, the TMDLs may be re-evaluated to reflect current conditions. An implicit MOS based on conservative assumptions in the analysis is included in the TMDL calculations.

The allowable LTA concentration in each segment is calculated using Monte Carlo Simulation as described previously. The allowable load is then determined by multiplying the allowable concentration by the flow and a conversion factor at each sample point. The allowable load is the TMDL.

Each permitted discharge in a segment is assigned a waste load allocation and the total waste load allocation for each segment is included in this table. There are currently ten permitted discharges in the watershed plus one anticipated discharge. The difference between the TMDL and the WLA at each point is the load allocation (LA) at the point. The LA at each point includes all loads entering the segment, including those from upstream allocation points. The percent reduction is calculated to show the amount of load that needs to be reduced within a segment in order for water quality standards to be met at the point.

In some instances, instream processes, such as settling, are taking place within a stream segment. These processes are evidenced by a decrease in measured loading between consecutive sample points. It is appropriate to account for these losses when tracking upstream loading through a segment. The calculated upstream load lost within a segment is proportional to the difference in the measured loading between the sampling points.

**Table 3. TMDL Component Summary for the South Branch Blacklick Creek Watershed**

Station	Parameter	Existing Load (lbs/day)	TMDL Allowable Load (lbs/day)	WLA* (lbs/day)	LA (lbs/day)	Load Reduction (lbs/day)	Percent Reduction %
	<i>South Branch, upstream of Unnamed Tributary 44661</i>						
	Fe	25,940	10,117	0	10,117	15,824	61
	Mn	7,415	5,783	0	5,783	1,631	22
	Al	5,327	5,327	NA	NA	0	0
	Acidity	401,815	216,980	0	216,980	184,835	46
	<i>Unnamed Tributary 44661</i>						
	Fe	206	206	NA	NA	0	0
	Mn	359	359	NA	NA	0	0
	Al	843	413	0	413	430	51
	Acidity	9,863	4,635	0	4,635	5,227	53
	<i>South Branch, downstream of Revloc</i>						
	Fe	45,396	24,514	1	24,513	5,059	17
	Mn	35,601	8,900	1	8,899	25,070	74
	Al	296,940	5,939	1	5,938	290,571	98
	Acidity	1,617,361	48,521	0	48,521	1,378,778	97
	<i>Mouth of Williams Run</i>						
	Fe	14,549	14,549	NA	NA	0	0
	Mn	2,342	2,342	NA	NA	0	0
	Al	4,119	4,119	NA	NA	0	0
	Acidity	245,662	88,438	0.0	88,438	157,224	64
	<i>South Branch, downstream of Unnamed Tributary 44667</i>						
	Fe	30,685	30,685	NA	NA	0	0
	Mn	38,042	24,347	0	24,347	0	0
	Al	93,831	34,718	0	34,718	0	0
	Acidity	617,243	228,380	0	228,380	0	0
	<i>South Branch, downstream of Unnamed Tributary 44646</i>						
	Fe	32,216	32,216	15	32,201	0	0
	Mn	35,974	23,023	10	23,014	0	0
	Al	77,194	19,299	10	19,289	0	0
	Acidity	793,835	214,335	0	214,335	7,633	3
	<i>Mouth of Stewart Run</i>						
	Fe	8,154	8,154	NA	NA	0	0
	Mn	1,087	1,087	NA	NA	0	0
	Al	2,130	2,130	NA	NA	0	0
	Acidity	452,643	452,643	NA	NA	0	0
	<i>South Branch, downstream of Stewart Run</i>						
	Fe	53,854	53,854	NA	NA	0	0
	Mn	24,215	24,215	NA	NA	0	0
	Al	28,542	21,978	0	21,978	0	0
	Acidity	1,713,583	908,199	0	908,199	225,884	20

Station	Parameter	Existing Load (lbs/day)	TMDL Allowable Load (lbs/day)	WLA* (lbs/day)	LA (lbs/day)	Load Reduction (lbs/day)	Percent Reduction %
	<i>South Branch, downstream of Unnamed Tributary 44637</i>						
	Fe	105,768	105,768	80	105,688	0	0
	Mn	47,690	47,690	46	47,644	0	0
	Al	97,498	34,124	46	34,079	36,526	52
	Acidity	1,585,047	649,869	0	649,869	190,206	23
	<i>Mouth of Pergrin Run</i>						
	Fe	864,642	6,052	1	6,051	858,590	99.3
	Mn	44,416	4,442	1	4,441	39,974	90
	Al	772,077	3,088	1	3,087	768,989	99.6
	Acidity	7,499,231	0	0	0	7,499,231	100
	<i>South Branch, downstream of Unnamed Tributary 44632</i>						
	Fe	1,153,388	57,669	0	57,669	226,440	80
	Mn	130,017	58,508	0	58,508	15,037	20
	Al	1,113,074	22,261	0	22,261	258,450	92
	Acidity	9,080,844	272,425	0	272,425	377,198	58
	<i>South Branch, upstream of Coalpit Run</i>						
	Fe	714,633	150,073	0	150,073	0	0
	Mn	161,173	80,586	0	80,586	9,077	10
	Al	1,198,102	35,943	0	35,943	71,347	66
	Acidity	8,977,001	179,540	0	179,540	89,770	33
	<i>Mouth of Coalpit Run</i>						
	Fe	13,927	10,027	0	10,027	3,900	28
	Mn	17,653	7,591	0	7,591	10,062	57
	Al	73,648	7,365	0	7,365	66,283	90
	Acidity	745,668	0	0	0	745,668	100
	<i>Mouth of Bracken Run</i>						
	Fe	886	886	NA	NA	0	0
	Mn	9,654	2,607	0	2,607	7,047	73
	Al	11,846	2,843	0	2,843	9,003	76
	Acidity	151,462	0	0	0	151,462	100
	<i>Mouth of South Branch Blacklick Creek</i>						
	Fe	919,834	266,752	3	266,749	0	0
	Mn	241,207	108,543	2	108,541	34,968	24
	Al	1,437,779	71,889	2	71,887	128,445	64
	Acidity	13,586,568	0	0	0	3,891,978	100

NA, meets WQS. No TMDL necessary.

\* Total Segment WLAs are rounded up to the nearest whole pound.

In the instance that the allowable load is equal to the existing load (e.g. aluminum BLCK09, Table 3), the simulation determined that water quality standards are being met instream 99% of the time and no TMDL is necessary for the parameter at that point. Although no TMDL is

necessary, the loading at the point is considered at the next downstream point. Although TMDLs for iron and manganese at BLCK04 and iron at BLCK06 are not necessary because WQS are met, WLAs are assigned to the permitted discharges within these segments.

Following is an example of how the allocations, presented in Table 3 are calculated. For this example, aluminum allocations for points BLCK04, BLCK05, BLCK06, and STEW01 are shown. As demonstrated in the example, all upstream contributing loads are accounted for at each point. Attachment C contains the TMDLs by segment analysis for each allocation point in a detailed discussion. These analyses follow the example. Attachment A contains a map of the sampling point locations for reference.

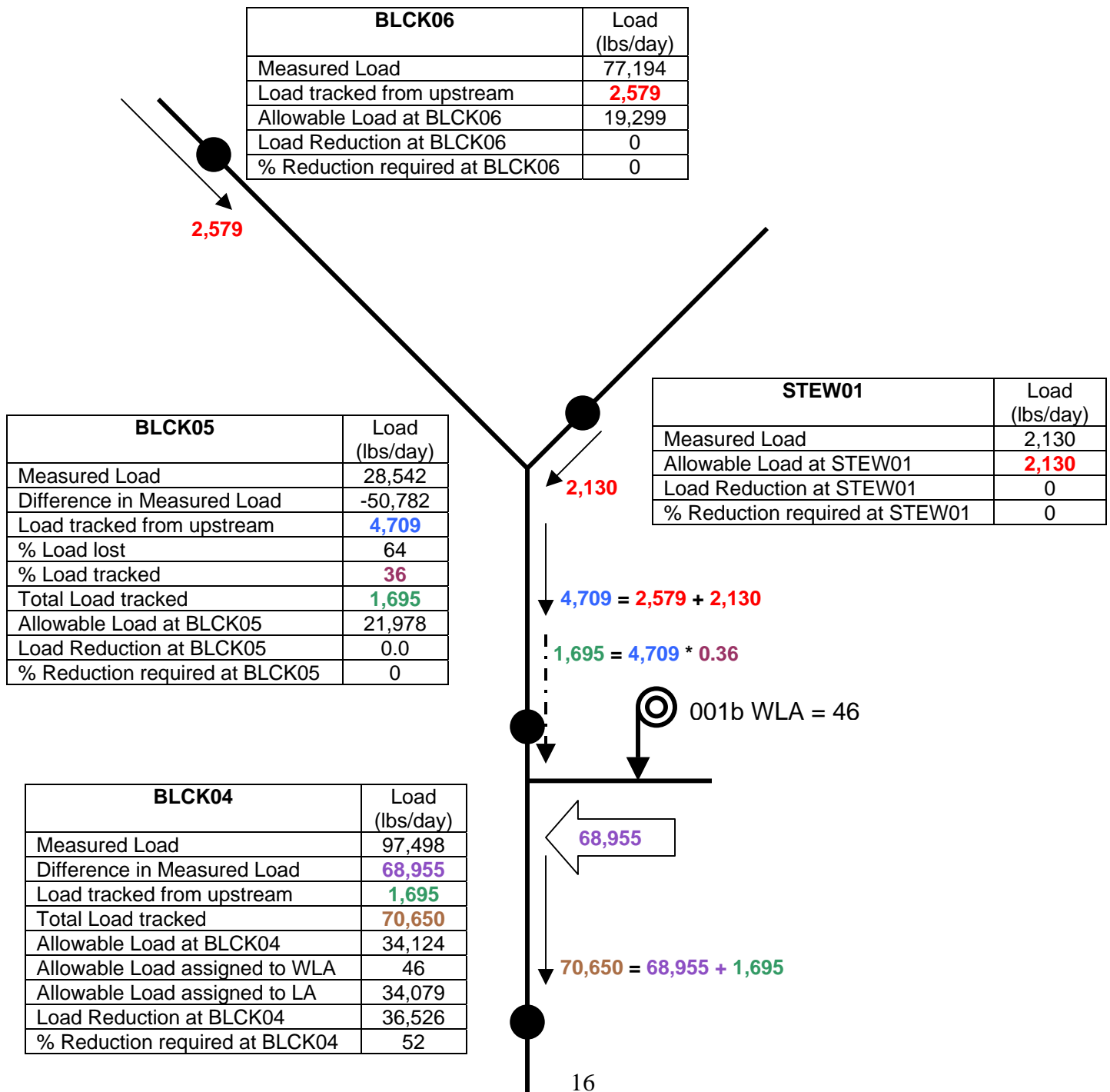



Waste load allocations are assigned to the ten permitted discharges and one future discharge in the South Branch Blacklick Creek Watershed. The waste load allocations are based on estimated and measured flows and the permit limits, which are Best Available Technology (BAT) limits. No reductions of permit limits are required at this time. All necessary reductions are assigned to the non-point sources. Flow measurements were available at 30, but not 001-004, NWP1, NWP2, and the future site; however, because the operations are all similar, the flows from 30 are used in calculating the WLAs for these points. Measured flow was used in calculating the WLAs for all remaining permitted discharges. Table 4 contains the waste load allocations for the permitted discharges.

**Table 4. Waste Load Allocations of Permitted Discharges**

<b>Discharge</b>	<b>Parameter</b>	<b>Allowable Average Monthly Conc. (mg/L)</b>	<b>Average Flow (MGD)</b>	<b>WLA (lbs/day)</b>
<b>Ebensburg Power Co., SMP 11880201, Revloc Refuse Site, NPDES PA0598208</b>				
001	Fe	3.0	0.001	0.02
	Mn	2.0	0.001	0.01
	Al	1.3	0.001	0.01
002	Fe	3.0	0.001	0.02
	Mn	2.0	0.001	0.01
	Al	1.3	0.001	0.01
003	Fe	3.0	0.001	0.02
	Mn	2.0	0.001	0.01
	Al	1.3	0.001	0.01
004	Fe	3.0	0.001	0.02
	Mn	2.0	0.001	0.01
	Al	1.3	0.001	0.01
<b>Ebensburg Power Co., SMP 11960202, Revloc #2 Refuse Site, NPDES PA0234311</b>				
30	Fe	3.0	0.001	0.02
	Mn	2.0	0.001	0.01
	Al	2.0	0.001	0.01
<b>Ebensburg Power Co., SMP 11020202</b>				
NWP1	Fe	3.0	0.001	0.02
	Mn	2.0	0.001	0.01
	Al	2.0	0.001	0.01
NWP2	Fe	3.0	0.001	0.02
	Mn	2.0	0.001	0.01
	Al	2.0	0.001	0.01
<b>Rosebud Mining Company, CMAP 11991301, NPDES PA0215210</b>				
TP-A	Fe	3.0	0.105	2.6
	Mn	2.0	0.105	1.8
	Al	2.0	0.105	1.8

Discharge	Parameter	Allowable Average Monthly Conc. (mg/L)	Average Flow (MGD)	WLA (lbs/day)
<b>Beth Energy Mines, Inc., CMAP 11841301, Cambria Slope Mine 33, PA0001317</b>				
001a	Fe	3.0	0.578	14.5
	Mn	2.0	0.578	9.6
	Al	2.0	0.578	9.6
<b>Beth Energy Mines, Inc. CMAP 11701301, Nanty-Glo Mine 31, NPDES PA0001333</b>				
001b	Fe	3.5	2.739	80.0
	Mn	2.0	2.739	45.7
	Al	2.0	2.739	45.7
<b>Future Mine Site</b>				
Future Site	Fe	3.0	0.001	0.02
	Mn	2.0	0.001	0.01
	Al	2.0	0.001	0.01

## Recommendations

The remining operations by Ebensburg Power Company will significantly improve segments of the South Branch Blacklick Creek. The on-going remining operations at Revloc will substantially address the first major AMD impairments to the South Branch and the about-to-begin operation at Nanty Glo will eliminate a significant amount of pollution to Pergrin Run. There is currently an active watershed group at work on the Blacklick Creek Watershed. The group is called the Blacklick Creek Watershed Association. The watershed group, in conjunction with the US Army Corp of Engineers, the Cambria County Conservation District, PA DEP, and other partners is currently constructing a vertical flow pond passive treatment system on the Webster deep mine discharge on Pergrin Run. The combination of remining and the Webster project will remove much of the AMD from Pergrin Run.

The Watershed Group has received funding, through the PA DEP Growing Greener program, to construct a remediation project in the headwaters of Coal Pit Run. Completion of this project is expected within the next two years.

A group called AMD & Art, Inc. has applied an innovative approach to helping address the AMD problems on the South Branch. This group has constructed a passive AMD treatment facility to address one of the mine discharges just east of Vintondale. By incorporating a public park and educational aspects into the project, AMD & Art was able to obtain funding for the project from sources that typically are not associated with mine drainage treatment or environmental remediation.

The Cambria District Mining Office of DEP has designated the South Branch Blacklick Creek as one of its priority watershed and plans to focus opportunities for remediation on this stream. To this end, the DEP South Branch team has been conducting an intensive assessment of Coal Pit Run. Once completed, by the end of 2003, data from the assessment will be used to propose

additional projects on Coal Pit Run. The DEP South Branch team then plans to turn its attention to other impacted segments, such as Bracken Run.

So the remediation of the South Branch has already begun, and opportunities for future remediation efforts are in the process of being identified.

Two primary programs provide maintenance and improvement of water quality in the watershed. DEP's efforts to reclaim abandoned mine lands, coupled with its duties and responsibilities for issuing NPDES permits, will be the focal points in water quality improvement.

Additional opportunities for water quality improvement are both ongoing and anticipated. Historically, a great deal of research into mine drainage has been conducted by DEP's Bureau of Abandoned Mine Reclamation, which administers and oversees the Abandoned Mine Reclamation Program in Pennsylvania; the United States Office of Surface Mining; the National Mine Land Reclamation Center; the National Environmental Training Laboratory; and many other agencies and individuals. Funding from EPA's CWA Section 319(a) Grant program and Pennsylvania's Growing Greener program has been used extensively to remedy mine drainage impacts. These many activities are expected to continue and result in water quality improvement.

The DEP Bureau of Mining and Reclamation administers an environmental regulatory program for all mining activities, mine subsidence regulation, mine subsidence insurance, and coal refuse disposal; conducts a program to ensure safe underground bituminous mining and protect certain structures from subsidence; administers a mining license and permit program; administers a regulatory program for the use, storage, and handling of explosives; provides for training, examination, and certification of applicants for blaster's licenses; administers a loan program for bonding anthracite underground mines and for mine subsidence; and administers the EPA Watershed Assessment Grant Program, the Small Operator's Assistance Program (SOAP), and the Remining Operators Assistance Program (ROAP).

Mine reclamation and well plugging refers to the process of cleaning up environmental pollutants and safety hazards associated with a site and returning the land to a productive condition, similar to DEP's Brownfields program. Since the 1960s, Pennsylvania has been a national leader in establishing laws and regulations to ensure reclamation and plugging occur after active operation is completed.

Pennsylvania is striving for complete reclamation of its abandoned mines and plugging of its orphaned wells. Realizing this task is no small order, DEP has developed concepts to make abandoned mine reclamation easier. These concepts, collectively called Reclaim PA, include legislative, policy land management initiatives designed to enhance mine operator, volunteer land DEP reclamation efforts. Reclaim PA has the following four objectives.

- To encourage private and public participation in abandoned mine reclamation efforts
- To improve reclamation efficiency through better communication between reclamation partners
- To increase reclamation by reducing remining risks

- To maximize reclamation funding by expanding existing sources and exploring new sources.

Reclaim PA is DEP's initiative designed to maximize reclamation of the state's quarter million acres of abandoned mineral extraction lands. Abandoned mineral extraction lands in Pennsylvania constituted a significant public liability – more than 250,000 acres of abandoned surface mines, 2,400 miles of streams polluted with mine drainage, over 7,000 orphaned and abandoned oil and gas wells, widespread subsidence problems, numerous hazardous mine openings, mine fires, abandoned structures and affected water supplies – representing as much as one third of the total problem nationally.

### **Public Participation**

Public notice of the draft TMDL was published in the *Pennsylvania Bulletin* on November 6, 2004, *The Tribune Democrat* on November 1, 2004 and the *Nanty Glo Journal* on November 3, 2004 to foster public comment on the allowable loads calculated. The public comment period on this TMDL was open from November 6, 2004 to January 6, 2005. A public meeting was held on November 16, 2004 at the Nanty Glo Firehall in Nanty Glo, PA to discuss the proposed TMDL.

# **Attachment A**

## **South Branch Blacklick Creek Watershed Maps**

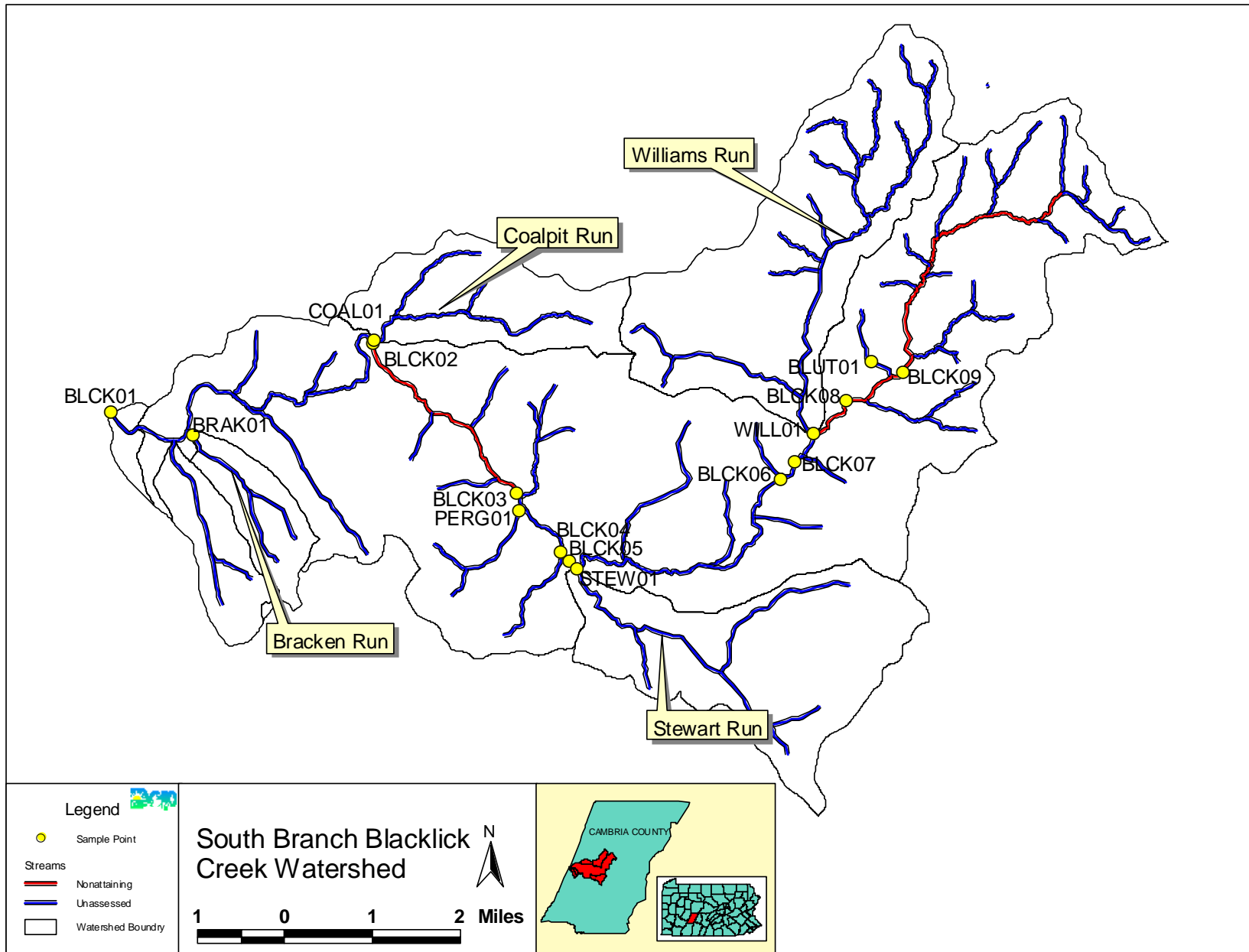

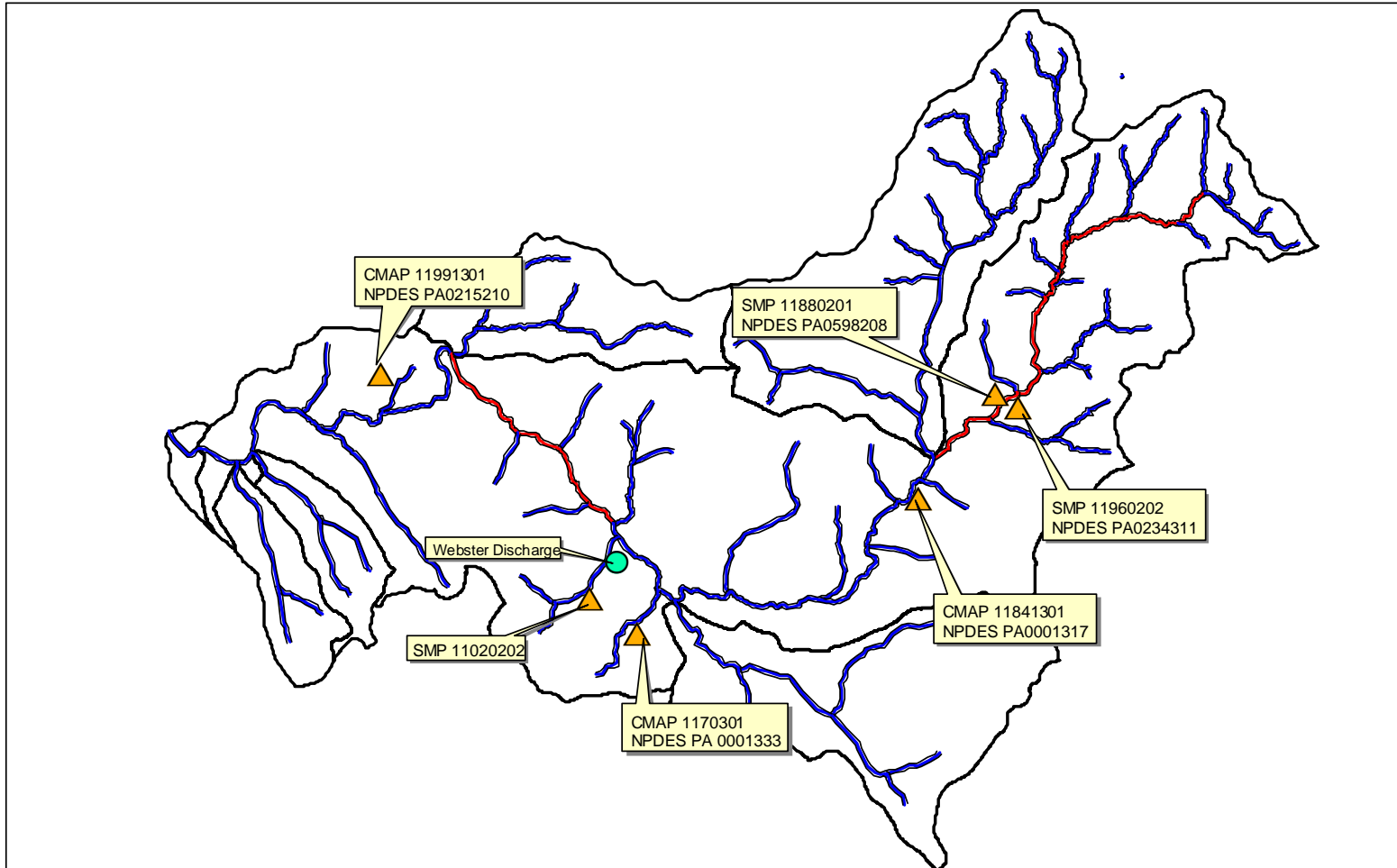

CMAP 11991301  
NPDES PA0215210

SMP 11880201  
NPDES PA0598208

Webster Discharge

SMP 11960202  
NPDES PA0234311

SMP 11020202

CMAP 11841301  
NPDES PA0001317



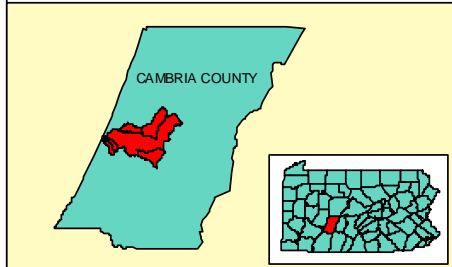

CMAP 1170301  
NPDES PA 0001333

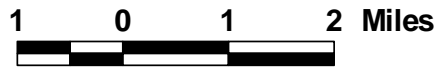

## South Branch Blacklick Creek Active Mine Sites



### Legend

-  Mine Site
-  Abandoned Discharge
- Streams**
-  Nonattaining
-  Unassessed
-  Watershed Boundry



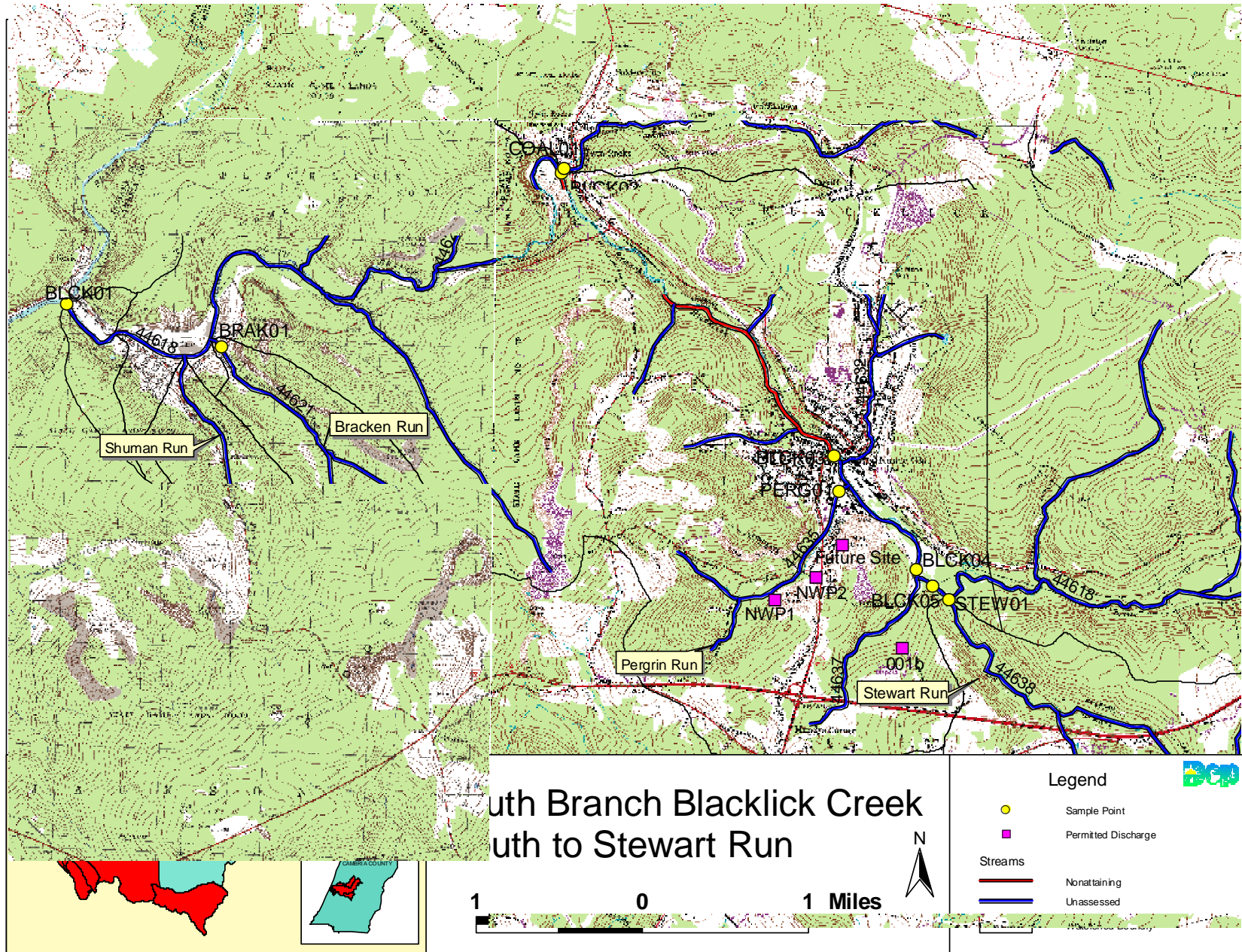



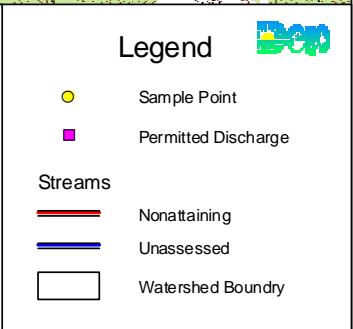
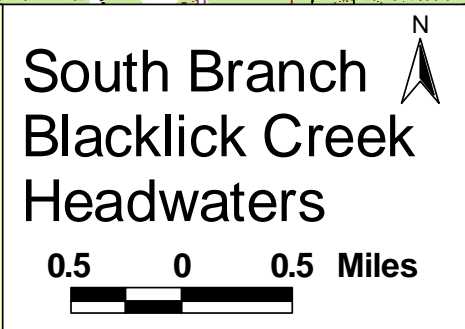
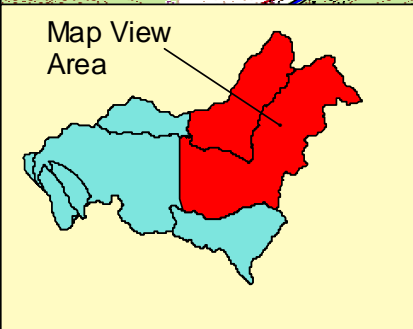
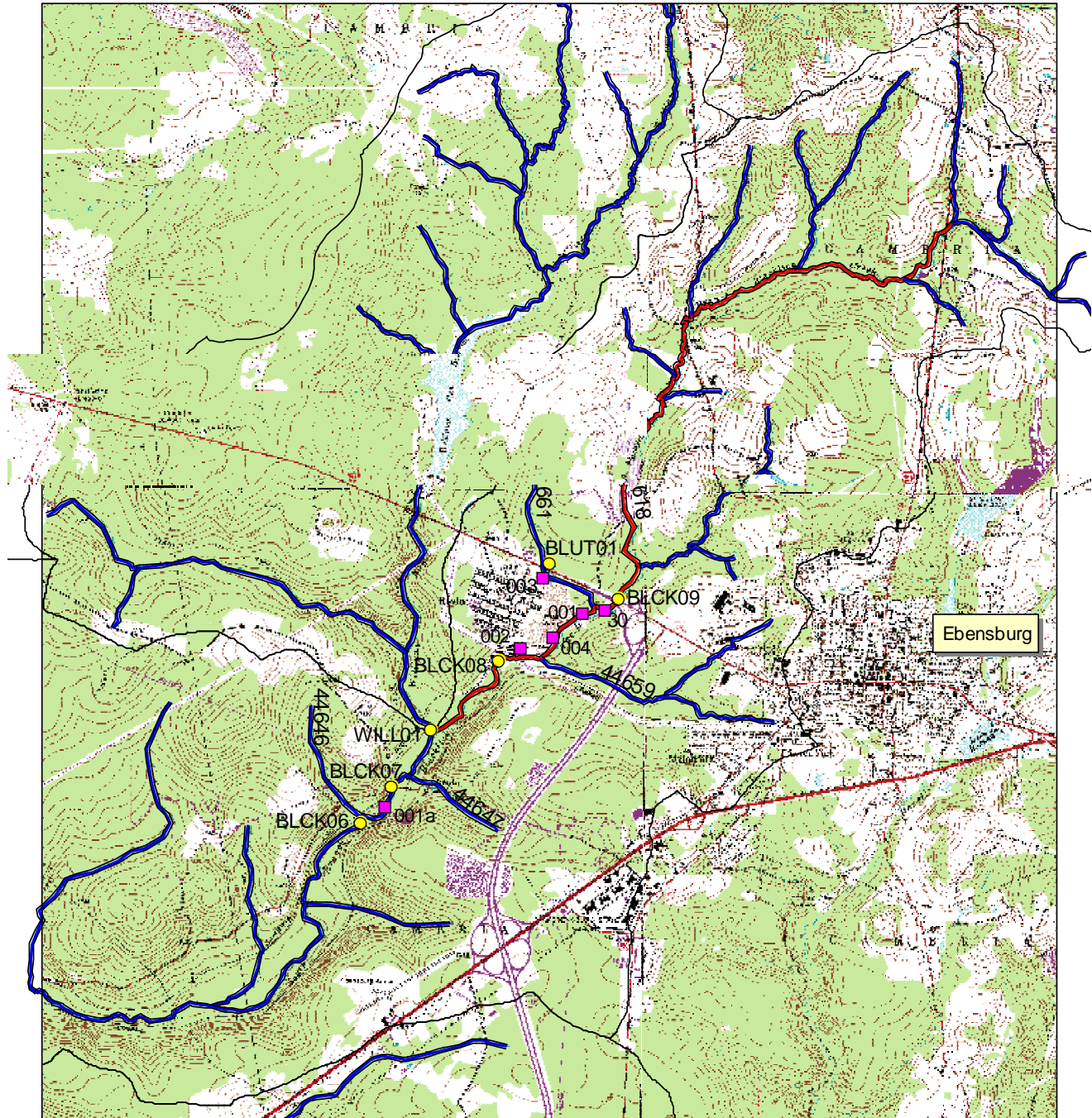

# South Branch Segment Map

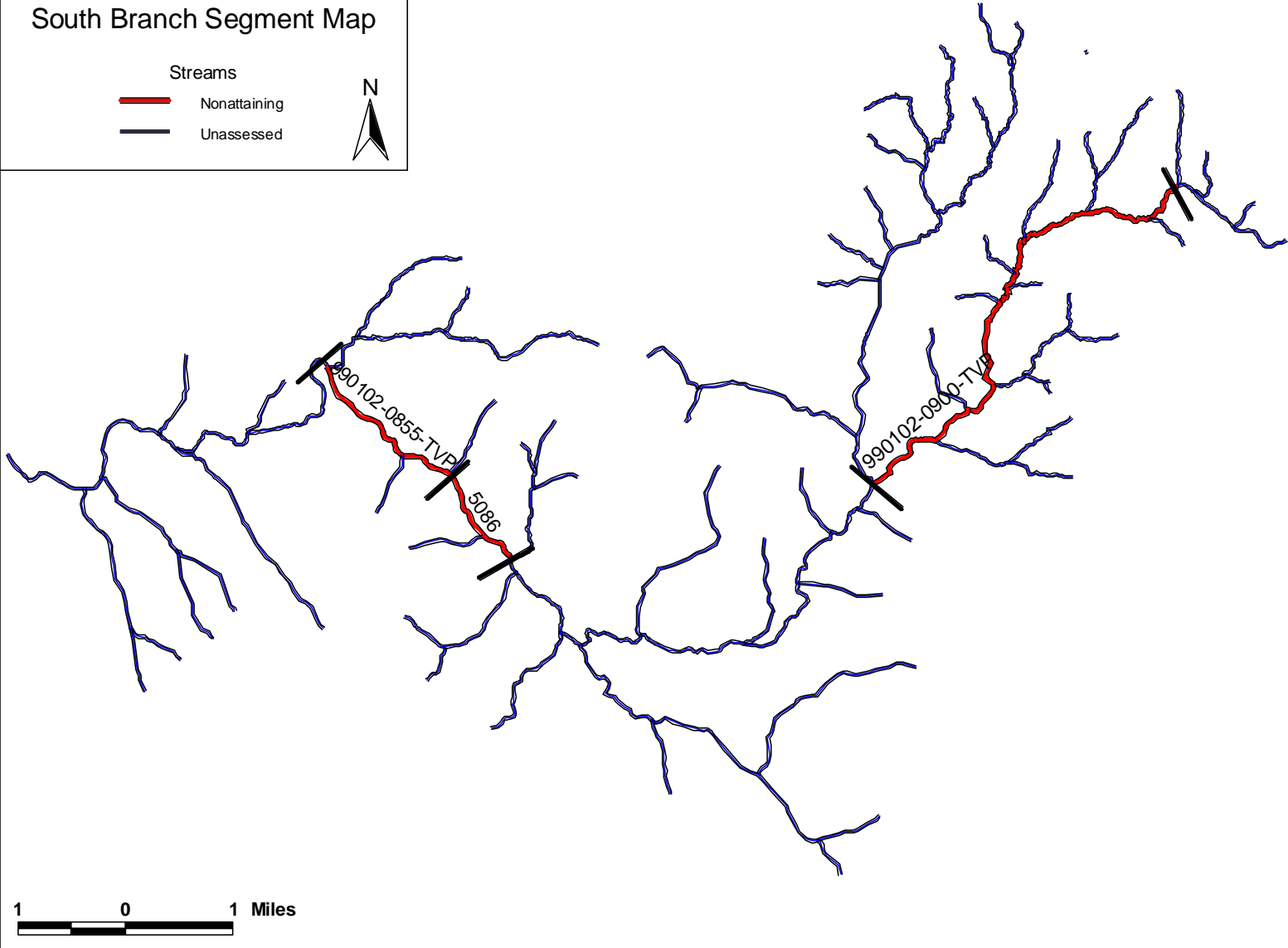
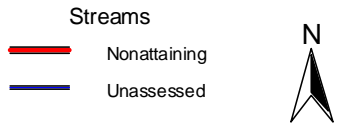

### Sampling Station Diagram South Branch Blacklick Creek Above Stewart Run

Arrows indicate direction of flow.

(Diagram not to scale)

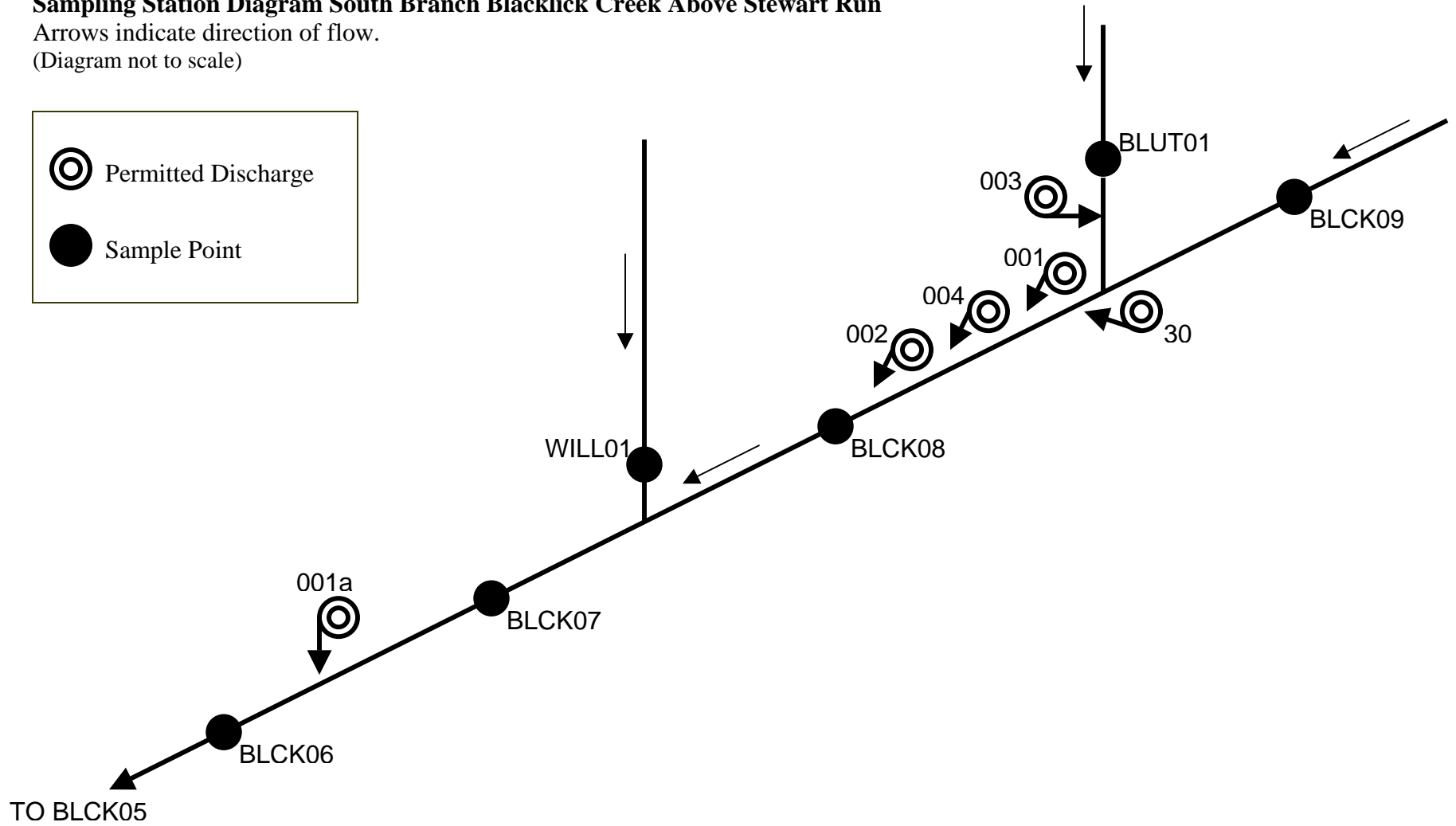
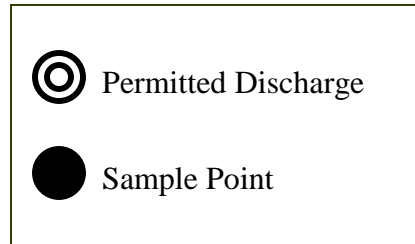

**Sampling Station Diagram South Branch Blacklick Creek Between Stewart Run and just downstream of Pergrin Run**

Arrows indicate direction of flow.

(Diagram not to scale)

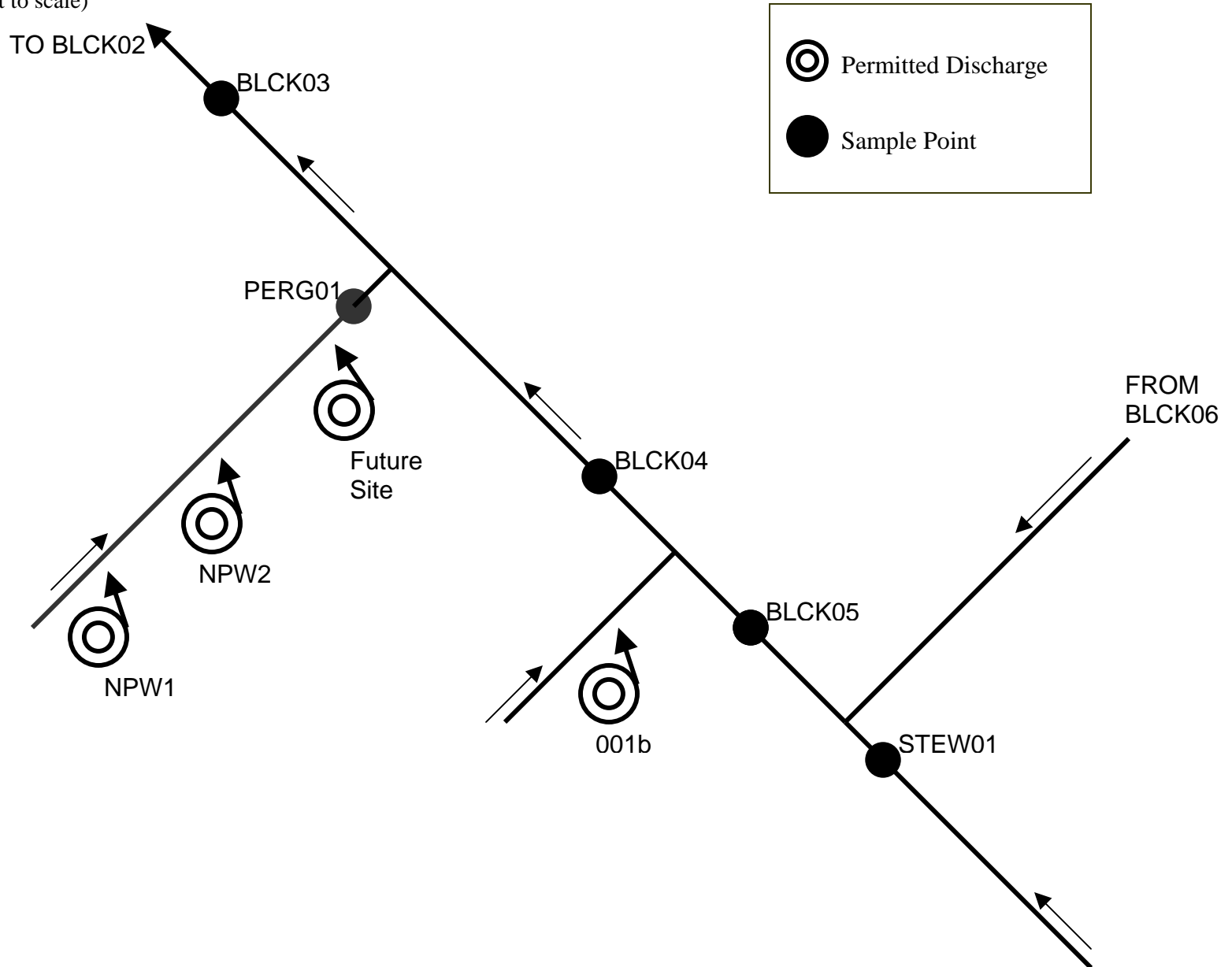

### Sampling Station Diagram South Branch Blacklick Creek Between the mouth and Coalpit Run

Arrows indicate direction of flow.

(Diagram not to scale)

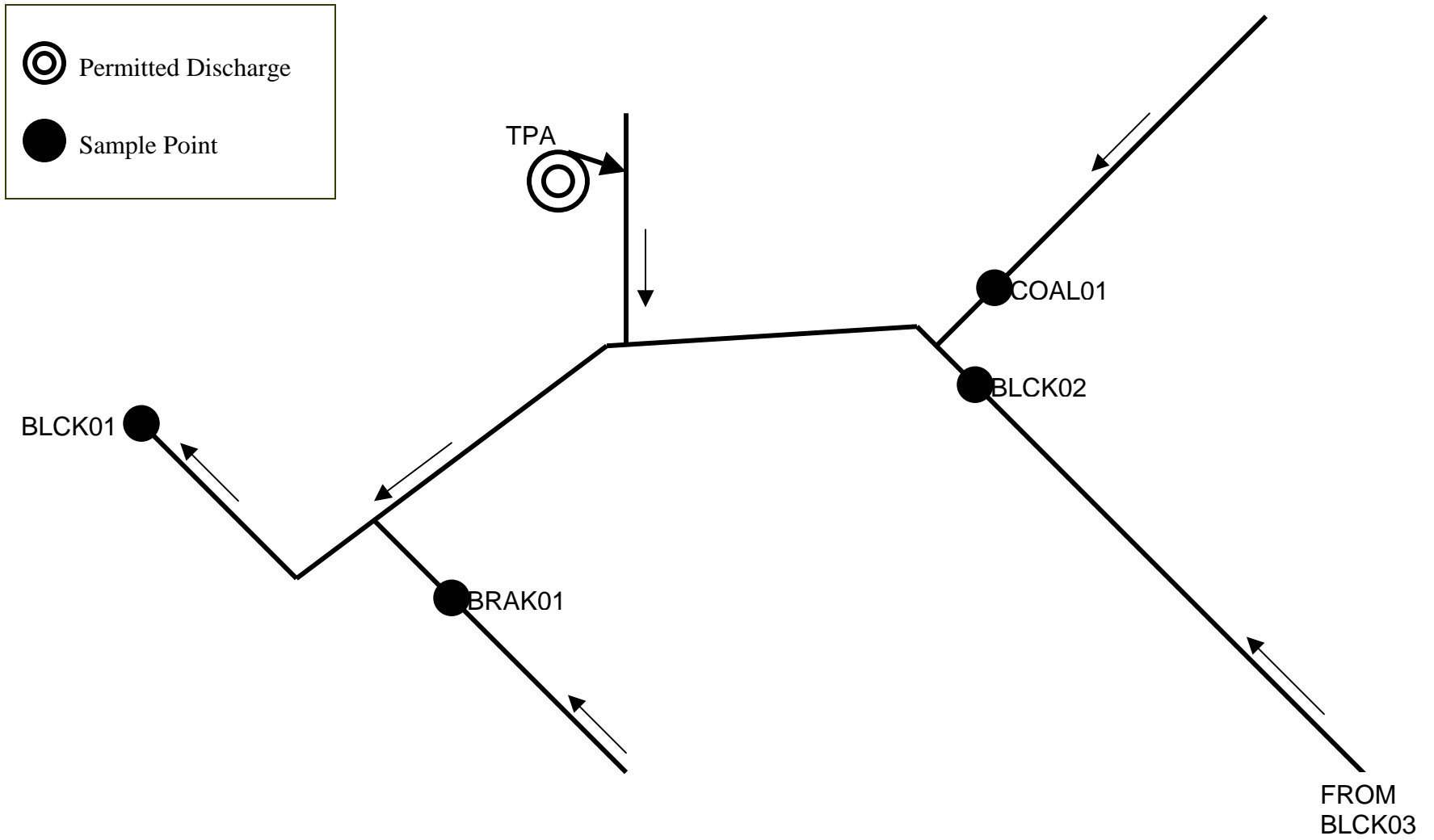

# **Attachment B**

**Method for Addressing Section 303(d) Listings for pH**

# Method for Addressing Section 303(d) Listings for pH

There has been a great deal of research conducted on the relationship between alkalinity, acidity, and pH. Research published by the Pa. Department of Environmental Protection demonstrates that by plotting net alkalinity (alkalinity-acidity) vs. pH for 794 mine sample points, the resulting pH value from a sample possessing a net alkalinity of zero is approximately equal to six (Figure 1). Where net alkalinity is positive (greater than or equal to zero), the pH range is most commonly six to eight, which is within the EPA's acceptable range of six to nine and meets Pennsylvania water quality criteria in Chapter 93.

The pH, a measurement of hydrogen ion acidity presented as a negative logarithm, is not conducive to standard statistics. Additionally, pH does not measure latent acidity. For this reason, and based on the above information, Pennsylvania is using the following approach to address the stream impairments noted on the Section 303(d) list due to pH. The concentration of acidity in a stream is at least partially chemically dependent upon metals. For this reason, it is extremely difficult to predict the exact pH values, which would result from treatment of abandoned mine drainage. Therefore, net alkalinity will be used to evaluate pH in these TMDL calculations. This methodology assures that the standard for pH will be met because net alkalinity is a measure of the reduction of acidity. When acidity in a stream is neutralized or is restored to natural levels, pH will be acceptable. Therefore, the measured instream alkalinity at the point of evaluation in the stream will serve as the goal for reducing total acidity at that point. The methodology that is applied for alkalinity (and therefore pH) is the same as that used for other parameters such as iron, aluminum, and manganese that have numeric water quality criteria.

Each sample point used in the analysis of pH by this method must have measurements for total alkalinity and total acidity. Net alkalinity is alkalinity minus acidity, both being in units of milligrams per liter (mg/l) CaCO<sub>3</sub>. The same statistical procedures that have been described for use in the evaluation of the metals is applied, using the average value for total alkalinity at that point as the target to specify a reduction in the acid concentration. By maintaining a net alkaline stream, the pH value will be in the range between six and eight. This method negates the need to specifically compute the pH value, which for mine waters is not a true reflection of acidity. This method assures that Pennsylvania's standard for pH is met when the acid concentration reduction is met.

There are several documented cases of streams in Pennsylvania having a natural background pH below six. If the natural pH of a stream on the Section 303(d) list can be established from its upper unaffected regions, then the pH standard will be expanded to include this natural range. The acceptable net alkalinity of the stream after treatment/abatement in its polluted segment will be the average net alkalinity established from the stream's upper, pristine reaches added to the acidity of the polluted portion in question. Summarized, if the pH in an unaffected portion of a stream is found to be naturally occurring below six, then the average net alkalinity for that portion (added to the acidity of the polluted portion) of the stream will become the criterion for the polluted portion. This "natural net alkalinity level" will be the criterion to which a 99 percent confidence level will be applied. The pH range will be varied only for streams in which a natural unaffected net alkalinity level can be established. This can only be done for streams that have upper segments that are not impacted by mining activity. All other streams will be required to reduce the acid load so the net alkalinity is greater than zero 99% of time.

Reference: *Rose, Arthur W. and Charles A. Cravotta, III 1998. Geochemistry of Coal Mine Drainage. Chapter 1 in Coal Mine Drainage Prediction and Pollution Prevention in Pennsylvania. Pa. Dept. of Environmental Protection, Harrisburg, Pa.*

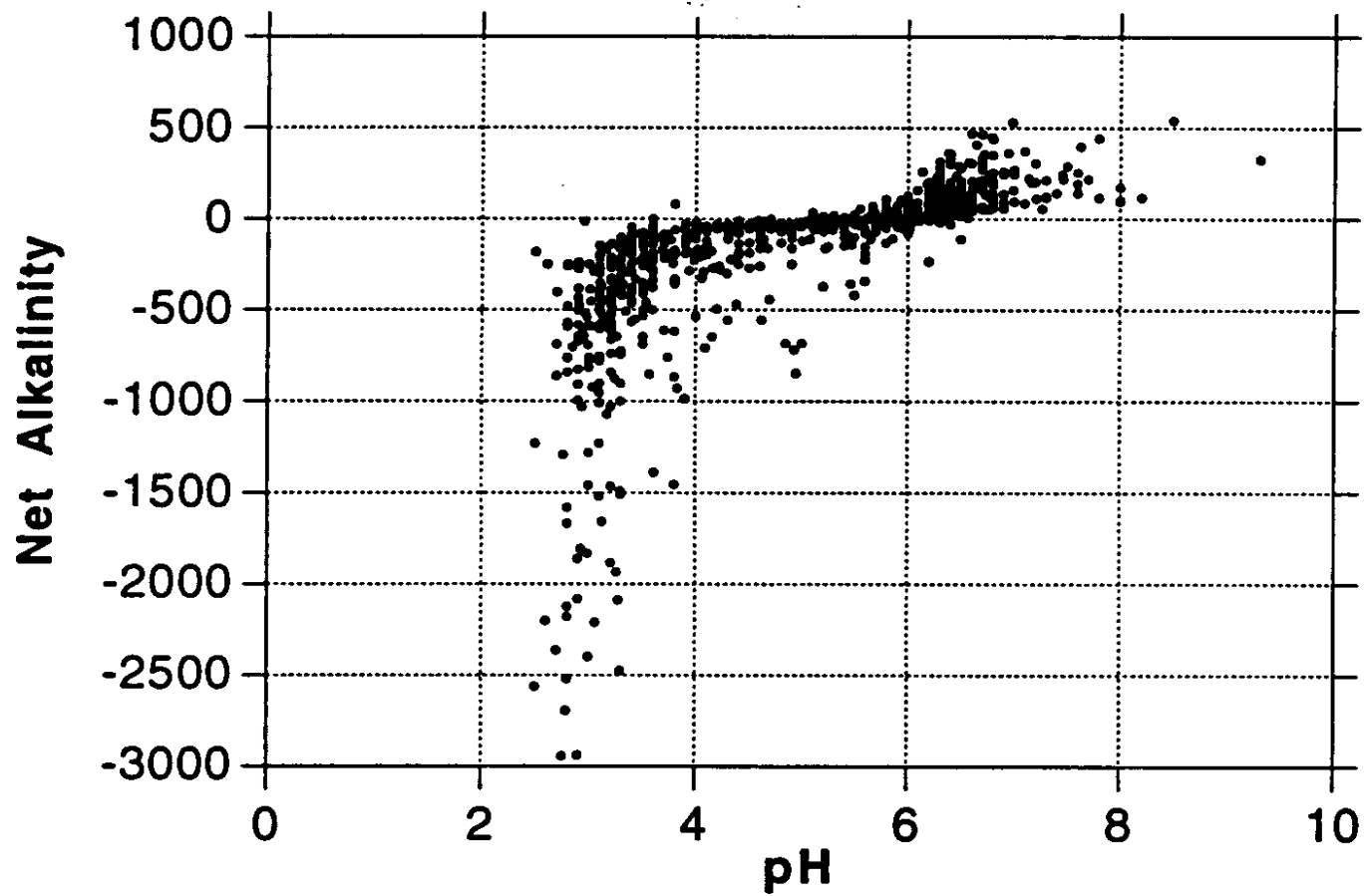

**Figure 1.** Net Alkalinity vs. pH. Taken from Figure 1.2 Graph C, pages 1-5, of Coal Mine Drainage Prediction and Pollution Prevention in Pennsylvania



# **Attachment C**

## **TMDLs By Segment**

## **South Branch Blacklick Creek**

The TMDL for South Branch Blacklick Creek consists of load allocations of six tributaries and nine sampling sites along the stream. Waste load allocations are assigned to ten permitted discharges and one potential future discharge.

South Branch Blacklick Creek is listed as impaired on the PA Section 303(d) list by both high metals and low pH from AMD. The method and rationale for addressing pH is contained in Attachment B. For pH, the objective is to reduce acid loading to the stream which will in turn raise the pH to the acceptable range. The result of this analysis is an acid loading reduction that equates to meeting standards for pH (see TMDL Endpoint section in the report, Table 2).

An allowable long-term average in-stream concentration was determined at each sample point for aluminum, iron, manganese, and acidity. The analysis is designed to produce an average value that, when met, will be protective of the water-quality criterion for that parameter 99% of the time. An analysis was performed using Monte Carlo simulation to determine the necessary long-term average concentration needed to attain water-quality criteria 99% of the time. The simulation was run assuming the data set was lognormally distributed. Using the mean and standard deviation of the data set, five thousand iterations of sampling were completed, and compared against the water-quality criterion for that parameter. For each sampling event a percent reduction was calculated, if necessary, to meet water-quality criteria. A second simulation that multiplied the percent reduction times the sampled value was run to insure that criteria were met 99% of the time. The mean value from this data set represents the long-term average concentration that needs to be met to achieve water-quality standards.

At some points the allowable loads calculated are less than the upstream loads entering the segment. The lower allowable load is caused by increases in load and greater data variations within a segment that result in the simulation calculating a low allowable load. It is assumed that with treatment, water quality standards will be met.

### ***TMDL Calculations - Sample Point BLCK09, South Branch upstream of Revloc***

The TMDL for sample point BLCK09 consists of a load allocation to all of the area above the point (Attachment A). The load allocation for this segment was computed using water-quality sample data collected at point BLCK09. The average flow of 4.72 MGD, measured at the point, is used for these computations.

This segment was included on the 2002 PA Section 303(d) list for metals and pH impairments from AMD. Sample data at point BLCK09 shows pH ranging between 6.09 and 6.98. Water quality analysis determined that the WQS is not met 99% of the time; pH will be addressed as part of this TMDL.

The simulation determined that the measured aluminum load is equal to the allowable load. Because the WQS is met, a TMDL for aluminum is not necessary. Although a TMDL is not necessary, the aluminum loading is considered at the next downstream point, BLCK08.

<b>Table C1. TMDL Calculations at Point BLCK09</b>				
Flow = 4.72 MGD	Measured Sample Data		Allowable	
Parameter	Conc. (mg/l)	Load (lbs/day)	LTA Conc. (mg/l)	Load (lbs/day)
Fe	0.95	25,940	0.37	10,117
Mn	0.27	7,415	0.21	5,783
Al	0.19	5,327	0.19	5,327
Acidity	14.70	401,815	7.94	216,980
Alkalinity	25.70	702,421		

<b>Table C2. Calculation of Load Reduction Necessary at Point BLCK09</b>				
	Fe (lbs/day)	Mn (lbs/day)	Al (lbs/day)	Acidity (lbs/day)
Existing Load	25,940	7,415	5,327	401,815
Allowable Load	10,117	5,783	5,327	216,980
Load Reduction	15,824	1,631	0	184,835
Total % Reduction	61	22	0	46

### ***TMDL Calculations - Sampling Point BLUT01, Unnamed Tributary 44661***

The TMDL for sample point BLUT01 consists of a load allocation to all of the area above the point (Attachment A). The load allocation for this tributary was computed using water-quality sample data collected at point BLUT01. The average flow of 0.26 MGD, measured at the point, is used for these computations.

This segment is not included on the PA Section 303(d) list. Sample data at point BLUT01 shows pH ranging between 5.46 and 6.46; pH will be addressed as part of this TMDL.

The simulation determined that the measured iron and manganese loads are equal to the allowable loads. Because the WQS is met, TMDLs for iron and manganese are not necessary. Although TMDLs are not necessary, the loadings are considered at the next downstream point, BLCK08.

<b>Table C3. TMDL Calculations at Point BLUT01</b>				
Flow = 0.26 MGD	Measured Sample Data		Allowable	
Parameter	Conc. (mg/l)	Load (lbs/day)	LTA Conc. (mg/l)	Load (lbs/day)
Fe	0.14	206	0.14	206
Mn	0.24	359	0.24	359
Al	0.57	843	0.28	413
Acidity	6.66	9,863	3.13	4,635
Alkalinity	8.27	12,251		

<b>Table C4. Calculation of Load Reduction Necessary at Point BLUT01</b>				
	Fe (lbs/day)	Mn (lbs/day)	Al (lbs/day)	Acidity (lbs/day)
Existing Load	206	359	843	9,863
Allowable Load	206	359	413	4,635
Load Reduction	0	0	430	5,227
Total % Reduction	0	0	51	53

**Waste Load Allocation – Discharges 001, 002, 003, 004, and 30**

The waste load allocation for the Revloc #2 site (discharge 30) is calculated using measured average flow and average monthly permit limits. For discharges 001, 002, 003, and 004 on the Revloc site, measured flows are not available. The Revloc and Revloc #2 operations are similar and it is expected that flows from both sites are approximately equal. The waste load allocations for 001, 002, 003, and 004 are calculated using the average flow from discharge 30 on the Revloc #2 site and average monthly permit limits. Waste load allocations for the two mining operations are incorporated into the calculations at BLCK08. For both operations this is the first downstream monitoring point that receives all the potential flow of treated water from the two individual sites. The following table shows the waste load allocations for the discharges.

<b>Table C5. Waste Load Allocations Revloc and Revloc #2 Sites</b>				
Discharge	Parameter	Monthly Avg. Allowable Conc. (mg/L)	Average Flow (MGD)	WLA (lbs/day)
<i>Ebensburg Power Co., SMP 11880201, Revloc Refuse Site, NPDES PA0598208</i>				
001	Fe	3.0	0.001	0.02
	Mn	2.0	0.001	0.01
	Al	1.3	0.001	0.01
002	Fe	3.0	0.001	0.02
	Mn	2.0	0.001	0.01
	Al	1.3	0.001	0.01
003	Fe	3.0	0.001	0.02
	Mn	2.0	0.001	0.01
	Al	1.3	0.001	0.01
004	Fe	3.0	0.001	0.02
	Mn	2.0	0.001	0.01
	Al	1.3	0.001	0.01
<i>Ebensburg Power Co., SMP 11960202, Revloc #2 Refuse Site, NPDES PA0234311</i>				
30	Fe	3.0	0.001	0.02
	Mn	2.0	0.001	0.01
	Al	2.0	0.001	0.01

***TMDL Calculations - Sample Point BLCK08, South Branch downstream of Revloc***

The TMDL for sample point BLCK08 consists of a four waste load allocations and a load allocation to all of the area between sample points BLCK08, BLUT01 and BLCK09 shown in Attachment A. The TMDL for this stream segment was computed using water-quality sample data collected at point BLCK08. The average flow of 6.91 MGD, measured at the sampling point, is used for these computations.

This segment was included on the 2002 PA Section 303(d) list for metals and pH impairments from AMD. Sample data at point BLCK08 shows pH ranging between 4.35 and 6.20; pH will be addressed as part of this TMDL because of the mining impacts.

<b>Table C6. TMDL Calculations at Point BLCK08</b>				
Flow = 6.91 MGD	Measured Sample Data		Allowable	
Parameter	Conc. (mg/l)	Load (lbs/day)	LTA Conc. (mg/l)	Load (lbs/day)
Fe	1.13	45,396	0.61	24,514
Mn	0.89	35,601	0.22	8,900
Al	7.42	296,940	0.15	5,939
Acidity	40.39	1,617,361	1.21	48,521
Alkalinity	6.75	270,254		

The calculated load reductions for all the loads that enter point BLCK08 must be accounted for in the calculated reductions at the sample point shown in Table C7. A comparison of measured loads between points BLCK08, BLCK09 and BLUT01 shows that there is additional loading entering the segment for all parameters. The total segment load is the sum of the loads tracked from upstream points and the additional loading entering the segment.

Because the total segment WLAs, 0.08 for iron and 0.04 for manganese and aluminum, are small in comparison to the allowable segment load, the total segment WLAs are rounded up to the next whole pound.

<b>Table C7. Calculation of Load Reduction Necessary at Point BLCK08</b>				
	Fe (lbs/day)	Mn (lbs/day)	Al (lbs/day)	Acidity (lbs/day)
Measured Load	45,396	35,601	296,940	1,617,361
Difference in Measured Loads	19,250	27,828	290,770	1,205,684
Load tracked from upstream	10,323	6,142	5,740	221,615
Total Load tracked between points	29,573	33,970	296,510	1,427,299
Allowable Load at BLCK08	24,514	8,900	5,939	48,521
Allowable Load assigned to WLA	1	1	1	0
Allowable Load assigned to LA	24,513	8,899	5,938	48,521
Load Reduction at BLCK08	5,059	25,070	290,571	1,378,778
% Reduction required at BLCK08	17	74	98	97

***TMDL Calculations - Sample Point WILL01, mouth of Williams Run***

The TMDL for sample point WILL01 consists of a load allocation to all of the area above the point (Attachment A). The load allocation for this tributary was computed using water-quality sample data collected at point WILL01. The average flow of 8.01 MGD, measured at the point, is used for these computations.

This segment is not included on the PA Section 303(d) list. Sample data at point WILL01 shows pH ranging between 5.71 and 7.15; pH will be addressed as part of this TMDL.

The simulation determined that the measured iron, aluminum, and manganese loads are equal to the allowable loads. Because WQS are met, TMDLs for iron, aluminum, and manganese are not necessary. Although TMDLs are not necessary, the loadings are considered at the next downstream point, BLCK07.

<b>Table C8. TMDL Calculations at Point WILL01</b>				
Flow = 8.01 MGD	Measured Sample Data		Allowable	
Parameter	Conc. (mg/l)	Load (lbs/day)	LTA Conc. (mg/l)	Load (lbs/day)
Fe	0.31	14,549	0.31	14,549
Mn	0.051	2,342	0.05	2,342
Al	0.089	4,119	0.09	4,119
Acidity	5.30	245,662	1.91	8,8438
Alkalinity	10.31	478,321		

<b>Table C9. Calculation of Load Reduction Necessary at Point WILL01</b>				
	Fe (lbs/day)	Mn (lbs/day)	Al (lbs/day)	Acidity (lbs/day)
Measured Load	14,549	2,342	4,119	245,662
Allowable Load	14,549	2,342	4,119	88,438
Load Reduction	0	0	0	157,224
Total % Reduction	0	0	0	64

***TMDL Calculations - Sample Point BLCK07, South Branch downstream of Unnamed Tributary 44647***

The TMDL for sample point BLCK07 consists of a load allocation to all of the area between sample points BLCK07, WILL01, and BLCK08 shown in Attachment A. The TMDL for this stream segment was computed using water-quality sample data collected at point BLCK07. The average flow of 16.89 MGD, measured at the sampling point, is used for these computations.

This segment was included on the 2002 PA Section 303(d) list for metals and pH impairments from AMD. Sample data at point BLCK07 shows pH ranging between 5.38 and 6.82; pH will be addressed as part of this TMDL because of the mining impacts.

The simulation determined that the measured iron load is equal to the allowable iron load. Because the WQS is met, a TMDL is not necessary for iron at BLCK07. Although a TMDL is not necessary, the measured load is considered at the next downstream point, BLCK06.

<b>Table C10. TMDL Calculations at Point BLCK07</b>				
Flow = 16.89 MGD	Measured Sample Data		Allowable	
Parameter	Conc. (mg/l)	Load (lbs/day)	LTA Conc. (mg/l)	Load (lbs/day)
Fe	0.31	30,685	0.31	30,685
Mn	0.39	38,042	0.25	24,347
Al	0.96	93,831	0.35	34,718
Acidity	6.31	617,243	2.34	228,380
Alkalinity	11.22	1,097,108		

The calculated load reductions for all the loads that enter point BLCK07 must be accounted for in the calculated reductions at the sample point shown in Table C11. A comparison of measured loads between points BLCK07, BLCK08 and WILL01 shows that there is additional loading entering the segment for manganese and a loss of loading for iron, aluminum, and acidity. The total segment manganese load is the sum of the loads tracked from upstream points and the additional loading entering the segment. For loss of iron, aluminum, and acidity load, the percent of load lost within the segment is calculated and applied to the upstream loads to determine the amount of the upstream load that is tracked through the segment.

<b>Table C11. Calculation of Load Reduction Necessary at Point BLCK07</b>				
	Fe (lbs/day)	Mn (lbs/day)	Al (lbs/day)	Acidity (lbs/day)
Measured Load	30,685	38,042	93,831	617,243
Difference in Measured Load	-29,261	99	-207,228	-1,245,781
Load tracked from upstream	39,063	11,242	10,058	136,959
% Load lost	49	-	69	67
% Load tracked	51	-	31	33
Total Load tracked	19,995	11,341	3,135	45,376
Allowable Load at BLCK07	30,685	24,347	34,718	228,380
Load Reduction at BLCK07	0.0	0.0	0.0	0.0
% Reduction required at BLCK07	0	0	0	0

### ***Waste Load Allocation – Discharge 001a***

The waste load allocation for the Cambria Slope Mine 33 site (discharge 001a) is calculated using measured average flow and average monthly permit limits. The waste load allocation for the mining operation is incorporated into the calculations at BLCK06. This is the first downstream monitoring point that receives all the potential flow of treated water from the site. The following table shows the waste load allocation for the discharge.

<b>Table C12. Waste Load Allocation Cambria Slope Mine 33</b>				
<b>Discharge</b>	<b>Parameter</b>	<b>Monthly Avg. Allowable Conc. (mg/L)</b>	<b>Average Flow (MGD)</b>	<b>WLA (lbs/day)</b>
<i>Beth Energy Mines, Inc., CMAP 11841301, Cambria Slope Mine 33, PA0001317</i>				
001a	Fe	3.0	0.578	14.5
	Mn	2.0	0.578	9.6
	Al	2.0	0.578	9.6

### ***TMDL Calculations - Sample Point BLCK06, South Branch downstream of Unnamed Tributary 44646***

The TMDL for sample point BLCK06 consists of a waste load allocation and a load allocation to all of the area between sample points BLCK06 and BLCK07 shown in Attachment A. The TMDL for this stream segment was computed using water-quality sample data collected at point BLCK06. The average flow of 17.00 MGD, measured at the sampling point, is used for these computations.

This segment is not included on the PA Section 303(d) list. Sample data at point BLCK06 shows pH ranging between 5.56 and 6.86; pH will be addressed as part of this TMDL.

The simulation determined that the measured iron load is equal to the allowable iron load. Because the WQS is met, a TMDL is not necessary for iron at BLCK06. Although a TMDL is not necessary, the measured load is considered at the next downstream point.

<b>Table C13. TMDL Calculations at Point BLCK06</b>				
<b>Flow = 17.00 MGD</b>	<b>Measured Sample Data</b>		<b>Allowable</b>	
<b>Parameter</b>	<b>Conc. (mg/l)</b>	<b>Load (lbs/day)</b>	<b>LTA Conc. (mg/l)</b>	<b>Load (lbs/day)</b>
Fe	0.33	32,216	0.33	32,216
Mn	0.37	35,974	0.23	23,023
Al	0.78	77,194	0.20	19,299
Acidity	8.06	793,835	2.18	214,335
Alkalinity	11.29	1,111,737		



The calculated load reductions for all the loads that enter point BLCK06 must be accounted for in the calculated reductions at the sample point shown in Table C14. A comparison of measured loads between points BLCK06 and BLCK07 shows that there is additional loading entering the segment for iron and acidity and a loss of loading for aluminum and manganese. The total segment iron and acidity load are the sum of the loads tracked from upstream points and the additional loading entering the segment. For loss of aluminum and manganese load, the percent of load lost within the segment is calculated and applied to the upstream loads to determine the amount of the upstream load that is tracked through the segment.

Because the total segment WLAs are small in comparison to the allowable segment load, the total segment WLAs are rounded up to the next whole pound.

<b>Table C14. Calculation of Load Reduction Necessary at Point BLCK06</b>				
	Fe (lbs/day)	Mn (lbs/day)	Al (lbs/day)	Acidity (lbs/day)
Measured Load	32,216	35,974	77,194	793,835
Difference in Measured Load	1,531	-2,068	-16,637	176,592
Load tracked from upstream	19,995	11,341	3,135	45,376
% Load lost	-	5	18	-
% Load tracked	-	95	82	-
Total Load tracked	21,527	10,724	2,579	221,968
Allowable Load at BLCK06	32,216	23,023	19,299	214,335
Allowable Load assigned to WLA	15	10	10	0
Allowable Load assigned to LA	32,201	23,014	19,289	214,335
Load Reduction at BLCK06	0	0	0	7,633
% Reduction required at BLCK06	0	0	0	3

### ***TMDL Calculations - Sample Point STEW01, mouth of Stewart Run***

The TMDL for sample point STEW01 consists of a load allocation to all of the area above the point (Attachment A). The load allocation for this tributary was computed using water-quality sample data collected at point STEW01. The average flow of 6.28 MGD, measured at the point, is used for these computations.

This segment is not included on the PA Section 303(d) list. Sample data at point STEW01 shows pH ranging between 6.16 and 7.89; pH will not be addressed as part of this TMDL.

The simulation determined that the measured iron, aluminum, manganese, and acidity loads are equal to the allowable loads. Because the WQS is met, TMDLs for iron, aluminum, manganese, and acidity are not necessary. Although TMDLs are not necessary, the loadings are considered at the next downstream point, BLCK05.

<b>Table C15. TMDL Calculations at Point STEW01</b>				
Flow = 6.28 MGD	Measured Sample Data		Allowable	
Parameter	Conc. (mg/l)	Load (lbs/day)	LTA Conc. (mg/l)	Load (lbs/day)
Fe	0.22	8,154	0.22	8,154
Mn	0.030	1,087	0.030	1,087
Al	0.059	2,130	0.059	2,130
Acidity	12.45	452,643	12.45	452,643
Alkalinity	25.56	929,255		

<b>Table C16. Calculation of Load Reduction Necessary at Point STEW01</b>				
	Fe (lbs/day)	Mn (lbs/day)	Al (lbs/day)	Acidity (lbs/day)
Measured Load	8,154	1,087	2,130	452,643
Allowable Load	8,154	1,087	2,130	452,643
Load Reduction	0	0	0	0
Total % Reduction	0	0	0	0

***TMDL Calculations - Sample Point BLCK05, South Branch downstream of Stewart Run***

The TMDL for sample point BLCK05 consists of a load allocation to all of the area between sample points BLCK05, STEW01 and BLCK06 shown in Attachment A. The TMDL for this stream segment was computed using water-quality sample data collected at point BLCK05. The average flow of 29.07 MGD, measured at the sampling point, is used for these computations.

This segment is not included on the PA Section 303(d) list. Sample data at point BLCK05 shows pH ranging between 6.00 and 7.26. The simulation determined that the WQS in not met 99% of the time; pH will be addressed as part of this TMDL.

The simulation determined that the measured iron and manganese loads are equal to the allowable iron and manganese loads. Because WQS are met, TMDLs are not necessary for iron and manganese at BLCK05. Although TMDLs are not necessary, upstream loads are tracked through the segment to the next downstream point, BLCK04.

<b>Table C17. TMDL Calculations at Point BLCK05</b>				
Flow = 29.07 MGD	Measured Sample Data		Allowable	
Parameter	Conc. (mg/l)	Load (lbs/day)	LTA Conc. (mg/l)	Load (lbs/day)
Fe	0.32	53,854	0.32	53,854
Mn	0.14	24,215	0.14	24,215
Al	0.17	28,542	0.13	21,978
Acidity	10.18	1,713,583	5.39	908,199
Alkalinity	18.83	3,170,269		

The calculated load reductions for all the loads that enter point BLCK05 must be accounted for in the calculated reductions at the sample point shown in Table C18. A comparison of measured loads between points BLCK05, STEW01 and BLCK06 shows that there is additional loading entering the segment for iron and acidity and a loss of loading for aluminum and manganese. The total segment iron and acidity load are the sum of the loads tracked from upstream points and the additional loading entering the segment. For loss of aluminum and manganese load, the percent of load lost within the segment is calculated and applied to the upstream loads to determine the amount of the upstream load that is tracked through the segment.

<b>Table C18. Calculation of Load Reduction Necessary at Point BLCK05</b>				
	Fe (lbs/day)	Mn (lbs/day)	Al (lbs/day)	Acidity (lbs/day)
Measured Load	53,854	24,215	28,542	1,713,583
Difference in Measured Load	13,484	-12,846	-50,782	467,105
Load tracked from upstream	29,680	11,811	4,709	666,978
% Load lost	-	35	64	-
% Load tracked	-	65	36	-
Total Load tracked between points	43,164	7,717	1,695	1,134,083
Allowable Load at BLCK05	53,854	24,215	21,978	908,199
Load Reduction at BLCK05	0.0	0.0	0.0	225,884
% Reduction required at BLCK05	0	0	0	20

### ***Waste Load Allocation – Discharge 001b***

The waste load allocation for the Nanty-Glo Mine 31 site (discharge 001b) is calculated using measured average flow and average monthly permit limits. The waste load allocation for the mining operation is incorporated into the calculations at BLCK04. This is the first downstream monitoring point that receives all the potential flow of treated water from the site. The following table shows the waste load allocation for the discharge.

<b>Table C19. Waste Load Allocation Nanty-Glo Mine 31</b>				
<b>Discharge</b>	<b>Parameter</b>	<b>Monthly Avg. Allowable Conc. (mg/L)</b>	<b>Average Flow (MGD)</b>	<b>WLA (lbs/day)</b>
<i>Beth Energy Mines, Inc. CMAP 11701301, Nanty-Glo Mine 31, NPDES PA0001333</i>				
001b	Fe	3.5	2.739	80.0
	Mn	2.0	2.739	45.7
	Al	2.0	2.739	45.7

***TMDL Calculations - Sample Point BLCK04, South Branch downstream of Unnamed Tributary 44637***

The TMDL for sample point BLCK04 consists of a waste load allocation to the Nanty-Glo Mine 31 site and a load allocation to all of the area between sample points BLCK04 and BLCK05 shown in Attachment A. The TMDL for this stream segment was computed using water-quality sample data collected at point BLCK04. The average flow of 32.58 MGD, measured at the sampling point, is used for these computations.

This segment is not included on the PA Section 303(d) list. Sample data at point BLCK04 shows pH ranging between 5.81 and 7.12; pH will be addressed as part of this TMDL.

The simulation determined that the measured iron and manganese loads are equal to the allowable iron and manganese loads. Because WQS are met, TMDLs are not necessary for iron and manganese at BLCK04. Although TMDLs are not necessary, upstream loads are tracked through the segment to the next downstream point, BLCK03.

<b>Table C20. TMDL Calculations at Point BLCK04</b>				
<b>Flow = 32.58 MGD</b>	<b>Measured Sample Data</b>		<b>Allowable</b>	
<b>Parameter</b>	<b>Conc. (mg/l)</b>	<b>Load (lbs/day)</b>	<b>LTA Conc. (mg/l)</b>	<b>Load (lbs/day)</b>
Fe	0.56	105,768	0.56	105,768
Mn	0.25	47,690	0.25	47,690
Al	0.52	97,498	0.18	34,124
Acidity	8.40	1,585,047	3.44	649,869
Alkalinity	18.26	3,446,246		

The calculated load reductions for all the loads that enter point BLCK04 must be accounted for in the calculated reductions at the sample point shown in Table C21. A comparison of measured loads between points BLCK04 and BLCK05 shows that there is additional loading entering the segment for iron, manganese, and aluminum and a loss of acidity loading. The total segment metals load is the sum of the loads tracked from upstream points and the additional loading entering the segment. For loss of acidity load, the percent of load lost within the segment is

calculated and applied to the upstream loads to determine the amount of the upstream load that is tracked through the segment.

Because the total segment WLAs are small in comparison to the allowable segment load, the total segment WLAs are rounded up to the next whole pound. The upstream acidity load to the segment is greater than the allowable load at BLCK04. It is assumed to be a result of data variability and that standards will be met at BLCK04 with the required upstream reductions.

<b>Table C21. Calculation of Load Reduction Necessary at Point BLCK04</b>				
	Fe (lbs/day)	Mn (lbs/day)	Al (lbs/day)	Acidity (lbs/day)
Measured Load	105,768	47,690	97,498	1,585,047
Difference in Measured Load	51,914	23,475	68,955	-128,536
Load tracked from upstream	43,164	7,717	1,695	908,199
% Load lost	-	-	-	8
% Load tracked	-	-	-	92
Total Load tracked between points	95,079	31,192	70,650	840,075
Allowable Load at BLCK04	105,768	47,690	34,124	649,869
Allowable Load assigned to WLA	80	46	46	0
Allowable Load assigned to LA	105,688	47,644	34,079	649,869
Load Reduction at BLCK04	0	0	36,526	190,206
% Reduction required at BLCK04	0	0	52	23

### ***Waste Load Allocation – Discharges NPW1, NPW2 and Future Site***

The NPDES permit SMP11020202 has not yet been issued and mining has not yet begun and therefore there is no monitoring data available for discharges NPW1 and NPW2. The potential for another mine site in the area is high and therefore load is being allocated for a future mine. These operations will be similar to the operation on the Revloc #2 site and it is expected that flows from both sites will be similar to the flow from discharge 30. The waste load allocations for NPW1, NPW2, and a future site are calculated using the average flow from discharge 30 on the Revloc #2 site and standard BAT average monthly permit limits. Waste load allocations for the two mining operations are incorporated into the calculations at PERG01. For both operations this is the first downstream monitoring point that will receive all the potential flow of treated water from the two individual sites. The following table shows the waste load allocations for the discharges.

<b>Table C22. Waste Load Allocations NPW1, NPW2, and Future Site</b>				
<b>Discharge</b>	<b>Parameter</b>	<b>Monthly Avg. Allowable Conc. (mg/L)</b>	<b>Average Flow (MGD)</b>	<b>WLA (lbs/day)</b>
<i>Ebensburg Power Co., SMP 11020202</i>				
NWP1	Fe	3.0	0.001	0.02
	Mn	2.0	0.001	0.01
	Al	2.0	0.001	0.01
NWP2	Fe	3.0	0.001	0.02
	Mn	2.0	0.001	0.01
	Al	2.0	0.001	0.01
<i>Future Site</i>				
Future Site	Fe	3.0	0.001	0.02
	Mn	2.0	0.001	0.01
	Al	2.0	0.001	0.01

***TMDL Calculations - Sample Point PERG01, mouth of Pergrin Run***

The TMDL for sample point PERG01 consists of three waste load allocations and a load allocation to all of the area above the point (Attachment A). The load allocation for this tributary was computed using water-quality sample data collected at point PERG01. The average flow of 2.15 MGD, measured at the point, is used for these computations.

This segment is not included on the PA Section 303(d) list. Sample data at point PERG01 shows pH ranging between 2.77 and 2.91; pH will be addressed as part of this TMDL.

<b>Table C23. TMDL Calculations at Point PERG01</b>				
<b>Flow = 2.15 MGD</b>	<b>Measured Sample Data</b>		<b>Allowable</b>	
<b>Parameter</b>	<b>Conc. (mg/l)</b>	<b>Load (lbs/day)</b>	<b>LTA Conc. (mg/l)</b>	<b>Load (lbs/day)</b>
Fe	69.56	864,642	0.49	6,052
Mn	3.57	44,416	0.36	4,442
Al	62.11	772,077	0.25	3,088
Acidity	603.28	7,499,231	0.00	0
Alkalinity	0.00	0.0		

<b>Table C24. Calculation of Load Reduction Necessary at Point PERG01</b>				
	Fe (lbs/day)	Mn (lbs/day)	Al (lbs/day)	Acidity (lbs/day)
Measured Load	864,642	44,416	772,077	7,499,231
Allowable Load	6,052	4,442	3,088	0
Allowable Load assigned to WLA	1	1	1	0
Allowable Load assigned to LA	6,051	4,441	3,087	0
Load Reduction	858,591	39,975	768,990	7,499,231
% Reduction require	99.3	90	99.6	100

Because the total segment WLAs are small in comparison to the allowable segment load, the total segment WLAs are rounded up to the next whole pound.

Also, because loadings from the discharges are not part of the current measured loads, it is necessary to calculate the load reduction based on the LA portion of the allowable load (Load Reduction = Measured Load – Allowable Load assigned to LA).

***TMDL Calculations - Sample Point BLCK03, South Branch downstream of Unnamed Tributary 44632***

The TMDL for sample point BLCK03 consists of a load allocation to all of the area between sample points BLCK03, PERG01 and BLCK04 shown in Attachment A. The TMDL for this stream segment was computed using water-quality sample data collected at point BLCK03. The average flow of 37.70 MGD, measured at the sampling point, is used for these computations.

This segment is not included on the PA Section 303(d) list. Sample data at point BLCK03 shows pH ranging between 3.31 and 6.25; pH will be addressed as part of this TMDL.

<b>Table C25. TMDL Calculations at Point BLCK03</b>				
Flow = 37.70 MGD	Measured Sample Data		Allowable	
Parameter	Conc. (mg/l)	Load (lbs/day)	LTA Conc. (mg/l)	Load (lbs/day)
Fe	5.28	1,153,388	0.26	57,669
Mn	0.60	130,017	0.27	58,508
Al	5.10	1,113,074	0.10	22,261
Acidity	41.59	9,080,844	1.25	272,425
Alkalinity	7.14	1,558,970		

The calculated load reductions for all the loads that enter point BLCK03 must be accounted for in the calculated reductions at the sample point shown in Table C26. A comparison of measured loads between points BLCK03, PERG01 and BLCK04 shows that there is additional loading entering the segment for iron, manganese, and aluminum and an insignificant loss of acidity

load. The total segment iron, manganese, and aluminum loads are the sum of the loads tracked from upstream points and the additional loading entering the segment.

<b>Table C26. Calculation of Load Reduction Necessary at Point BLCK03</b>				
	Fe (lbs/day)	Mn (lbs/day)	Al (lbs/day)	Acidity (lbs/day)
Measured Load	1,153,388	130,017	1,113,074	9,080,844
Difference in Measured Load	182,978	37,911	243,499	-3,434
Load tracked from upstream	101,131	35,633	37,213	649,869
Total Load tracked between points	284,109	73,545	280,711	649,869
Allowable Load at BLCK03	57,669	58,508	22,261	272,425
Load Reduction at BLCK03	226,440	15,037	258,450	377,444
% Reduction required at BLCK03	80	20	92	58

The upstream acidity load to the segment is greater than the allowable load at BLCK03. It is assumed to be a result of high data variability and that standards will be met at BLCK03 with the required upstream reductions.

### ***TMDL Calculations - Sample Point BLCK02, South Branch upstream of Coalpit Run***

The TMDL for sample point BLCK02 consists of a load allocation to all of the area between sample points BLCK02 and BLCK03 shown in Attachment A. The TMDL for this stream segment was computed using water-quality sample data collected at point BLCK02. The average flow of 39.50 MGD, measured at the sampling point, is used for these computations.

This section of stream contains two segments on the PA Section 303(d) list. From point BLCK03 to the mouth Unnamed Tributary 44630 was listed in 1996 for metals impairments from AMD. From the mouth of Unnamed Tributary 44630 to the mouth of Coalpit Run was listed in 2002 for metals and pH impairments from AMD. Sample data at point BLCK02 shows pH ranging between 3.74 and 6.44; pH will be addressed as part of this TMDL.

<b>Table C27. TMDL Calculations at Point BLCK02</b>				
Flow = 39.50 MGD	Measured Sample Data		Allowable	
Parameter	Conc. (mg/l)	Load (lbs/day)	LTA Conc. (mg/l)	Load (lbs/day)
Fe	3.12	714,633	0.66	150,073
Mn	0.70	161,173	0.35	80,586
Al	5.24	1,198,102	0.16	35,943
Acidity	39.24	8,977,001	0.78	179,540
Alkalinity	4.73	1,081,213		



The calculated load reductions for all the loads that enter point BLCK02 must be accounted for in the calculated reductions at the sample point shown in Table C28. A comparison of measured loads between points BLCK02 and BLCK03 shows that there is additional loading entering the segment for manganese and aluminum and a loss of iron and acidity loading. The total segment manganese and aluminum load is the sum of the loads tracked from upstream points and the additional loading entering the segment. For loss of iron and acidity load, the percent of load lost within the segment is calculated and applied to the upstream loads to determine the amount of the upstream load that is tracked through the segment.

The upstream acidity load to the segment is greater than the allowable load at BLCK02. It is assumed to be a result of data variability and that standards will be met at BLCK02 with the required upstream reductions.

<b>Table C28. Calculation of Load Reduction Necessary at Point BLCK02</b>				
	Fe (lbs/day)	Mn (lbs/day)	Al (lbs/day)	Acidity (lbs/day)
Measured Load	714,633	16,1173	1,198,102	8,977,001
Difference in Measured Load	-438,755	31,156	85,029	-103,842
Load tracked from upstream	57,669	58,508	22,261	272,425
% Load lost	38	-	-	1
% Load tracked	62	-	-	99
Total Load tracked between points	35,732	89,664	107,290	269,310
Allowable Load at BLCK02	150,073	80,586	35,943	179,540
Load Reduction at BLCK02	0	9,077	71,347	89,770
% Reduction required at BLCK02	0	10	66	33

### ***Waste Load Allocation – Discharge TP-A***

The waste load allocation for the Rosebud Mining Company site (discharge TPA) is calculated using measured average flow and average monthly permit limits. The waste load allocation for the mining operation is incorporated into the calculations at BLCK01. This is the first downstream monitoring point that receives all the potential flow of treated water from the site. The following table shows the waste load allocation for the discharge.

<b>Table C29. Waste Load Allocation Rosebud Mining Company site</b>				
Discharge	Parameter	Monthly Avg. Allowable Conc. (mg/L)	Average Flow (MGD)	WLA (lbs/day)
<i>Rosebud Mining Company, CMAP 11991301, NPDES PA0215210</i>				
TP-A	Fe	3.0	0.105	2.6
	Mn	2.0	0.105	1.8
	Al	2.0	0.105	1.8

***TMDL Calculations - Sample Point COAL01, mouth of Coalpit Run***

The TMDL for sample point COAL01 consists of a load allocation to all of the area above the point (Attachment A). The load allocation for this tributary was computed using water-quality sample data collected at point COAL01. The average flow of 3.02 MGD, measured at the point, is used for these computations.

This segment is not included on the PA Section 303(d) list. Sample data at point COAL01 shows pH ranging between 3.91 and 4.65; pH will be addressed as part of this TMDL.

<b>Table C30. TMDL Calculations at Point COAL01</b>				
Flow = 3.02 MGD	Measured Sample Data		Allowable	
Parameter	Conc. (mg/l)	Load (lbs/day)	LTA Conc. (mg/l)	Load (lbs/day)
Fe	0.80	13,927	0.57	10,027
Mn	1.01	17,653	0.43	7,591
Al	4.21	73,648	0.42	7,365
Acidity	42.61	745,668	0.00	0
Alkalinity	0.22	3,859		

<b>Table C31. Calculation of Load Reduction Necessary at Point COAL01</b>				
	Fe (lbs/day)	Mn (lbs/day)	Al (lbs/day)	Acidity (lbs/day)
Measured Load	13,927	17,653	73,648	745,668
Allowable Load	10,027	7,591	7,365	0
Load Reduction	3,900	10,062	66,283	745,668
Total % Reduction	28	57	90	100

***TMDL Calculations - Sample Point BRAK01, mouth of Bracken Run***

The TMDL for sample point BRAK01 consists of a load allocation to all of the area above the point (Attachment A). The load allocation for this tributary was computed using water-quality sample data collected at point BRAK01. The average flow of 1.00 MGD, measured at the point, is used for these computations.

This segment is not included on the PA Section 303(d) list. Sample data at point BRAK01 shows pH ranging between 4.19 and 4.64; pH will be addressed as part of this TMDL.

The simulation determined that the measured iron load is equal to the allowable load. Because the WQS is met, a TMDL for iron is not necessary. Although a TMDL is not necessary, the loading is considered at the next downstream point, BLCK01.

<b>Table C32. TMDL Calculations at Point BRAK01</b>				
Flow = 1.00 MGD	Measured Sample Data		Allowable	
Parameter	Conc. (mg/l)	Load (lbs/day)	LTA Conc. (mg/l)	Load (lbs/day)
Fe	0.15	886	0.15	886
Mn	1.67	9,654	0.45	2,607
Al	2.05	11,846	0.49	2,843
Acidity	26.18	151,462	0.00	0
Alkalinity	0.092	534		

<b>Table C33. Calculation of Load Reduction Necessary at Point BRAK01</b>				
	Fe (lbs/day)	Mn (lbs/day)	Al (lbs/day)	Acidity (lbs/day)
Measured Load	886	9,654	11,846	151,462
Allowable Load	886	2,607	2,843	0
Load Reduction	0	7,047	9,003	151,462
Total % Reduction	0	73	76	100

***TMDL Calculations - Sample Point BLCK01, mouth of South Branch Blacklick Creek***

The TMDL for sample point BLCK01 consists of a waste load allocation to the Rosebud Mining Company TP-A discharge and a load allocation to all of the area between sample points BLCK01, BLCK02, BRAK01, and COAL01 shown in Attachment A. The TMDL for this stream segment was computed using water-quality sample data collected at point BLCK01. The average flow of 52.69 MGD, measured at the sampling point, is used for these computations.

This segment is not on the PA Section 303(d) list. Sample data at point BLCK01 shows pH ranging between 3.80 and 5.95; pH will be addressed as part of this TMDL.

<b>Table C34. TMDL Calculations at Point BLCK01</b>				
Flow = 52.69 MGD	Measured Sample Data		Allowable	
Parameter	Conc. (mg/l)	Load (lbs/day)	LTA Conc. (mg/l)	Load (lbs/day)
Fe	3.01	919,834	0.87	266,752
Mn	0.79	241,207	0.36	108,543
Al	4.71	1,437,779	0.24	71,889
Acidity	44.53	13,586,568	0.00	0
Alkalinity	1.22	370,857		

The calculated load reductions for all the loads that enter point BLCK01 must be accounted for in the calculated reductions at the sample point shown in Table C35. A comparison of measured

loads between points BLCK01, BLCK02, BRAK01, and COAL01 shows that there is additional loading entering the segment for all parameters. The total segment load is the sum of the loads tracked from upstream points and the additional loading entering the segment.

**Table C35. Calculation of Load Reduction Necessary at Point BLCK01**

	Fe (lbs/day)	Mn (lbs/day)	Al (lbs/day)	Acidity (lbs/day)
Measured Load	919,834	241,207	1,437,779	13,586,568
Difference in Measured Load	190,388	52,727	154,183	3,712,438
Load tracked upstream	46,645	90,784	46,151	179,540
Total Load tracked between points	237,033	143,511	200,334	3,891,978
Allowable Load at BLCK01	266,752	108,543	71,889	0
Allowable Load assigned to WLA	3	2	2	0
Allowable Load assigned to LA	266,749	108,541	71,887	0
Load Reduction at BLCK01	0	34,968	128,445	3,891,978
% Reduction required at BLCK01	0	24	64	100

Because the total segment WLAs are small in comparison to the allowable segment load, the total segment WLAs are rounded up to the next whole pound.

### *Margin of Safety*

For this study the margin of safety is applied implicitly. A MOS is implicit because the allowable concentrations and loadings were simulated using Monte Carlo techniques and employing the @Risk software. Other margins of safety used for this TMDL analysis include the following:

- Effluent variability plays a major role in determining the average value that will meet water-quality criteria over the long-term. The value that provides this variability in our analysis is the standard deviation of the dataset. The simulation results are based on this variability and the existing stream conditions (an uncontrolled system). The general assumption can be made that a controlled system (one that is controlling and stabilizing the pollution load) would be less variable than an uncontrolled system. This implicitly builds in a margin of safety.
- An additional MOS is provided because the calculations were done with a daily Fe average instead of the 30-day average

### *Seasonal Variation*

Seasonal variation is implicitly accounted for in these TMDLs because the data used represents all seasons.

### *Critical Conditions*

The reductions specified in this TMDL apply at all flow conditions. A critical flow condition could not be identified from the data used for this analysis.

# **Attachment D**

## **Excerpts Justifying Changes Between the 1996, 1998, and 2002 Section 303(d) Lists**

*The following are excerpts from the Pennsylvania DEP Section 303(d) narratives that justify changes in listings between the 1996, 1998, and 2002 list. The Section 303(d) listing process has undergone an evolution in Pennsylvania since the development of the 1996 list.*

In the 1996 Section 303(d) narrative, strategies were outlined for changes to the listing process. Suggestions included, but were not limited to, a migration to a Global Information System (GIS), improved monitoring and assessment, and greater public input.

The migration to a GIS was implemented prior to the development of the 1998 Section 303(d) list. As a result of additional sampling and the migration to the GIS some of the information appearing on the 1996 list differed from the 1998 list. Most common changes included:

1. mileage differences due to recalculation of segment length by the GIS;
2. slight changes in source(s)/cause(s) due to new EPA codes;
3. changes to source(s)/cause(s), and/or miles due to revised assessments;
4. corrections of misnamed streams or streams placed in inappropriate SWP subbasins; and
5. unnamed tributaries no longer identified as such and placed under the named watershed listing.

Prior to 1998, segment lengths were computed using a map wheel and calculator. The segment lengths listed on the 1998 Section 303(d) list were calculated automatically by the GIS (ArcInfo) using a constant projection and map units (meters) for each watershed. Segment lengths originally calculated by using a map wheel and those calculated by the GIS did not always match closely. This was the case even when physical identifiers (e.g., tributary confluence and road crossings) matching the original segment descriptions were used to define segments on digital quad maps. This occurred to some extent with all segments, but was most noticeable in segments with the greatest potential for human errors using a map wheel for calculating the original segment lengths (e.g., long stream segments or entire basins).

# **Attachment E**

## **Water Quality Data Used In TMDL Calculations**



<b>BLCK01</b>	<b>Date</b>	<b>Flow (gpm)</b>	<b>pH</b>	<b>Acidity (mg/L)</b>	<b>Alk (mg/L)</b>	<b>Al (mg/L)</b>	<b>Fe (mg/L)</b>	<b>Mn (mg/L)</b>
	2/16/2002	34988	4.66	30	1.0	3.3	2.5	0.59
Latitude:	3/29/2002	92488	4.36	28	0	3.3	2.5	0.32
N40°48.303'	4/19/2002	57847	4.49	29	0	2.7	2.4	0.54
Longitude:	7/1/2002	12668	4.11	79	0	6.6	4.4	1.03
W78°92.296'	8/1/2002	3049	3.80	92	0	9.6	3.0	1.50
	10/18/2002	18482	5.95	8.9	6.3	2.7	3.3	0.76
	Average	36587.00000	4.56167	44.52633	1.21538	4.71194	3.01451	0.79049
	St Dev	33478.86865	0.74392	32.74043	2.53862	2.81122	0.73341	0.42092

<b>BRAK01</b>	<b>Date</b>	<b>Flow (gpm)</b>	<b>pH</b>	<b>Acidity (mg/L)</b>	<b>Alk (mg/L)</b>	<b>Al (mg/L)</b>	<b>Fe (mg/L)</b>	<b>Mn (mg/L)</b>
	2/16/2002	728	4.28	26	0.0	2.2	0.11	1.20
Latitude:	3/29/2002	2193	4.19	25	0	2.5	0.32	0.96
N40°47.866'	4/19/2002	912	4.24	26	0	2.1	0.21	1.30
Longitude:	7/1/2002	135	4.64	28	0	1.9	0.09	1.76
W78°90.602'	8/1/2002	61	4.49	28	0	1.4	0.10	2.10
	10/18/2002	133	4.58	24	0.6	2.13	0.09	2.69
	Average	693.60000	4.40333	26.18347	0.09231	2.04777	0.15313	1.66886
	St Dev	815.36220	0.19086	1.43738	0.22611	0.36263	0.09209	0.64692

<b>COAL01</b>	<b>Date</b>	<b>Flow (gpm)</b>	<b>pH</b>	<b>Acidity (mg/L)</b>	<b>Alk (mg/L)</b>	<b>Al (mg/L)</b>	<b>Fe (mg/L)</b>	<b>Mn (mg/L)</b>
	2/16/2002	1827	3.95	40	0	4.6	1.01	0.78
Latitude:	3/29/2002	5954	3.91	33	0	3.7	1.23	0.45
N40°49.613'	4/19/2002	3773	4.09	39	0	3.5	1.10	0.76
Longitude:	7/1/2002	501	4.13	62	0	5.6	0.74	1.25
W78°86.671'	8/1/2002	139	4.53	42	0	5.1	0.42	1.60
	10/18/2002	397	4.65	40	1.3	2.81	0.27	1.21
	Average	2098.50000	4.21000	42.60598	0.22051	4.20808	0.79576	1.00868
	St Dev	2325.05017	0.30803	9.85017	0.54014	1.05090	0.38765	0.41730

<b>BLCK02</b>	<b>Date</b>	<b>Flow (gpm)</b>	<b>pH</b>	<b>Acidity (mg/L)</b>	<b>Alk (mg/L)</b>	<b>Al (mg/L)</b>	<b>Fe (mg/L)</b>	<b>Mn (mg/L)</b>
	2/16/2002	25248	4.77	23	1.3	3.0	2.5	0.47
Latitude:	3/29/2002	66983	4.56	25	8.8	2.9	2.0	0.47
N40°49.547'	4/19/2002	44782	4.55	24	1.1	2.7	2.2	0.47
Longitude:	7/1/2002	11719	4.27	69	0.0	6.7	5.1	0.87
W78°86.738'	8/1/2002	2767	3.74	94	0.0	14	4.1	1.40
	10/18/2002	13087	6.44	1.3	17.1	2.16	2.82	0.54
	Average	27431.00000	4.72167	39.23951	4.72611	5.23704	3.12374	0.70450
	St Dev	24212.03655	0.91414	34.63360	6.90524	4.58486	1.21553	0.37413

<b>BLCK03</b>	<b>Date</b>	<b>Flow (gpm)</b>	<b>pH</b>	<b>Acidity (mg/L)</b>	<b>Alk (mg/L)</b>	<b>Al (mg/L)</b>	<b>Fe (mg/L)</b>	<b>Mn (mg/L)</b>
	2/15/2002	22699	6.25	3.3	8.2	1.2	1.13	0.30
Latitude:	3/29/2002	63390	4.98	14	8.5	2.0	1.74	0.31
N40°47.131'	4/19/2002	43215	5.37	14	4.4	1.6	1.50	0.27
Longitude:	7/1/2002	11051	4.13	68	0.0	6.7	7.48	0.80
W78°83.599'	8/1/2002	2202	3.31	132	0.0	17	17	1.40
	10/18/2002	14536	6.19	18.2	21.8	2.1	2.84	0.49
	Average	26182.16667	5.03833	41.58671	7.13947	5.09744	5.28207	0.59543
	St Dev	22918.57988	1.15932	49.89597	8.08262	6.16779	6.19959	0.44123

<b>PERG01</b>	<b>Date</b>	<b>Flow (gpm)</b>	<b>pH</b>	<b>Acidity (mg/L)</b>	<b>Alk (mg/L)</b>	<b>Al (mg/L)</b>	<b>Fe (mg/L)</b>	<b>Mn (mg/L)</b>
	2/15/2002	1516	2.90	394	0	38	39	2.2
Latitude:	3/29/2002	3617	2.87	296	0	28	29	1.7
N40°46.805'	4/19/2002	2316	2.91	365	0	37	36	3.0
Longitude:	7/1/2002	879	2.86	798	0	76	85	5.6
W78°83.468'	8/1/2002	337	2.77	799	0	91	108	5.9
	10/18/2002	278	2.80	967	0	102	120	3.0
	Average	1490.50000	2.85167	603.27967	0.00000	62.11018	69.55663	3.57306
	St Dev	1294.50790	0.05565	284.18200	0.00000	31.48710	39.84001	1.76335

<b>BLCK04</b>	<b>Date</b>	<b>Flow (gpm)</b>	<b>pH</b>	<b>Acidity (mg/L)</b>	<b>Alk (mg/L)</b>	<b>Al (mg/L)</b>	<b>Fe (mg/L)</b>	<b>Mn (mg/L)</b>
	2/15/2002	22658	6.54	2.9	8.3	0.74	0.45	0.25
Latitude:	3/29/2002	53874	6.19	4.5	6.2	1.21	0.79	0.23
N40°46.045'	4/19/2002	34575	6.06	0.9	10.4	0.62	0.53	0.20
Longitude:	7/1/2002	9696	5.81	2.3	22.4	0.23	0.60	0.31
W78°82.617'	8/1/2002	1376	7.12	22.4	30.3	0.09	0.43	0.23
	10/18/2002	13566	6.79	17.4	31.9	0.21	0.57	0.29
	Average	22624.16667	6.41833	8.40047	18.26449	0.51672	0.56055	0.25275
	St Dev	19079.03619	0.48906	9.12102	11.43706	0.42380	0.12853	0.04075

<b>BLCK05</b>	<b>Date</b>	<b>Flow (gpm)</b>	<b>pH</b>	<b>Acidity (mg/L)</b>	<b>Alk (mg/L)</b>	<b>Al (mg/L)</b>	<b>Fe (mg/L)</b>	<b>Mn (mg/L)</b>
	2/15/2002	18958	6.71	2.8	12.5	0.34	0.22	0.14
Latitude:	3/29/2002	52100	6.77	7.9	9.2	0.37	0.32	0.12
N40°45.966'	4/19/2002	33349	6.27	1.3	11.8	0.24	0.24	0.11
Longitude:	7/1/2002	4863	6.00	16.6	19.1	0.02	0.24	0.15
W78°82.446'	8/1/2002	1340	7.26	16	31.4	0.02	0.56	0.13
	10/18/2002	10528	6.74	16	29.1	0.03	0.34	0.21
	Average	20189.66667	6.62500	10.17677	18.82786	0.16951	0.31983	0.14381
	St Dev	19372.75859	0.43849	7.12927	9.43145	0.16562	0.12662	0.03542

<b>STEW01</b>	<b>Date</b>	<b>Flow (gpm)</b>	<b>pH</b>	<b>Acidity (mg/L)</b>	<b>Alk (mg/L)</b>	<b>Al (mg/L)</b>	<b>Fe (mg/L)</b>	<b>Mn (mg/L)</b>
	2/15/2002	4083	6.95	12.0	15.2	0.04	0.07	0.04
Latitude:	3/29/2002	10578	6.72	11.0	11.1	0.15	0.21	0.04
N40°45.822'	4/19/2002	8159	6.27	10.0	14.3	0.08	0.16	0.02
Longitude:	7/1/2002	1274	6.16	15	32.7	0.04	0.15	0.02
W78°82.226'	8/1/2002	153	7.89	13	49.4	0.02	0.26	0.03
	10/18/2002	1909	6.78	14	30.6	0.02	0.50	0.02
	Average	4359.33333	6.79500	12.45000	25.55930	0.05860	0.22427	0.02989
	St Dev	4156.97720	0.61770	1.76607	14.75914	0.05169	0.14896	0.01208

<b>BLCK06</b>	<b>Date</b>	<b>Flow (gpm)</b>	<b>pH</b>	<b>Acidity (mg/L)</b>	<b>Alk (mg/L)</b>	<b>Al (mg/L)</b>	<b>Fe (mg/L)</b>	<b>Mn (mg/L)</b>
	2/15/2002	12006	6.48	1.8	9.9	0.92	0.29	0.19
Latitude:	3/29/2002	30172	6.60	3.4	6.8	0.79	0.31	0.16
N40°47.420'	4/19/2002	20269	6.11	1.4	9.3	0.51	0.44	0.19
Longitude:	7/1/2002	2238	5.56	16	3.4	1.12	0.22	0.45
W78°77.872'	8/1/2002	491	6.84	3.9	7.1	1.00	0.21	0.94
	10/18/2002	5649	6.86	22.1	31.3	0.36	0.50	0.26
	Average	11804.16667	6.40833	8.06360	11.29277	0.78412	0.32724	0.36542
	St Dev	11545.18777	0.49817	8.70182	10.07606	0.29428	0.11825	0.30046

<b>BLCK07</b>	<b>Date</b>	<b>Flow (gpm)</b>	<b>pH</b>	<b>Acidity (mg/L)</b>	<b>Alk (mg/L)</b>	<b>Al (mg/L)</b>	<b>Fe (mg/L)</b>	<b>Mn (mg/L)</b>
	2/15/2002	12017	6.47	2.5	8.3	1.09	0.31	0.22
Latitude:	3/29/2002	28360	6.63	1.8	8.2	0.93	0.30	0.16
N40°47.604'	4/19/2002	21381	6.07	1.6	8.7	0.56	0.35	0.19
Longitude:	7/1/2002	2947	5.38	17	4.2	1.48	0.26	0.48
W78°77.553'	8/1/2002	440	6.39	9.9	6.6	1.10	0.34	0.98
	10/18/2002	5215	6.82	4.8	31.4	0.60	0.32	0.31
	Average	11726.66667	6.29333	6.31125	11.21782	0.95942	0.31375	0.38897
	St Dev	11107.03756	0.51290	6.16783	10.02856	0.34572	0.03216	0.31207

<b>WILL01</b>	<b>Date</b>	<b>Flow (gpm)</b>	<b>pH</b>	<b>Acidity (mg/L)</b>	<b>Alk (mg/L)</b>	<b>Al (mg/L)</b>	<b>Fe (mg/L)</b>	<b>Mn (mg/L)</b>
	2/15/2002	5972	6.52	0.00	7.0	0.06	0.31	0.06
Latitude:	3/29/2002	15114	6.64	1.9	5.7	0.14	0.30	0.07
N40°48.172'	4/19/2002	10232	6.02	2.2	7.0	0.19	0.35	0.04
Longitude:	7/1/2002	1091	5.71	14.4	12.5	0.06	0.26	0.02
W78°77.220'	8/1/2002	224	7.15	11.0	18.5	0.02	0.34	0.04
	10/18/2002	728	6.34	2.4	11.2	0.06	0.32	0.07
	Average	5560.16667	6.39667	5.29767	10.31492	0.08883	0.31375	0.05050
	St Dev	6083.90212	0.50170	5.87886	4.80575	0.06373	0.03216	0.02039

<b>BLCK08</b>	<b>Date</b>	<b>Flow (gpm)</b>	<b>pH</b>	<b>Acidity (mg/L)</b>	<b>Alk (mg/L)</b>	<b>Al (mg/L)</b>	<b>Fe (mg/L)</b>	<b>Mn (mg/L)</b>
	2/15/2002	4311	5.56	10.6	3.9	2.5	0.55	0.38
Latitude:	3/29/2002	12783	5.64	7.7	6.5	2.1	0.66	0.32
N40°48.664'	4/19/2002	8104	5.85	6.2	7.2	3.0	1.70	0.40
Longitude:	7/1/2002	821	4.48	83	0.0	13	1.62	1.40
W78°76.266'	8/1/2002	259	4.35	117	0.0	21	1.40	2.3
	10/18/2002	2531	6.20	18.4	22.9	2.8	0.87	0.54
	Average	4801.50000	5.34667	40.38908	6.74884	7.41525	1.13365	0.88904
	St Dev	4826.70272	0.75598	47.36115	8.49769	7.84868	0.50219	0.80027

<b>BLUT01</b>	<b>Date</b>	<b>Flow (gpm)</b>	<b>pH</b>	<b>Acidity (mg/L)</b>	<b>Alk (mg/L)</b>	<b>A I (mg/L)</b>	<b>Fe (mg/L)</b>	<b>Mn (mg/L)</b>
	2/16/2002	35	5.46	8.4	2.2	0.68	0.06	0.27
Latitude:	3/29/2002	591	5.75	7.2	3.0	0.97	0.12	0.31
N40°49.334'	4/19/2002	254	5.92	6.5	4.8	0.62	0.18	0.26
Longitude:	7/1/2002	46	5.60	9.9	5.9	0.30	0.18	0.23
W78°75.980'	8/1/2002	0						
	10/18/2002	140	6.46	1.3	25.5	0.28	0.16	0.14
	Average	177.66667	5.83800	6.65606	8.26769	0.56910	0.13907	0.24225
	St Dev	222.41643	0.38758	3.25931	9.76330	0.28636	0.05149	0.06413

<b>BLCK09</b>	<b>Date</b>	<b>Flow (gpm)</b>	<b>pH</b>	<b>Acidity (mg/L)</b>	<b>Alk (mg/L)</b>	<b>Al (mg/L)</b>	<b>Fe (mg/L)</b>	<b>Mn (mg/L)</b>
	2/16/2002	2699	6.40	0.0	14.0	0.05	0.29	0.14
Latitude:	3/29/2002	9617	6.56	7.9	11.2	0.05	0.23	0.10
N40°49.132'	4/19/2002	5673	6.82	14.4	16.6	0.24	0.66	0.12
Longitude:	7/1/2002	257	6.09	24.8	34.3	0.15	1.51	0.31
W78°75.250'	8/1/2002	121	6.98	21	48.3	0.44	2.2	0.78
	10/18/2002	1298	6.48	20	29.8	0.24	0.80	0.18
	Average	3277.50000	6.55500	14.70000	25.69736	0.19488	0.94900	0.27125
	St Dev	3722.03373	0.31520	9.31665	14.38177	0.14721	0.76563	0.26036

<b>CMAP 11991301</b>	
<b>NPDES PA0215210</b>	
TP-A	
Latitude:	Longitude:
40 29' 34"	78 52' 47"
Date	Flow
	MGD
Apr-02	0.1022
May-02	0.1980
Jun-02	0.1108
Jul-02	0.0734
Aug-02	0.0489
Sep-02	0.0352
Oct-02	0.0828
Nov-02	0.1116
Dec-02	0.1094
Jan-03	0.1116
Feb-03	0.1670
Mar-03	0.1123
Average	0.1053
St Dev	0.04493

<b>CMAP 11841301</b>	
<b>NPDES PA0001317</b>	
001a	
Latitude:	Longitude:
40 28' 30"	78 46' 35"
Date	Flow
	MGD
Apr-02	0.0000
May-02	0.0000
Jun-02	0.0000
Jul-02	0.0000
Aug-02	0.0000
Sep-02	0.6540
Oct-02	1.6990
Nov-02	2.9770
Dec-02	1.6020
Jan-03	0.0000
Feb-03	0.0000
Mar-03	0.0000
Average	0.5777
St Dev	0.9881

<b>CMAP 1170301</b>	
<b>NPDES PA0001333</b>	
001b	
Latitude:	Longitude:
40 27' 15"	78 49' 40"
Date	Flow
	MGD
Apr-02	0
May-02	2.598
Jun-02	3.651
Jul-02	3.953
Aug-02	1.653
Sep-02	1.862
Oct-02	3.927
Nov-02	1.633
Dec-02	2.11
Jan-03	4.288
Feb-03	4.714
Mar-03	2.482
Average	2.7393
St Dev	1.3874

<b>SMP 11960202</b>	
<b>NPDES PA0234311</b>	
<b>30</b>	
Latitude:	Longitude:
40 29' 26"	78 45' 14"
Date	Flow (gpm)
12/18/1997	12
1/19/1998	4.24
2/23/1998	3.53
3/26/1998	0
4/29/1998	0
5/28/1998	0
6/16/1998	0
7/24/1998	0
8/31/1998	0
9/21/1998	0
10/21/1998	0
11/18/1998	0
12/16/1998	0
1/13/1999	0
2/10/1999	0
3/17/1999	0
4/14/1999	0
5/26/1999	0
6/22/1999	0
7/14/1999	0
8/11/1999	0
9/22/1999	0
10/27/1999	0
11/17/1999	0

12/15/1999	0
1/27/2000	0
2/16/2000	0
3/15/2000	0
4/19/2000	0
5/17/2000	0
6/14/2000	0
9/29/2000	0
12/13/2000	0
3/14/2001	0
6/11/2001	0
9/13/2001	0
11/6/2001	0
3/8/2002	0
4/16/2002	0
9/3/2002	0
11/6/2003	0
3/7/2003	0
Average	0.471
St Dev	2.007

# **Attachment F**

## **Comment and Response**

## **Comments/Responses on the South Branch Blacklick Creek Watershed TMDL**

A 60-day public comment period was open on the South Branch Blacklick Creek Watershed Draft TMDL from November 6, 2004 until January 5, 2005. During this time, no comments were received.