



# WESTMORELAND COUNTY'S Integrated Water Resources Plan



*For more information contact:*



218 Donohoe Road • Greensburg, PA 15601 • 724-837-5271  
[www.westmorelandstormwater.org](http://www.westmorelandstormwater.org) email: [waterplan@wcdpa.com](mailto:waterplan@wcdpa.com)

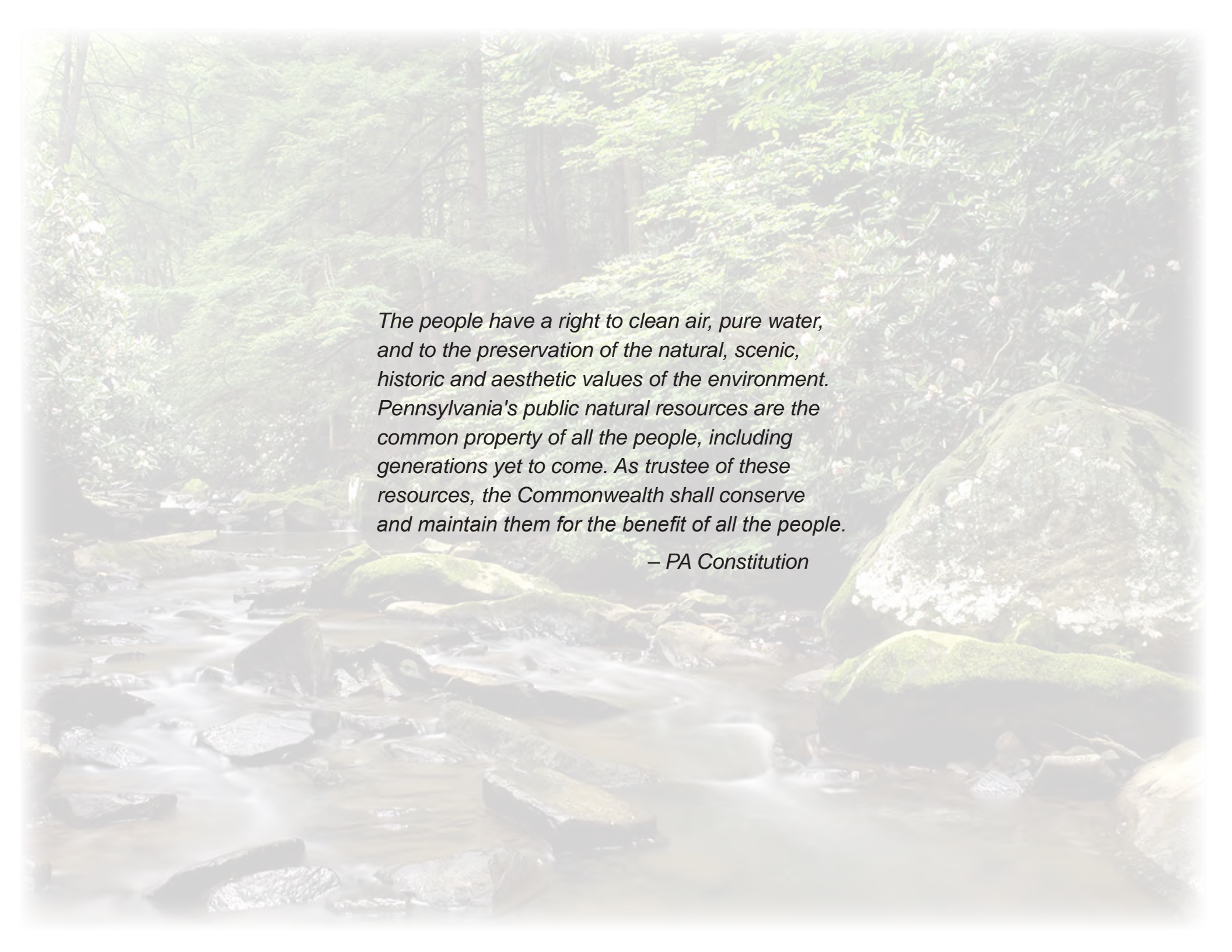

A scenic view of a forest stream flowing over mossy rocks, surrounded by dense green foliage. The water is clear and flows over several large, flat rocks covered in bright green moss. The background is a thick forest of tall trees with vibrant green leaves, suggesting a healthy, natural environment.

*The people have a right to clean air, pure water,  
and to the preservation of the natural, scenic,  
historic and aesthetic values of the environment.  
Pennsylvania's public natural resources are the  
common property of all the people, including  
generations yet to come. As trustee of these  
resources, the Commonwealth shall conserve  
and maintain them for the benefit of all the people.*

*– PA Constitution*



*Water is so everywhere present, and such a commonplace, that its gifts seem almost limitless.*

*– Stephanie Mills*

September 2018

Water is one of our most precious natural commodities. And our relationship to it is far-reaching and complex.

We use it to fuel our industries, including Westmoreland County's number one industry, agriculture.

We use it as a place to have fun in our bathing suits and on boats.

We use it to provide food and to carry away our sewage.

And, of course, we use it as the most fundamental of all liquids for nourishing our bodies.

Our dependence on water for so many aspects of our daily lives emphatically drives home the need for its careful stewardship.

In 2015, the Westmoreland Conservation District began a community partnership effort that looked deeply into the ways we use water throughout Westmoreland County...the impacts of those uses...and some of the things that can be done to ensure that this important resource is responsibly managed.

The result is this document – Westmoreland County's first-ever Integrated Water Resources Plan, a guide for good stewardship of our water resources.

The IWRP completes the Act 167 Plan Phase 2, and coincides with Westmoreland County's 2018 comprehensive plan, "Reimagining Our Westmoreland".

Like flowing water, the IWRP is not a static document, but one that will be updated in its online presence ([www.westmorelandstormwater.org](http://www.westmorelandstormwater.org)) as new data becomes available.

We are grateful for the many partners that have contributed their support, expertise, and insights to this important work, including the Westmoreland County Commissioners, the Westmoreland County Department of Planning and Development, the volunteer members of the Watershed Plan Advisory Committee, Ethos Collaborative LLC, and the Richard King Mellon Foundation.

Ronald J. Rohall  
Chairman

Gregory M. Phillips  
District Manager/CEO



Photo by Mark Jackson

*(l-r) Westmoreland Conservation District Manager/CEO Greg Phillips talks with District Board Chairman Ron Rohall on the rocky banks of Linn Run, Linn Run State Park, Rector, PA.*





# WESTMORELAND COUNTY'S Integrated Water Resources Plan

## TABLE OF CONTENTS

### LETTER from our Chairman & CEO

– Ron Rohall, Greg Phillips

### PREFACE

### EXECUTIVE SUMMARY

### Chapter 1. INTRODUCTION

- Westmoreland Conservation District
- Sustainability
- Goals
- Scope of Work
- Watershed Plan Advisory Committee
- Funding

### Chapter 2. WESTMORELAND COUNTY

- History
- Ohio River Basin
- Natural Features
- Population and Political Boundaries
- Land Use
- County Comprehensive Plan

### Chapter 3. WATER RESOURCES

- Natural Water Cycle
- Water Resources
- Regulations

### Chapter 4. IMPACTS

- County Comprehensive Plan
- Phase 1 Act 167 Plan
- Water Use
- Stormwater Management
- Impairments / Pollutants
- Climate Change

### Chapter 5. ISSUES AND CHALLENGES

- Watershed and Pollutant Modeling
  - Turtle Creek
  - Sewickley Creek
  - Kiskiminetas River
  - Conemaugh River
  - Loyalhanna Creek
  - Monongahela River
  - Pucketa, Plum, Allegheny River
  - Jacobs Creek
  - Youghioghny River
  - Indian Creek
- Conceptual Projects and Costs

### Chapter 6. IWRP ACTION PLAN

- Initiatives
  - Federal
  - Interstate
  - State
  - Regional
  - Local initiatives
- Implementation Strategies

### Appendix

- Act 167 Plan Requirements
- Model Stormwater Ordinance
- Decision Making Flowchart
- Resource Library
- Watershed Plans
- Water and Sewer Authorities
- BMP Portfolio and Maintenance Guidelines
- Homeowners Guide to Stormwater Management/Toolkit
- Watershed and Pollutant Modeling Methodolgy





Photo by Mark Jackson

*Linn Run, Linn Run State Park, Rector, PA*

## PREFACE

In 2015, work began to create an Integrated Water Resources Plan (IWRP) for Westmoreland County to address all water resources within the county, study water issues, impacts, and solutions across the county's watersheds, and fulfill the requirements of the Pennsylvania Stormwater Management Act 167. The Westmoreland Conservation District (District), partnering with the Westmoreland County Department of Planning and Development, with the approval of the Westmoreland County Commissioners, and funding from the Richard King Mellon Foundation, undertook the process.

The Westmoreland County IWRP is easily accessible online and includes an overview of the county and our water resources, a description of land use impacts on our water resources, the issues and challenges we face, and an action plan to sustain our water resources into the future. The IWRP includes a decision making flowchart for all people making decisions about land development that impact our county's water resources, a model stormwater ordinance for adoption

by all municipalities, and an explanation of the watershed modeling process and results that establishes stormwater runoff release rates for new and redevelopment.

The county commissioners signed a resolution to commence the IWRP in December 2015. The following year saw the creation of the Watershed Plan Advisory Committee (WPAC) led by the District to guide the development of the plan. An engineering consultant, Ethos Collaborative LLC, was hired to model 10 priority watershed areas of interest within the county identified in Phase 1 of the County's Act 167 Plan completed by L. Robert Kimball and Associates in 2010. As the IWRP progressed, the District, our partners, and the WPAC, completed the inventory, analysis, and creation of the plan, the watershed modeling, development of the model stormwater ordinance, and the online decision making tool for anyone seeking to develop land within the county related to our water resources. The Westmoreland County IWRP will be adopted by the County and will be updated as needed to meet future needs to sustain our water resources.



## EXECUTIVE SUMMARY

Westmoreland County is home to more than 350,000 residents living in 65 communities, spread across 1,025 square miles. This population interacts with water in many ways: drinking water, generating waste water, using water in industries, causing stormwater runoff, enjoying water-based recreation, and protecting our natural water resources. The need for clean and sustainable water resources is pressing. Household consumption of water reaches 65 gallons per day per person. Because of this great number, 41 sewage treatment plants and 10 water providing authorities are present in Westmoreland County. Historical increases in land development and related stormwater runoff have created a variety of challenges to the sustainability of our water resources.

Westmoreland County has 2,037 miles of streams and is home to abundant water resources including wetlands, groundwater, streams, lakes, and floodplains. All these **water resources** are linked together as part of the natural water cycle. However, the water cycle is affected by land development and changes in land use. Excess stormwater runoff is one of the key natural resource issues in our county contributing to flooding, erosion, pollution, and property damage. Uncontrolled stormwater can flood homes, roads, and businesses. Flood control facilities, channels, dams, and debris basins have been built to reduce flooding, but the top three storm water issues in the county still include flooding, inadequate infrastructure, and water pollution. From 2014 to 2017, a total of 836 complaints regarding stormwater issues were received by the Westmoreland Conservation District (District).

Stormwater runoff is only one of the **impacts** on our waterways. Fourteen percent of our 2,037 miles of waterways are affected by abandoned mine drainage (AMD). AMD contributes an influx of toxic chemicals such as iron, aluminum, and sulfur into these streams. Industry, agriculture, and resource operations such as natural gas extraction require large amounts of water. They can also create pollution that can contaminate or degrade water resources. Stormwater runoff from these activities can carry oil, metals, and sediment to our waterways. These pollutants have the potential to contaminate drinking water and harm aquatic life.

To respond to these concerns, the District and the Westmoreland County Department of Planning and Development developed the Integrated Water Resources Plan (IWRP). The IWRP studies water **issues and challenges** across the county's watersheds, while fulfilling the requirements of the Pennsylvania Storm Water Management Act 167. The IWRP provides a guide for future development and

redevelopment to reduce future impacts to water resources and even correct past impacts from unmanaged development. **The four goals of the IWRP are to advance sustainable water resources, encourage partnerships, provide accessible information and help meet regulatory mandates for water resources.**

The IWRP takes an in-depth look at the ten priority watersheds/areas of interest (AOI), identified in the Act 167 Phase 1 report. The AOIs studied include: Turtle Creek, Sewickley Creek, Kiskiminetas River, Conemaugh River, Loyalhanna Creek, Monongahela River, Allegheny River – Pucketa Creek – Plum Creek, Jacobs Creek, Youghiogheny River and Indian Creek. The watersheds in the county that were not studied in detail were still included in the data gathering and are summarized as well. Suggestions are made on projects to abate stormwater issues such as stream restoration, stormwater management retrofits, mechanical pollutant capture, land acquisition in flood hazard areas, AMD treatment, and green infrastructure. Techniques are presented to meet varying existing site conditions and to solve the wide-ranging stormwater issues.

**Initiatives** at every governmental level work to sustain our water resources. Federal agencies including the Environmental Protection Agency (EPA) regulate water and provide grants and funds for projects. State initiatives including PA DEP's Growing Greener Program help keep our resources safe. At the local level, the District monitors new and redevelopment and educates the public and professional audiences about water resources, and engages county agencies, authorities, and municipalities in cooperative programs.

Moving towards sustainable water resources, the IWRP has developed a list of **implementation strategies** to meet the four goals set above. By prioritizing the strategies and identifying a responsible party, Westmoreland County can achieve better stewardship of our water resources.

To help residents, professionals, and others understand the IWRP and implement it, the set of **appendices** included with the IWRP contain Phase 2 Act 167 Plan requirements, a model stormwater management ordinance, the decision-making flowchart and instructions, our Best Management Practice Portfolio and maintenance guidelines, the Homeowners Guide to Stormwater Management/Toolkit, Resource Library, links to current watershed plans, water and sewer information and list of local authorities serving the county, and the watershed and pollutant modeling methodology.

## Chapter 1. **INTRODUCTION**

Westmoreland County is home to more than 350,000 people in 65 communities spread across 1,025 square miles of rolling hills and wooded ridges dotted with farms, homes, businesses, and recreational opportunities. Westmoreland County is a microcosm of Pennsylvania—from its natural features to its population and its land use—the county is a collection of productive rural farms, developed urban areas, beautiful natural features, diverse forestland, steep hills, rich soils, rebuilt industrial areas, new and older residential areas, fishable water bodies, and busy waterways and highways. Like much of Pennsylvania, we are ‘water-rich’ but in need of careful management. Water resources are important in the lives and livelihoods of all residents and visitors to the county and should be protected for future generations.

This Integrated Water Resources Plan (IWRP) will help protect and sustain our water resources and meet the requirements of the PA Stormwater Management Act 167.

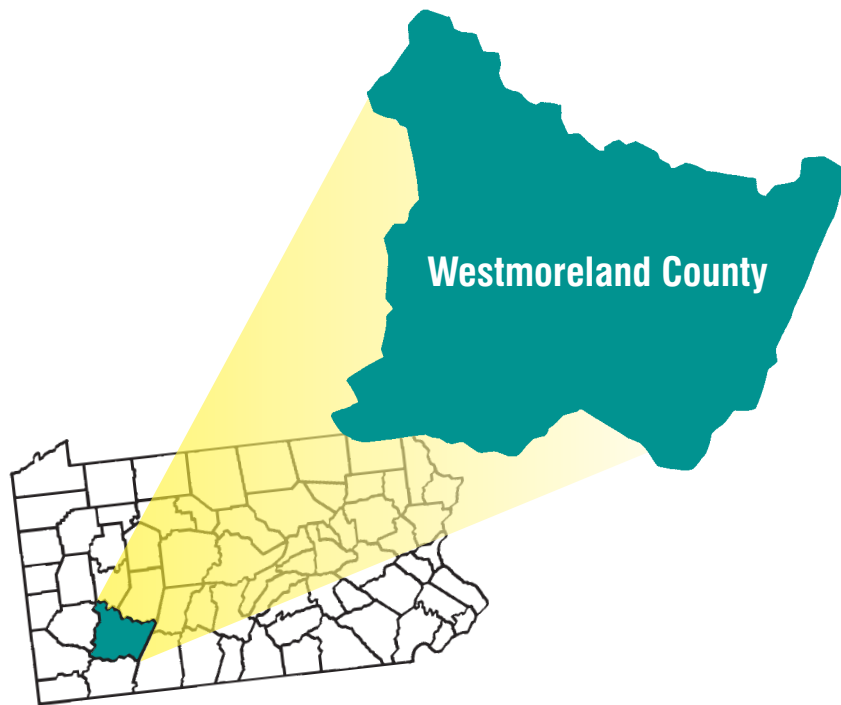

The location of Westmoreland County in Pennsylvania

### **WESTMORELAND CONSERVATION DISTRICT**

The Westmoreland Conservation District (District) promotes clean streams, stable soils, healthy forests, productive farms, and sustainable communities throughout Westmoreland County. Established in 1949, the District has been successfully encouraging loggers, earthmovers, developers, farmers, and others whose daily work directly affects our natural resources to voluntarily incorporate conservation practices in their projects and so protect the quality of our soils, forests, and streams.

In growing communities, the need for sustainable management of our water resources is spurred by land development that exchanges open space for the hard, impervious surfaces of driveways, parking lots, and building roofs. In older, urban areas, the catalyst is the limited capacity and age of our water supply, waste water and storm sewer infrastructure. Residential development alone has been adding an additional 41 million gallons of stormwater runoff annually in Westmoreland County in recent years, increasing pressure on our infrastructure, swelling small streams, and carrying a growing load of pesticides, road salts, pet waste, and other pollutants into our waterways. The increase in land development and stormwater runoff has created a variety of serious challenges to sustaining our water resources for our communities — availability of adequate water supply and waste water management, frequent flooding, expensive repairs of aging storm sewer systems, and compromised water quality.



Westmoreland Conservation District office in Greensburg, PA

Photo by Kathy Hamilton



## SUSTAINABILITY

The Westmoreland County Integrated Water Resources Plan (IWRP) focuses on keeping our water resources sustainable. Sustainability is the convergence of economic, social, and environmental issues. Westmoreland County's economic issues include the cost for development and maintenance of water resources and infrastructure as well as all costs related to stormwater: its control, its effects, and damages from flooding. The social issues involve all Westmoreland County residents and visitors that rely on clean water, expect quality waste water management, and are adversely affected by flooding. Environmental issues include the importance of water quality and effects of pollutants on drinking water, wildlife habitats and ecosystems, as well as erosion and stream degradation from excess stormwater that contributes to flooding and the damages that may occur. It is the goal of the IWRP to make Westmoreland County's water resources sustainable into the future.



**The Integrated Water Resources Plan (IWRP)** is a county-wide plan to address ALL water resources:

- Water bodies, waterways, and wetlands
- Groundwater
- Drinking water
- Waste water
- Stormwater

The IWRP meets the requirements of PA Stormwater Management Act 167, inventories and evaluates our county-wide water resources, and the impacts human activity has on them, provides guidance for our landowners and municipalities involved in development and redevelopment, and presents an action plan to address the issues and challenges that sustaining our water resources will pose into the future.

The **Pennsylvania Stormwater Management Act 167** of Oct. 4, 1978, (P.L. 864, No. 167) provides for the regulation of land and water use for flood control and stormwater management purposes, imposing duties and conferring powers on the PA Department of Environmental Protection (DEP), municipalities, and counties. The Act requires that each county prepare and adopt a watershed stormwater management plan for each watershed located in the county in consultation with the municipalities located within each watershed, and review and revise the plan(s) at least every five years. The plans must be submitted to DEP for approval and municipalities must enact ordinances or regulations consistent with the plans.

The policy and purpose of Act 167 of 1978 is to:

- Encourage planning and management of stormwater runoff in each watershed that is consistent with sound water and land use practices.
- Authorize a comprehensive program of stormwater management designated to: (1) preserve and restore the flood carrying capacity of Commonwealth streams; (2) preserve to the maximum extent practicable natural stormwater runoff regimes and natural course, current and cross section of water of the Commonwealth; and (3) protect and conserve ground waters and groundwater recharge areas.
- Encourage local administration and management of stormwater consistent with the Commonwealth's duty as trustee of natural resources and the people's constitutional right to the preservation of natural, economic, scenic, aesthetic, recreational and historic values of the environment.

Learn more at [www.dep.pa.gov/business/water/cleanwater/stormatermgmt/pages/act-167.aspx](http://www.dep.pa.gov/business/water/cleanwater/stormatermgmt/pages/act-167.aspx)

In June 2010, L. R. Kimball completed **Phase 1 of the Act 167 Plan**, as mandated by the State. Their work is summarized in the final report titled 'Act 167 Scope of Study for Westmoreland County Stormwater Management Plan'. The report included a summary of county watershed characteristics, identified relevant stormwater related issues, prioritized county watershed areas of interest for modeling, and proposed a Phase 2 Scope of Work, schedule, and budget.

The report concluded that “the county-wide watershed planning process for Westmoreland County must be designed with the individual watershed characteristics in mind, as well as the resources (technical, political, and economic) of the County.” The plan also stated “The goal of Westmoreland County’s Act 167 planning process is to provide a county-wide comprehensive program for the planning and management of stormwater,” and that a stormwater management ordinance is required to “address stormwater related problems in critical areas throughout the County.” Each of the county’s municipalities “must adopt the resulting stormwater management ordinance, or amend and implement ordinances as necessary to regulate development in a manner consistent with the plan and the provisions of Act 167... [to] have a beneficial impact on the waters of Westmoreland County.”

Phase 1 recommended that the following county watershed areas of interest in current and future growth areas that have recurring flooding issues be included in more detailed hydrologic modeling, especially to determine recommended release rates for development and redevelopment:

1. Turtle Creek
2. Sewickley Creek
3. Kiskiminetas River – partial area of interest
4. Conemaugh River – partial area of interest
5. Loyalhanna Creek – partial area of interest
6. Monongahela River – partial area of interest
7. Allegheny River/Pucketa Creek/Plum Creek – partial area of interest
8. Jacobs Creek
9. Youghiogheny River - partial area of interest
10. Indian Creek

Additional high priority goals set forth by Phase 1 included updating the

only current Act 167 plan in the county for the Turtle Creek watershed, assessing and verifying obstructions and other stormwater issues in the county identified in Phase 1, and assessing stormwater impacts in the growth areas of the county identified by the report.

Refer to the final report 'Act 167 Scope of Study for Westmoreland County Stormwater Management Plan' June 2010, by L. R. Kimball.

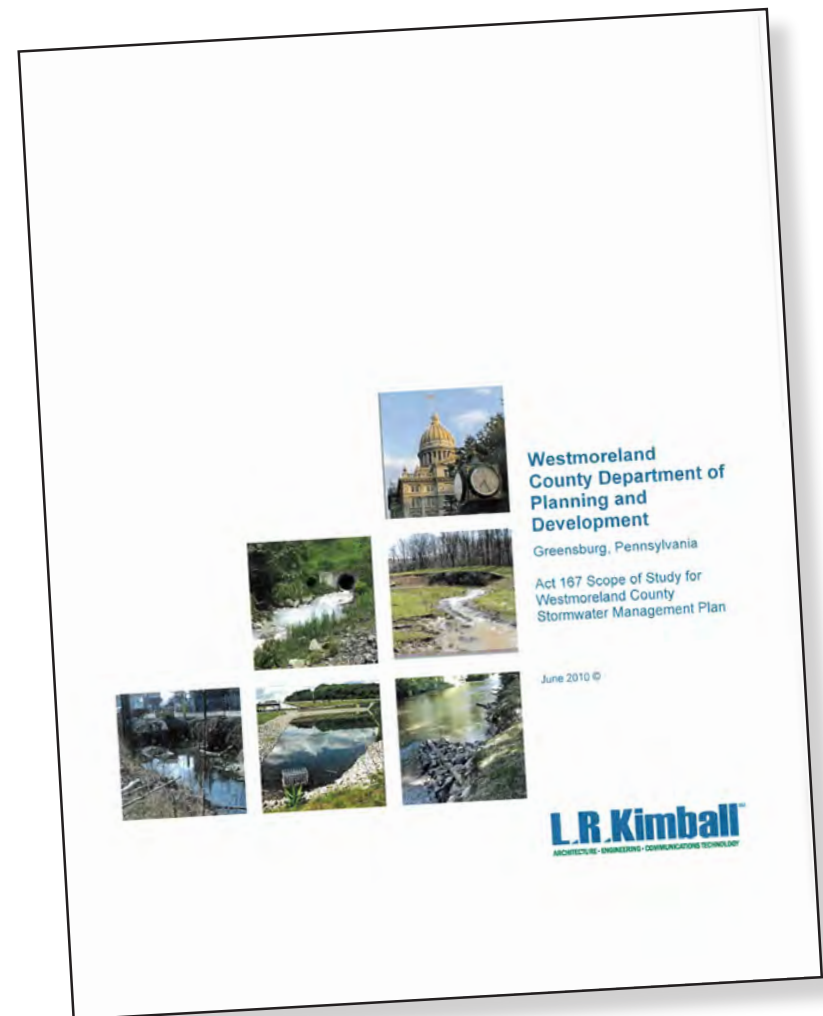

Cover of the Westmoreland County Act 167 Plan Phase 1 report, 2010













# Westmoreland County

Act 167 SWM Plan  
Phase 1 Scope of Study

**Figure 3**  
**Phase 2 Watersheds to be Modeled**

### SWM Problem Types

-  Accelerated Erosion
-  Flooding
-  Habitat Loss or Damage
-  Inadequate Infrastructure
-  Other
-  Sedimentation
-  Water Pollution
-  Act 167 Watersheds
-  Streams
-  Detailed Model Areas

### Legend

#### DISCLAIMER

No part of this document may be reproduced, stored in a retrieval system or transmitted in any form or by any means, electronic, mechanical, photocopying, recording or otherwise, except as expressly permitted by Elk County, PA.

This map was digitally compiled for internal maintenance and developmental use by Elk County, PA for reference purposes. Elk County, PA makes no claims as to the completeness, accuracy or content of any data contained herein, and makes no representation of any kind, including, but not limited to, the warranties of merchantability or fitness for a particular use, nor are any such warranties to be implied or inferred, with respect to the information or data furnished herein.

**L.R. Kimball™**  
ARCHITECTURE • ENGINEERING • COMMUNICATIONS TECHNOLOGY

415 Moon Clinton Road, Coraopolis, PA 15108

Prepared By: TCD  
Project No. 08-1300-0544

Date: 03-16-10

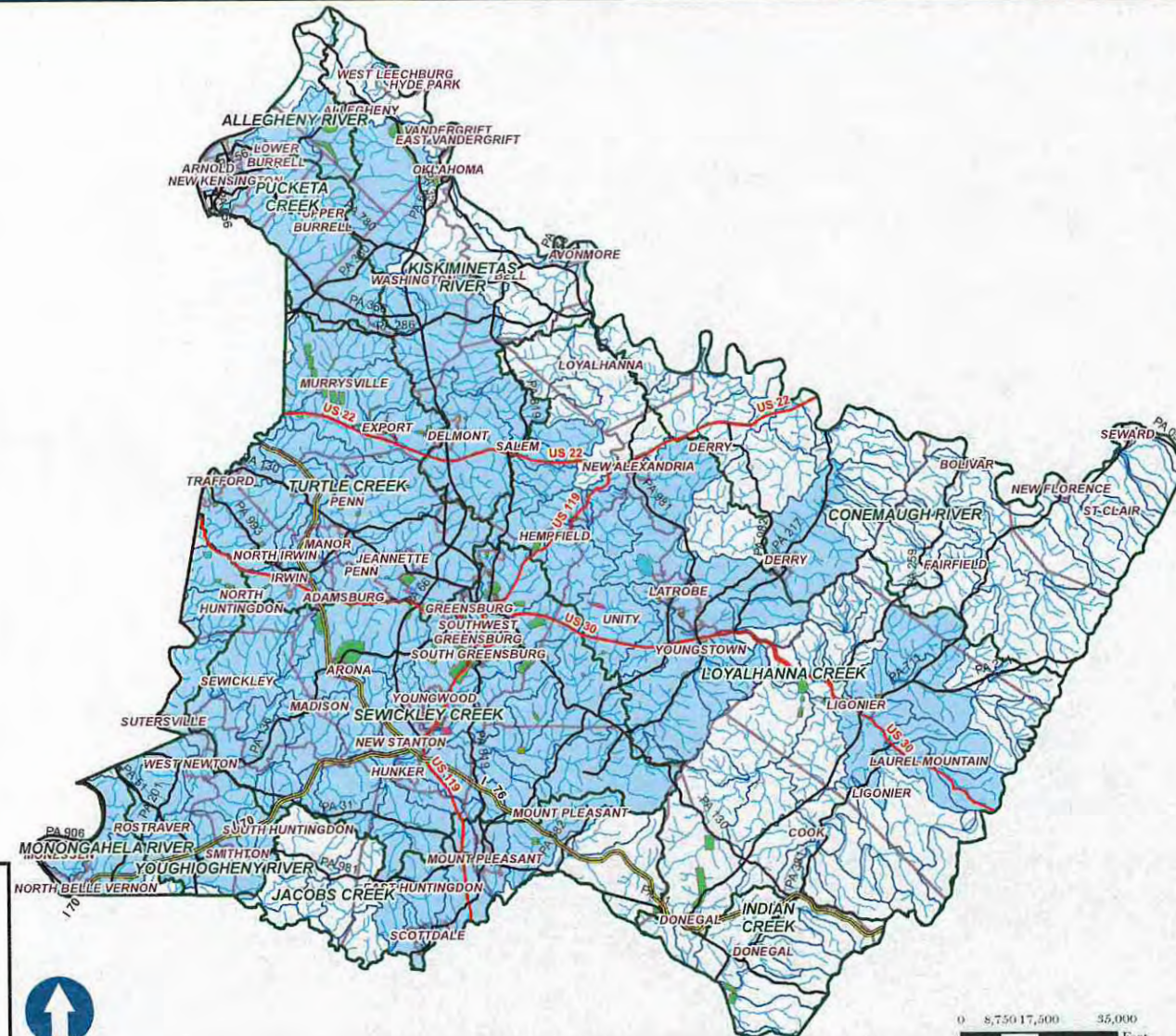

Location of Westmoreland County within Pennsylvania.



0 8,750 17,500 35,000  
Feet

Watershed areas of interest to be modeled from the Phase 1 Act 167 Plan report, 2010

For a complete copy of the Phase 1 report go to [www.spcwater.org/pol-167.shtml](http://www.spcwater.org/pol-167.shtml)

## GOALS

From a broad perspective, the Integrated Water Resources Plan (IWRP) has one focus: our county's water resources. Centered around this most valuable of all resources, the IWRP sets **four key goals** like four compass points giving direction and guidance to sustaining our water resources.

**Goal 1: Advance Sustainable Water Resources.** The Plan will identify specific steps to take towards sustainability of our county's water resources. Wise stewardship of water today means we will have water tomorrow—water for our industry, agriculture, domestic use, and recreation. In addition, sustainable water resources are those which are clean, not polluted; managed, not flooding; beneficial, not harmful; and abundant, not lacking. This Plan will both promote sustainable management of water resources and provide sustainable opportunities for addressing water issues.

**Goal 2: Encourage Partnerships to Support Water Resource Initiatives.** The Plan focuses on people and what they can accomplish as they work to protect, enhance, and conserve our streams, lakes, ponds, rivers, wetlands, and groundwater. From land developers to municipal officials, from farmers to urbanites, each county resident has a responsibility for water stewardship. This Plan will empower people to work together on various water-related projects.

**Goal 3: Provide Accessible Information on Water Resources.** To equip citizens, officials, decision-makers, and design professionals with the latest tools and information on water resources, the Plan calls for establishment of on-line resources including the decision-making Flowchart, an up-to-date Library, and a real-time Dashboard of stream and water data. The Plan gives access to data and mapping of water resources, watersheds, and impacts, and provides recommendations for action.

**Goal 4: Meeting Regulatory Mandates for Water Resources.** Various laws and regulations govern stormwater issues in Pennsylvania. The 'regulated community' interacts regularly with the Clean Streams Law, Act 167 of 1978, and the more recent MS4 regulations—each with unique and different standards. The IWRP establishes a firm yet flexible Model Stormwater Ordinance to set a standard for each County municipality to follow. It promotes the use of Best Management Practices for good stormwater management, and encourages municipalities to follow

the MS4 regulations. The Plan meets the requirements of Act 167, and creates a 'level playing field' for each of our county's 65 different municipalities with regard to stormwater.

## SCOPE OF WORK

The scope of work for the IWRP was initially developed from the Act 167 Plan Phase 2 scope of work proposed during Phase 1. Initially addressing only stormwater management, it was amended and broadened to include a more comprehensive approach to all of our county water resources. The IWRP Scope of Work included:

- Creating a watershed plan advisory committee (WPAC) to guide Phase 2 of the County's Act 167 Plan and IWRP in data collection, review, analysis and, decision making
- Collecting data, reviewing, and analyzing the county and all its water resources with regard to past impacts and future land development
- Modeling priority watershed areas of interest identified in the Act 167 Plan Phase 1, and creating decision-making guidelines for new development and redevelopment of our land related to water resources
- Determining the impacts land use has on our water resources and evaluating the issues and challenges we face in the future to sustain our water resources
- Developing an IWRP action plan to address sustainable water resources by:
  - Meeting the goals of the IWRP
  - Creating a decision making flowchart tool for all county residents and visitors involved in land development related to our water resources
  - Developing a model stormwater ordinance for adoption by all the county's municipalities to sustain our water resources into the future
  - Proposing solutions and potential projects to guide our county into a future with sustainable water resources
  - Assisting Municipal Separate Storm Sewer (MS4) municipalities and others to address sustainability and meet MS4 and other regulatory requirements.



## WATERSHED PLAN ADVISORY COMMITTEE (WPAC)

The Westmoreland County IWRP was developed by the District and the Westmoreland County Department of Planning and Development with the assistance of the WPAC. The WPAC is a team of local regulators, water resource managers, conservation organizations, and interested citizens who provided comprehensive information from across the county and each watershed and provided feedback and input throughout the plan development process.

The WPAC was drawn from individuals and representatives invited from across the region, reaching up to 300 members including:

- Westmoreland County Commissioners
- Westmoreland County Department of Planning and Development
- Westmoreland Conservation District
- 65 Municipalities
- Watershed Organizations
- Southwestern Pennsylvania Commission
- Conservation Organizations including but not limited to
  - US Army Corps of Engineers, PennDOT, PA Fish and Boat Commission, Pennsylvania Environmental Council
- Water & sewer agencies
- Citizens and property owners
- Concerned and interested regional neighbors

Input from WPAC members was key to the completion of the IWRP and included:

- Information exchange from the project team to communities in the county
- Identification of local strengths, problems and experiences
- Noted concerns and expectations of an IWRP to address stormwater and other issues with our water resources
- Comment and feedback on IWRP recommendations
- Encouragement of local input and adoption of IWRP and the Model stormwater ordinance

## FUNDING

The Westmoreland County IWRP was completed in-house by the District staff in partnership with the Westmoreland County Department of Planning and Development, the volunteer members of the WPAC, and with the assistance of Ethos Collaborative LLC, who completed the watershed modeling through a generous grant from the Richard King Mellon Foundation.



County Commissioner Chuck Anderson addresses members of the WPAC.

Photo by Kathy Hamilton

## Chapter 2. **WESTMORELAND COUNTY**



Photos by Stephen Simpson

Above - Jacobs Creek, Right - Flooded horse farm near Indian Creek

Westmoreland County is rich in water. It has approximately 2,037 miles of streams (according to PA DEP) with 131 named streams, 8.5 square miles of water, and about 2,200 acres of wetlands. With a population of over 350,000 people, personal interaction with water resources is a very common benefit of living here. Whether it's paddleboating on a lake in a county park, fishing along one of our many streams, or turning on a tap for a drink, our citizens enjoy frequent contact with water. On the other hand, our county has 4,713 miles of road, about half of which are in close proximity to a stream, leading to erosion of road shoulders, damage to bridges and culverts, flooding, and pollution. Countywide, the 2010 census data showed that 9,188 people lived in the 100 year floodplain, putting them at physical risk as well as increasing their risk of economic and property damage. Flooding issues however are not restricted to floodplains, as almost everyone knows someone who has had water in their basement or garage, with accompanying damage, even if they are not in a Federal Emergency Management Agency (FEMA) designated floodplain. So although our county residents benefit from our water resources, they also are faced with several water related concerns.

### HISTORY

Our county's earliest inhabitants, the Native Americans, had an intimate familiarity with our county's creeks and rivers. The Native Americans used the numerous streams for both food supply and travel. In a heavily-forested wilderness, the routes of the creeks and rivers made natural paths for the Delaware, the Lenape, and other tribes. The names which these native peoples gave the streams continue to this day.

Native American Stream Name	Meaning
Sewickley	<i>sweet water</i>
Kiskiminetas	<i>plenty of walnuts</i>
Conemaugh	<i>otter stream</i>
Loyalhanna	<i>middle stream (between the Juniata and the Ohio)</i>
Monongahela	<i>stream with falling (unstable) banks</i>
Allegheny	<i>best flowing river of the hills</i>
Youghiogheny	<i>stream flowing in a contrary direction</i>



Photo by Mark Jackson

Fly fishing on Loyalhanna Creek near Ligonier.



Our county's first European settlers arrived in the mid 1750s, about the time of the French and Indian War (1754-1763) and were both English- and German-speaking. The expedition of 1758 by General John Forbes to capture the site of Pittsburgh from the French led to the construction of Fort Ligonier along the Loyalhanna Creek. In 1768 the town of Hannastown was settled; it consisted of 30 log homes, two taverns, and a timber fort.

Westmoreland County was established on February 26, 1773, through an approved Act of Assembly by Governor Richard Penn. It was the



Photo by Mark Jackson

*Historic Fort Hannastown, Greensburg, PA*



Photo by Kathy Hamilton

*Tavern and kitchen at historic Hannastown, Greensburg ,PA*

first county in Pennsylvania located entirely west of the Allegheny Mountains. Hannastown was the county's first seat, and was home to the first English court of law west of the Allegheny Mountains from 1773 to 1787.

As early settlers pushed westward, they followed the native paths and the streams. Traveling to the 'Northwest Territory' (now called Ohio) in 1788, a group of New Englanders led by General Rufus Putnam followed the historical Glades Pike (now Route 31) to the Youghiogheny River. At the location we now know as West Newton, they built boats and traveled down the Youghiogheny, the Monongahela, and the Ohio Rivers to get to their new homes – the first of many frontier excursions launched at West Newton.

Westward expansion, the growing need to export agricultural products, and the advent of the coal and iron industries in Western Pennsylvania led to important water-based transportation improvements. During springtime high water, it was relatively easy to float down many of Westmoreland County's streams. Summertime, however, was a different story. The 1830s saw the construction of some rudimentary low-head dams on area rivers to create higher water for boats, and in 1831 the first canal boats were able to travel from Johnstown to Pittsburgh by the state-authorized route of the Main Line of Public Works, as the canal was called, which followed the Conemaugh, Kiskiminetas, and Allegheny Rivers. The Johnstown Flood of May 31, 1889, which killed over 2,200 people, was caused by the collapse of a large earthen dam



Photo by Kathy Hamilton

*Canal boat model from the C&O Canal Museum*



which had originally been built to help supply water to the Pennsylvania canal system. At the time it was built, the South Fork Dam was the largest in the country.

As the railroads pushed west, they also followed the rivers, because water routes have relatively gentle slopes for trains to ascend. By 1854, the Pennsylvania Railroad had built its (then) two-track main line through Westmoreland County, following the Conemaugh River in the east and, the Brush Creek valley in the west all the way to Turtle Creek and the Monongahela River. The demand for water by Pennsylvania's locomotives led to the construction of various reservoirs along its routes, including the Indian Creek water system comprised of a large masonry dam in Fayette County and a large-diameter water main running from there all the way to the Main Line in Westmoreland County.

The industrialization of Westmoreland County placed serious demands on water resources. In order to mine coal, water had to be pumped out of active mines, and this water was simply discharged into the nearest stream. Water was also used for washing and sorting coal



*The Pennsylvania Railroad built bridges and tunnels, moved mountains and relocated streams, bending nature to their will for many years as the economic powerhouse in the state. Today many of the civil works of the railroad remain in daily use, well over a century after their construction.*

Photo by CJ Bolish

and to quench coke ovens – in all, estimates are that the coal mining process used between 800 and 3,000 gallons of water per ton of coal produced. Coal was first mined near Fort Pitt in 1761. By 1910, 44,252 of the 55,166 coke ovens in Pennsylvania were located in the Connellsville Coke Region, stretching from Latrobe in Westmoreland County to the middle of Fayette County. In 1918, Pennsylvania's peak coal-production year, 330,000 miners produced 277,000,000 tons of coal – much of it in Westmoreland County. Our county's steel (Monesen and Latrobe), glass (Jeannette), and aluminum (New Kensington) industries active up until the late 1970s, also used water for various processes. Before the passage of the Federal Water Pollution Control Act in 1948, any wastewater was simply dumped in the rivers. In fact, one of the reasons for construction of the Youghiogheny Dam in 1943 was to dilute pollution in the Monongahela, so as to provide a source of clean water during times of low flow.



*Coke ovens at Mammoth County Park c. 1990; the ovens have since collapsed and were removed.*

Source - Westmoreland County Parks

In 1913, the automobile was still in its infancy. Those that had cars found road conditions were often unsuitable for driving. City streets were paved, but rural roads were primarily dirt tracks connecting farmlands. Automotive executive Carl Fisher's idea of a cross-country highway took shape in the Lincoln Highway (Route 30). In Pennsylvania, much of the Lincoln Highway was constructed by improving and linking up pre-existing roads, like portions of Forbes Road in Westmoreland County. By 1926, the federal government had established the major cross-country routes such as US 22 (the William Penn Highway) and US 30. The construction of the PA Turnpike in 1940 (its western terminus was at Irwin on Route 30) and Interstate 70 westward from New





Photo by Kathy Hamilton

*The Lincoln Highway Experience roadside attraction at Kingston Dam, which is between Latrobe and Ligonier*

Stanton sealed our county's destiny as a transportation hub. Today there are over 8.9 million daily vehicle miles of travel in our county!

Westmoreland County's development spread naturally along the rivers and creeks, and with limited flat land available, encroachment on the



Photo by Mark Jackson

*The Pittsburgh Model A Ford Club participates in the annual Fort Ligonier Days Parade in downtown Ligonier, PA. Ligonier is a Lincoln Highway Community.*

floodplain became inevitable. Before the advent of large earthmoving equipment, floodplains were the only flat land to be found, and industry and towns built there. Buildings in a floodplain are vulnerable to damage or destruction, and placing fill to elevate them out of the floodwater merely shifts the damage elsewhere as natural flood storage areas are lost. The Saint Patrick's Day Flood of 1936, Hurricane Agnes in 1972, the 1977 Johnstown flood, and the Election Day flood of 1985 are milestones in our county history. Floods have always been Westmoreland County's number one natural disaster, yet for many years the lure of developing cheap flat land in the flood plain prevailed.



Photo - Pittsburgh Post-Gazette

*Saint Patrick's Day Flood of 1936, at the confluence of the Allegheny and Monongahela Rivers, Pittsburgh, PA*

People need water. Our earliest settlers located near water; many of our oldest farmhouses have a springhouse nearby. As the towns grew into cities, the need for water supplies continued to expand. Studies show that one hundred years ago, the average household used five gallons per person per day. Of course this was to be expected when one would have to pump and carry all the water by hand. Today, an average residential user will need 65 gallons per day. There are ten water-providing authorities in Westmoreland County serving over 170,000 customers with more than 100 million gallons daily. Some residents have a private water supplier, but the more rural population relies on individual drinking water wells.





Source - Google

*Morning glory intake structure at Beaver Run Reservoir*

Westmoreland County also has 41 sewage treatment authorities serving over 180,000 customers and treating more than 65 million gallons daily. Other residents rely on small privately-operated sewage treatment plants, and the more rural populations rely on either individual septic systems to treat their wastewater or 'wildcat' sewers discharging to streams or mines. Combined sewers – (a single pipe under the



Source - Google

*Aerial view of FTMSA sewage treatment facility in Murrysville PA*

street that carries both sewage and stormwater) are common in our older communities and are a major source of stream and river pollution in the Pittsburgh area. Combined sewer overflows (CSOs) occur when storms overload the systems and discharge into our waterways.

Aside from requiring drinking water, and generating wastewater, our population growth (and population sprawl) generates more stormwater than ever before. Each rooftop, driveway, and parking space (no matter how infrequently someone parks there), generates stormwater runoff and stormwater pollution. A single residential rooftop in a one inch rain will generate over 600 gallons of runoff. This is not much, but in a developed township with several thousand houses, it adds up to millions of gallons of stormwater.

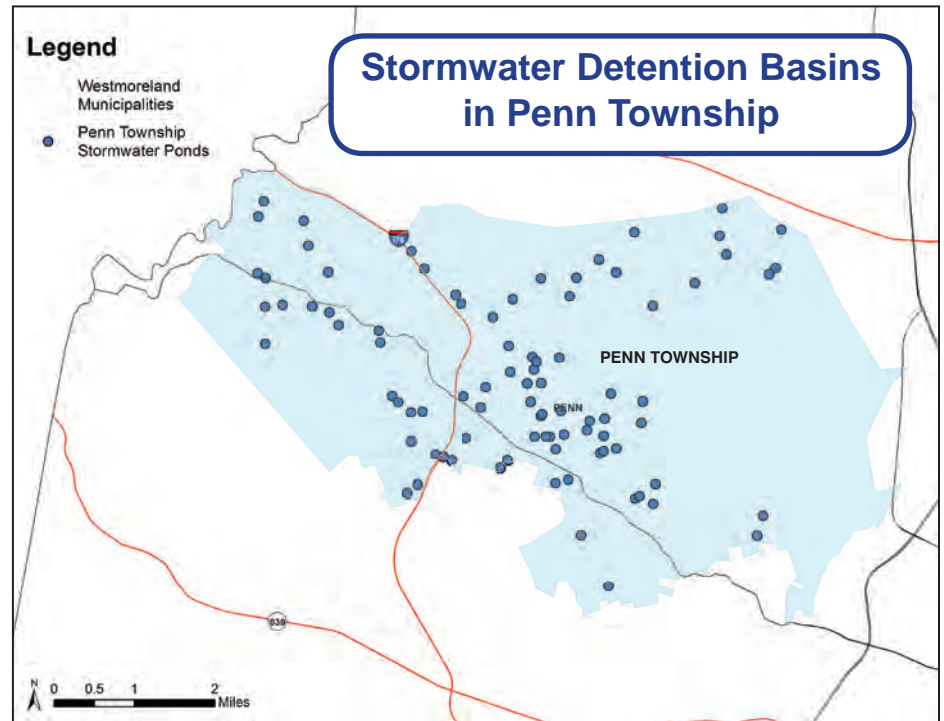

Data from Penn Township

*The number of detention ponds in Penn Township indicates the degree of development there.*



## OHIO RIVER BASIN

“Despite the state’s overall abundance of water, it is a finite resource and not always sufficiently available in areas where it may be needed. Through wise planning and proper management, water resources can be a renewable resource. Water conservation and sound water management strategies are essential to ensure that adequate water supplies will be available to protect public health, sustain economic development and protect agricultural and natural resources of the commonwealth.”

- from the *Pennsylvania State Water Plan*

In 2002, Pennsylvania passed the Water Resources Planning Act (Act 220) to provide guidelines for future water resource planning that will influence the future allocation of groundwater and surface water. It mandated the development of a State Water Plan by 2008, and required that it be updated every five years. The State Water Plan is a non-regulatory guidance document that shows how much water we have, how much we use, and how much we will need in the future with the intent to minimize future conflicts over water. Act 220 established a statewide water withdrawal and use registration and reporting program, whereby large scale water users (greater than 10,000 gallons per day) should register their use. Users of less than 10,000 gallons per day are encouraged to register as well. The Act called for the identification of critical water planning areas (those areas where existing or future demand will exceed the water available), the creation of critical area resource plans for each of the designated critical areas, and general regional plans and priorities. It also established a voluntary water conservation program.

Last updated in 2009, Pennsylvania’s State Water Plan is a roadmap for the future of our water resources. The Pennsylvania State Water Plan divides the state into six major watershed regions. Westmoreland County is in the westernmost region – the Ohio River Basin, which drains to the Mississippi River. The 981 miles of the Ohio River from Pittsburgh, PA, to Cairo, Illinois, drain over 200,000 square miles in 15 states. The Ohio Region is the second largest basin in Pennsylvania covering 15,614 square miles, which only accounts for less than one tenth of the entire Ohio River basin. Westmoreland County contributes just over 1,000 square miles to the Ohio River Basin, draining to four of its seven major tributaries: Allegheny River, Kiskiminetas and Conemaugh Rivers, Youghiogheny River, and the Monongahela River.

## Westmoreland County - USA Watershed View



The Water Resources Planning Act created regional water resource committees to ensure individual regional priorities were developed and highlighted in the State Water Plan. The following goals identified by the Ohio Regional Water Resources Committee reflect specific concerns regarding water quality and quantity in the region:

- Reclaim water resources impaired by abandoned mines
- Identify water resources needed to promote and facilitate economic development
- Reduce and avoid impacts that may lead to contamination
- Control stormwater runoff and promote groundwater infiltration
- Resolve problems associated with aging infrastructure
- Develop plans for water resources during shortage emergencies
- Protect and restore water resources
- Develop and encourage use of appropriate applied technology
- Identify water resources needed for economic development; and
- Distinguish the Ohio River Basin.

– Summarized from the PA State Water Plan

# NATURAL FEATURES

## GEOLOGY

Westmoreland County lies in the Appalachian Plateau Province of Pennsylvania and is divided by the Pittsburgh Low Plateau Section in the west and the Allegheny Mountain Section along the eastern ridges (Chestnut and Laurel Hill), with the extreme southwestern part of the county in the Waynesburg Hills Section. The county includes an array

of geologic features with wide ridges, flat uplands, and valleys filled with alluvial deposits.

Bedrock in the county consists mostly of shale, sandstone, and siltstone, with widespread coal deposits. The variety of geologic formations creates a varied drainage pattern of surface water. Often groundwater travels to the nearest stream valley instead of moving deeper into the groundwater system. The concentration of cracks and fractures in the bedrock, however, increases infiltration rates and contributes to groundwater recharge.

*(From the PA State Water Plan)*

### Westmoreland County Geology

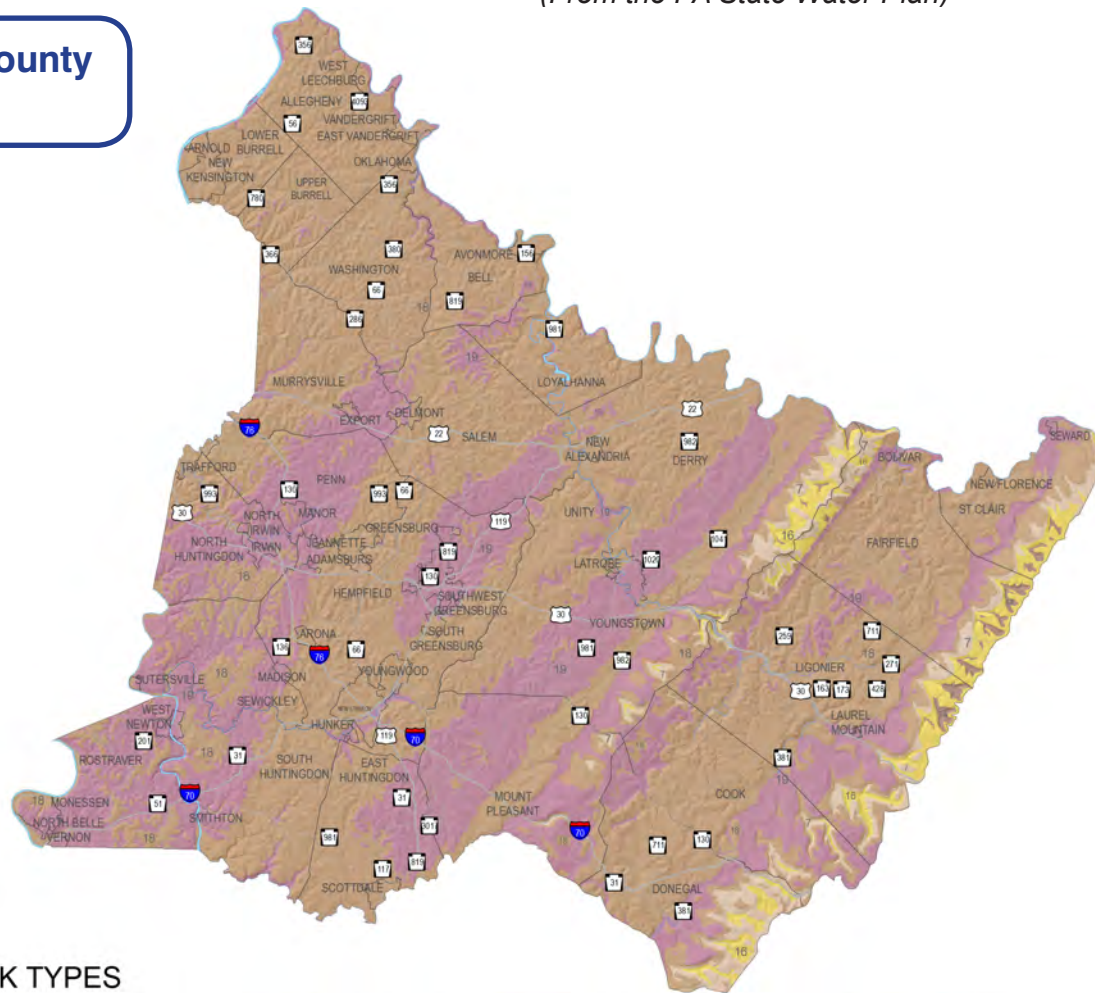

#### ROCK TYPES

- 7. Red sedimentary rocks\*
- 14. Sandstone\*
- 16. Sandstone, conglomerate
- 18. Mixture of rock types\*
- 19. Mixture of rock types\*

Source - PASDA



## SOILS

Pennsylvania's diverse geological formations have allowed for the development of a variety of soils. Most of our county's soils are a mix of silt and clay particles. Such soils are relatively easily molded when wet, can be compacted tightly, and have a slow rate of water movement. This allows someone to make a pond on their property – and indeed there are many ponds in Westmoreland County.

One water quality benefit of clay soils is that the clay particles, which have a slight negative charge, may capture and immobilize certain types of pollutants found in stormwater runoff, whereas in a sandy soil those pollutants might pass right through. The downside of the silt and clay soils is that these soils will have a higher rate of water runoff than a more sandy or gravelly soil. Land disturbance in a clay or silt soil will often compact a site's soils to the point where they are practically impervious, resulting in high runoff during storms. There are many soils in the Allegheny Plateau that have fragipans from 1-2 feet in depth composed of dense silt loams and loams which limit permeability.

There are approximately 125 soil types identified across Westmoreland County which can be grouped into eight main soil associations shown on the following map:

- (1) Laidig Hazelton Dekalb Association – Deep and moderately deep, well-drained to somewhat poorly drained soils on ridges; underlain by acid, gray shale and sandstone. This association occurs mainly on the Chestnut Ridge and Laurel Hill in the eastern part of the county at elevations below the Freeport coal seam.
- (2) Leck Kill Klinesville Calvin Association – Moderately deep, well-drained, red soils on ridges. This association occurs in the eastern part of the county on the upper most parts of Chestnut Ridge and Laurel Hill.
- (3) Philo Monongahela Atkins Association – Deep, moderately well drained to poorly drained soils on terraces and floodplains. This association occurs along the larger streams in the county.
- (4) Wharton Rayne Gilpin Association – Deep and moderately deep, well drained to somewhat poorly drained soils over acid, gray shale and siltstone. This association is steep, hilly and is generally found at elevations below the Pittsburgh coal seam.

(5) Dormont Culleoka Clarksburg Association – Deep and moderately deep, well drained to somewhat poorly drained soils over interbedded sandstone, shale, and limestone. This association consists chiefly of rounded hills that have long smooth, convex slopes, and of nearly level to gently sloping benches and fans. This association is mainly found in the west-central part of the county and is found at elevations above the Pittsburgh coal seam.

(6) Wharton Weikert Gilpin Association – Deep and moderately deep, well drained and moderately well drained soils over red and brown clay shale, siltstone, and sandstone. This association is gently sloping to steep and occurs in the northwestern part of the county. The steeper and more dissected slopes are nearer to the larger streams.

(7) Weikert Gilpin Ernest Association – Shallow, well drained, rocky soils on escarpments along streams. This association occurs as escarpments cut by Loyalhanna Creek and the Kiskiminetas, Conemaugh, Allegheny, Youghiogheny and Monongahela Rivers. The largest areas occur where the streams have cut across Chestnut Ridge and Laurel Hill. Most of the geologic formations in the county are exposed to these cuts. The rocks include sandstone, shale, siltstone and limestone.

(8) Newark Dormont Association – This association occurs along portions of the Turtle Creek corridor on the western edge of the county.





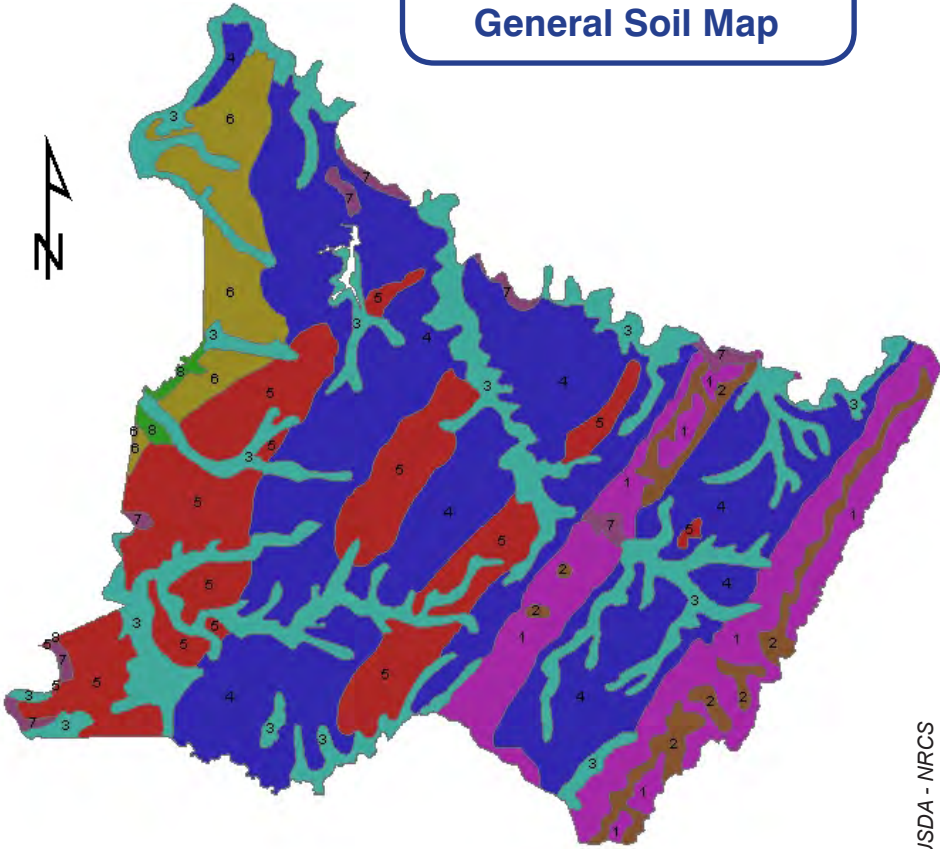



One particular type of soil found in Westmoreland County is more susceptible to landslides than others. The Gilpin-Upshur soils are found primarily in the northwest part of the county, although pockets exist elsewhere. These soils, sometimes called the “Pittsburgh Red Beds” are indeed a deep reddish or maroon color and have a high clay content. When wet, they can slip and slide, causing property damage. Many other soils in our county may slide if certain factors are present. Factors leading to landslides include overloading the top of a slope, excavating away the bottom of the slope, introducing extra water into slope soils, and dumping incompetent fill materials on a slope. Control of water in the soil is the principal way to prevent landslides. The use of subsurface drains, often called tile drains or French drains, can carry away excess groundwater and help stabilize a soil. Proper placement and compaction of soils on a slope will also help prevent landslides.

**Westmoreland County  
General Soil Map**



**General Soils Map**

**GSM**

- |  |   |
|--|---|
|  1 Laidig Hazleton Dekalb       |  5 Dormont Culleoka Clarksburg |
|  2 Leck kill Klinesville Calvin |  6 Wharton Weikert Gilpin      |
|  3 Philo Monongahela Atkins     |  7 Weikert Gilpin Ernest       |
|  4 Wharton Rayne Gilpin         |  8 Newark Dormont              |

Source - USDA - NRCS

**Westmoreland County  
Landslide Prone Soils**

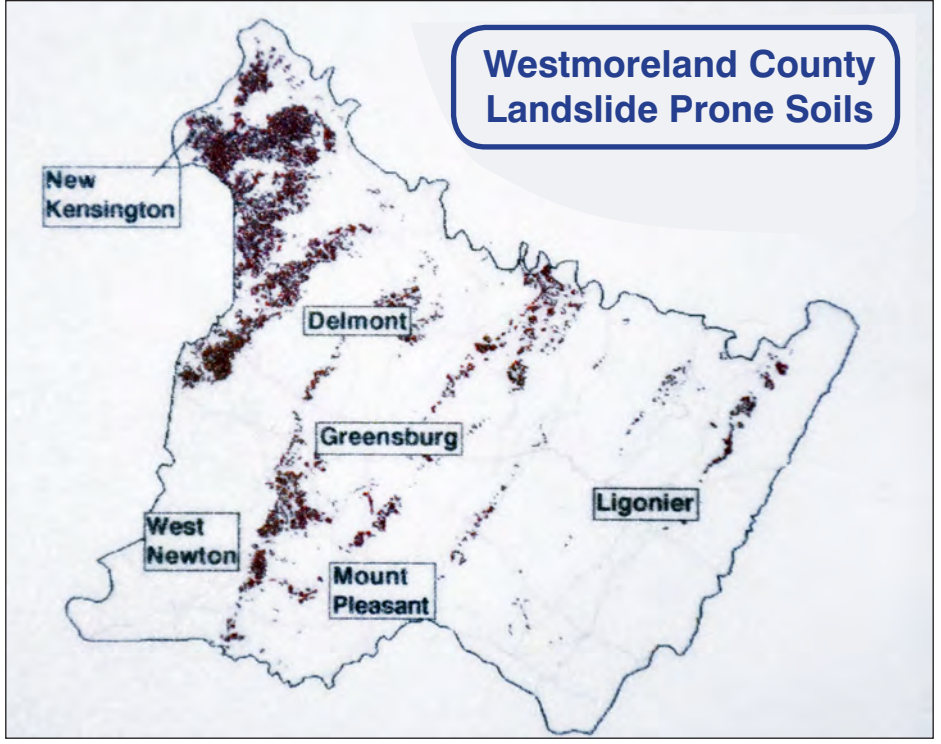

Upshur-Gilpin soil map

Source - WCD John Millen Soil Display



Recent landslide on Route 30, East Pittsburgh

Photo by KDKA-TV



## VEGETATION

Pennsylvania is home to a variety of native species from club mosses, grasses, sedges, rushes and wildflowers to woody shrubs, deciduous trees, and evergreens. The PA Department of Conservation and Natural Resources (DCNR) reports over 2,100 native species adapted specifically to our local climate and conditions like rainfall and soils. In addition to native plants, there are over 1,300 non-natives which have been introduced to the local environment since Europeans settled in the area starting in the 1700s. Both native and non-native plants provide habitat and food for insects, birds, animals, and more. They help



Photo by Kathy Hamilton

### *Mountain Laurel*

stabilize soil and streambanks and provide the necessary evapotranspiration to complete the natural water cycle by capturing rainfall, pulling it out of the soil, and transpiring it back into the air. Plants also perform many functions for people like filtering water, storing carbon, providing food, medicine, and raw materials for construction as well as contributing aesthetics to our environment and opportunities for recreation.

Visit [www.dcnr.pa.us](http://www.dcnr.pa.us) for more information on native plants and invasive species.

Vegetation can also be used for phytoremediation to clean up contaminated environments. Plants can help clean up many types of contaminants including metals, pesticides, explosives, and oil. Certain plants are able to remove or break down harmful chemicals from the ground when their roots take in water and nutrients from the contaminated

soil, sediment, or groundwater. Plants also help prevent wind, rain, and groundwater flow from carrying contaminants away from the site to surrounding areas or deeper underground.

Phytoremediation can be beneficial for many reasons. It takes advantage of natural plant processes and requires less equipment and labor than other methods since plants do most of the work. Also, the site can be cleaned without digging up and hauling soil or pumping groundwater, which saves energy. Trees and smaller plants used in phytoremediation help control soil erosion, make a site more attractive, reduce noise, and improve surrounding air quality.

For more information visit <https://www.epa.gov>



Photo by Chris Droste

### *Phytoremediation on industrial site in New Stanton, PA*



## SLOPES

From the higher elevation Laurel Ridge and Chestnut Ridge in the east, to the steep-sided creek valleys on our county's western side, there is not much natural flat land in Westmoreland County. Steep

slopes cause increased stormwater runoff, and what runs off will have a higher velocity, leading to erosion of soils and channels.

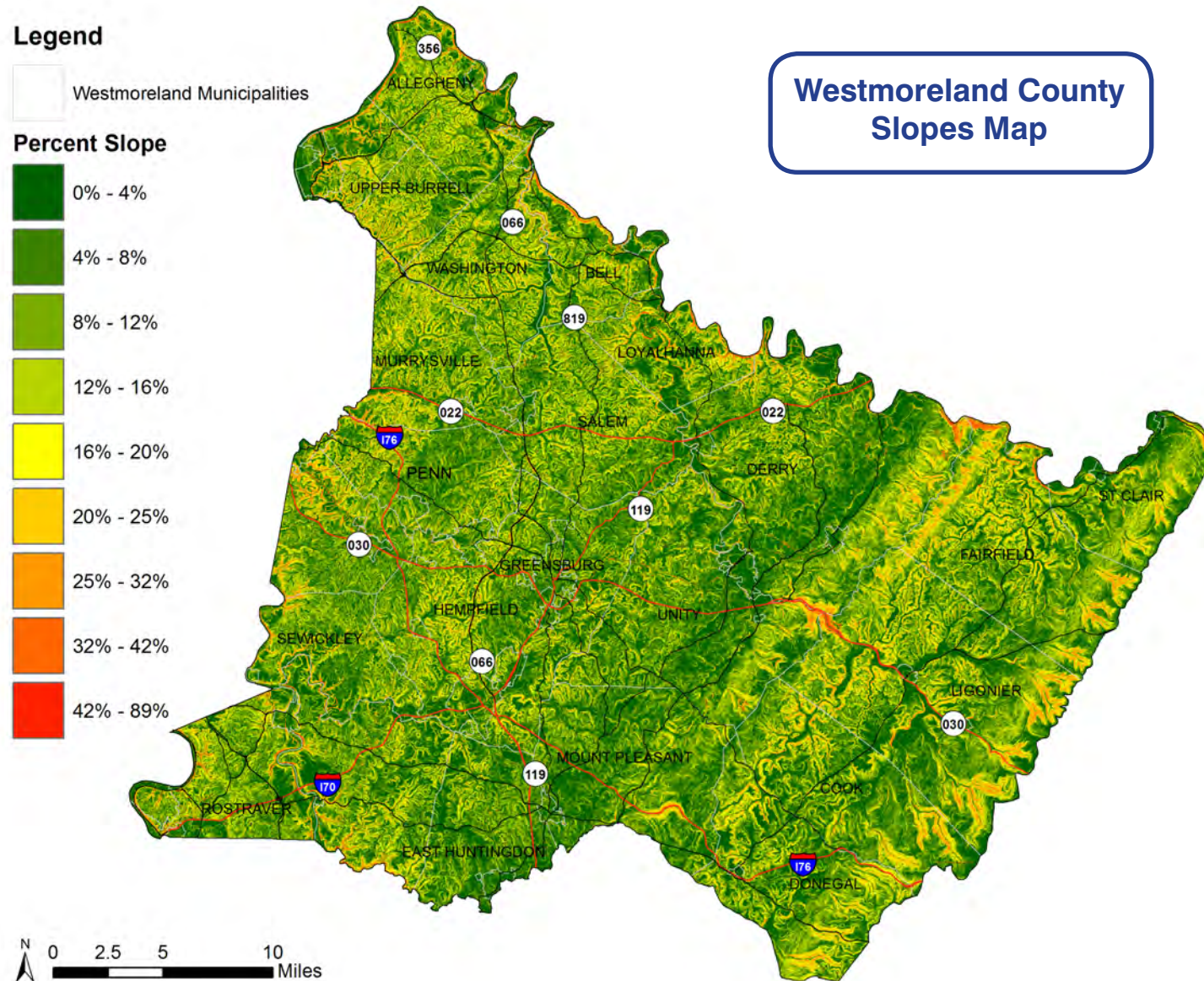

Source - PASDA



## ELEVATION

Much of the elevation change in our county is concentrated in the east, where the two ridges rise abruptly from the surrounding land. The high ridges limit most development activity to the western two-thirds of our

county. At the higher elevations, the steepness of the slopes and the rocky thin soils make it difficult to drill for clean water and to dispose of waste water.

### Legend

 Westmoreland Municipalities

### Elevation

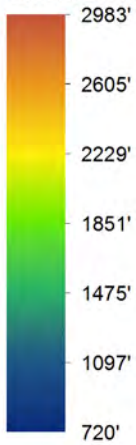

## Westmoreland County Elevation Map

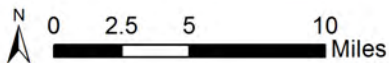
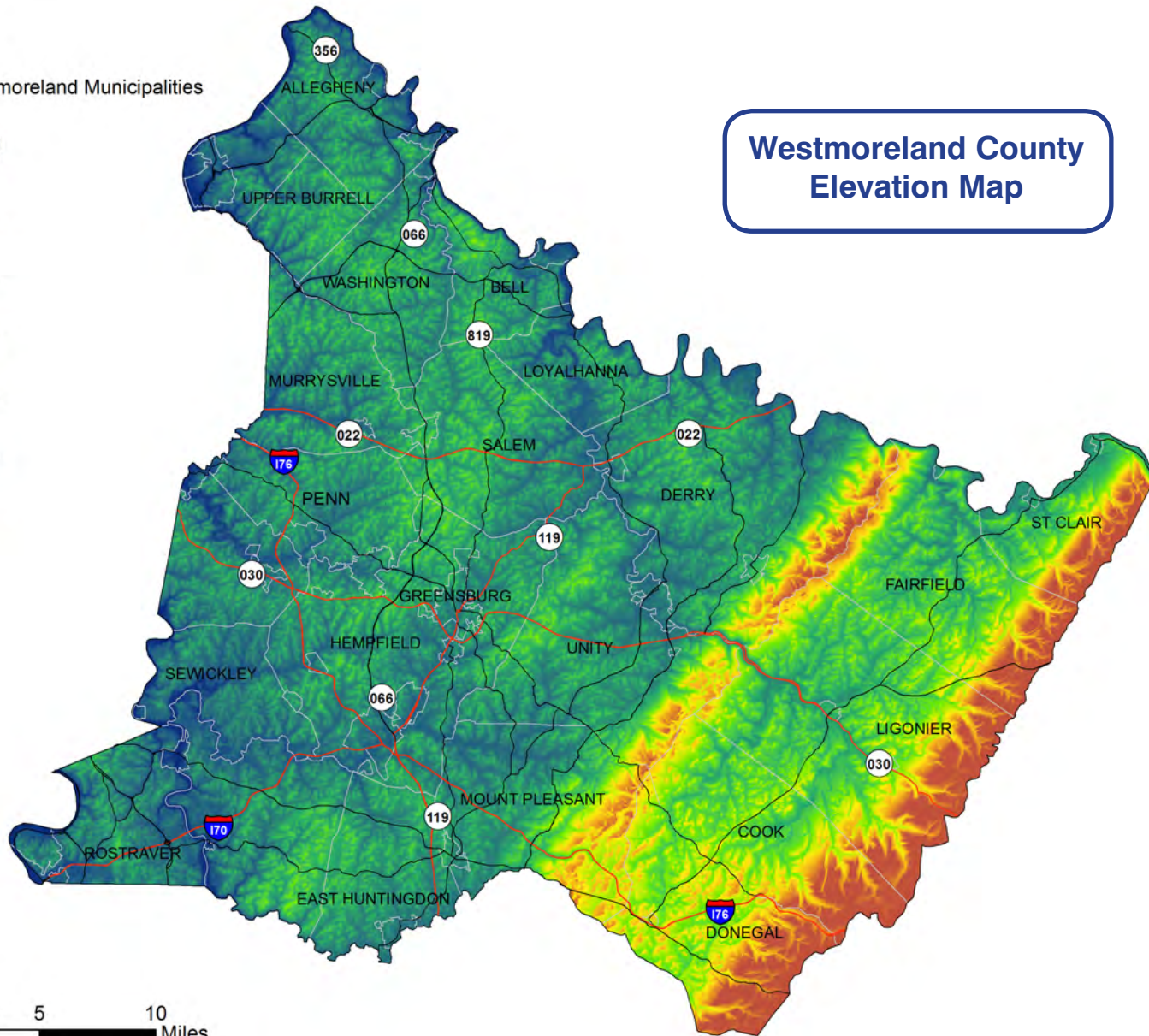

Source - PASDA

## CLIMATE

Residents and visitors to Westmoreland County enjoy comfortable weather nine months out of the year – and all twelve, for those who enjoy snow! Westmoreland County has a temperate climate pattern with mean temperatures that range from 19 to 84 degrees Fahrenheit, and average annual precipitation of 40 inches, increasing five inches from the west to east. The City of Greensburg is located in the center of the county and [www.city-data.com](http://www.city-data.com) shows that the average temperature ranges from the mid-20s to 70 degrees Fahrenheit throughout the year,

with the hottest months being July and August. Precipitation averages approximately three inches per month with the most, over four inches, occurring in May and the least, just over two inches, in October. City-data also reports only 20% of days throughout the year are clear of clouds, with 30% being partly cloudy, and the remaining 50% cloudy, with humidity ranging between 50 and 80% throughout the year.

Learn more: <http://www.city-data.com/city/Greensburg-Pennsylvania>.

### Average climate in Greensburg, Pennsylvania based on data reported by over 4,000 weather stations

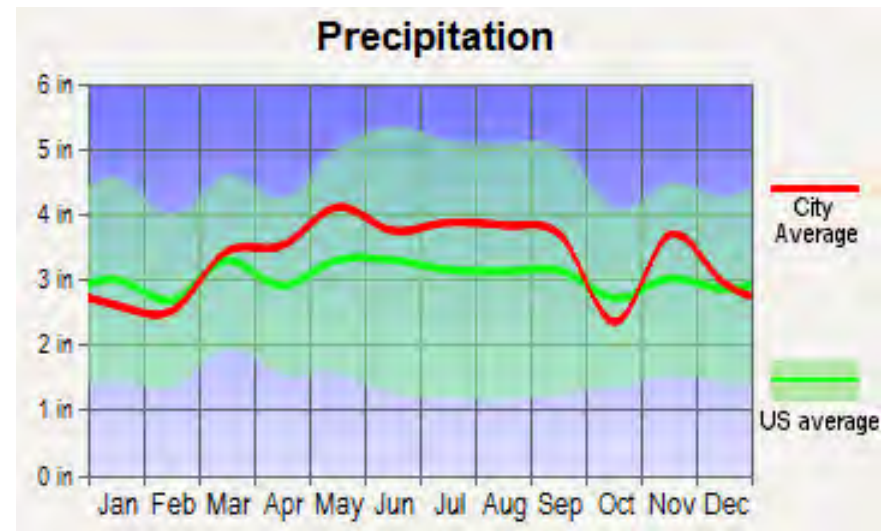
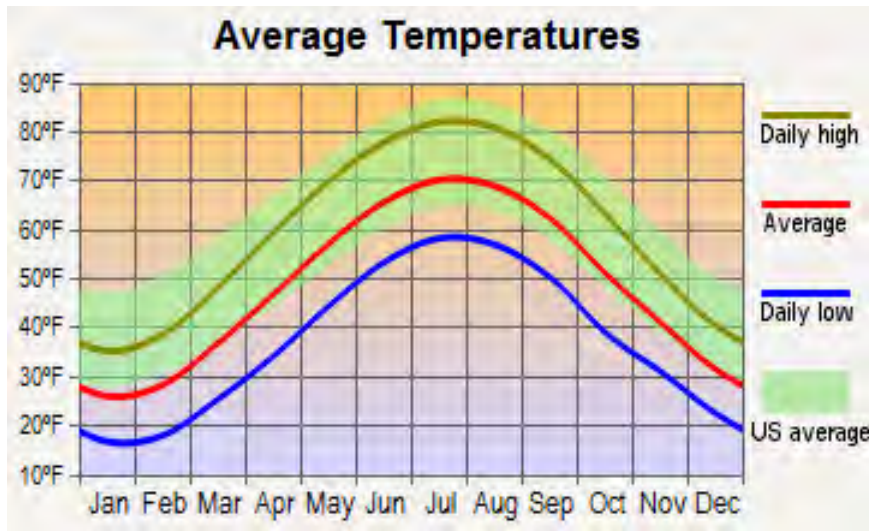



## POPULATION AND POLITICAL BOUNDARIES

Westmoreland County is a mix of urban and rural neighborhoods with seven cities, 37 boroughs, and 21 townships, with a total of 65 incorporated municipalities in all. The county's population in 2016 was 355,458 (75% urban, 25% rural), slightly less than it was in 2000 at 369,993,

with a population density of 347 people per square mile, which is higher than Pennsylvania's average of 286. The county's land area is 1,025 square miles and the water area is 8.5 square miles.

Read more: [http://www.city-data.com/county/Westmoreland\\_County-PA](http://www.city-data.com/county/Westmoreland_County-PA).

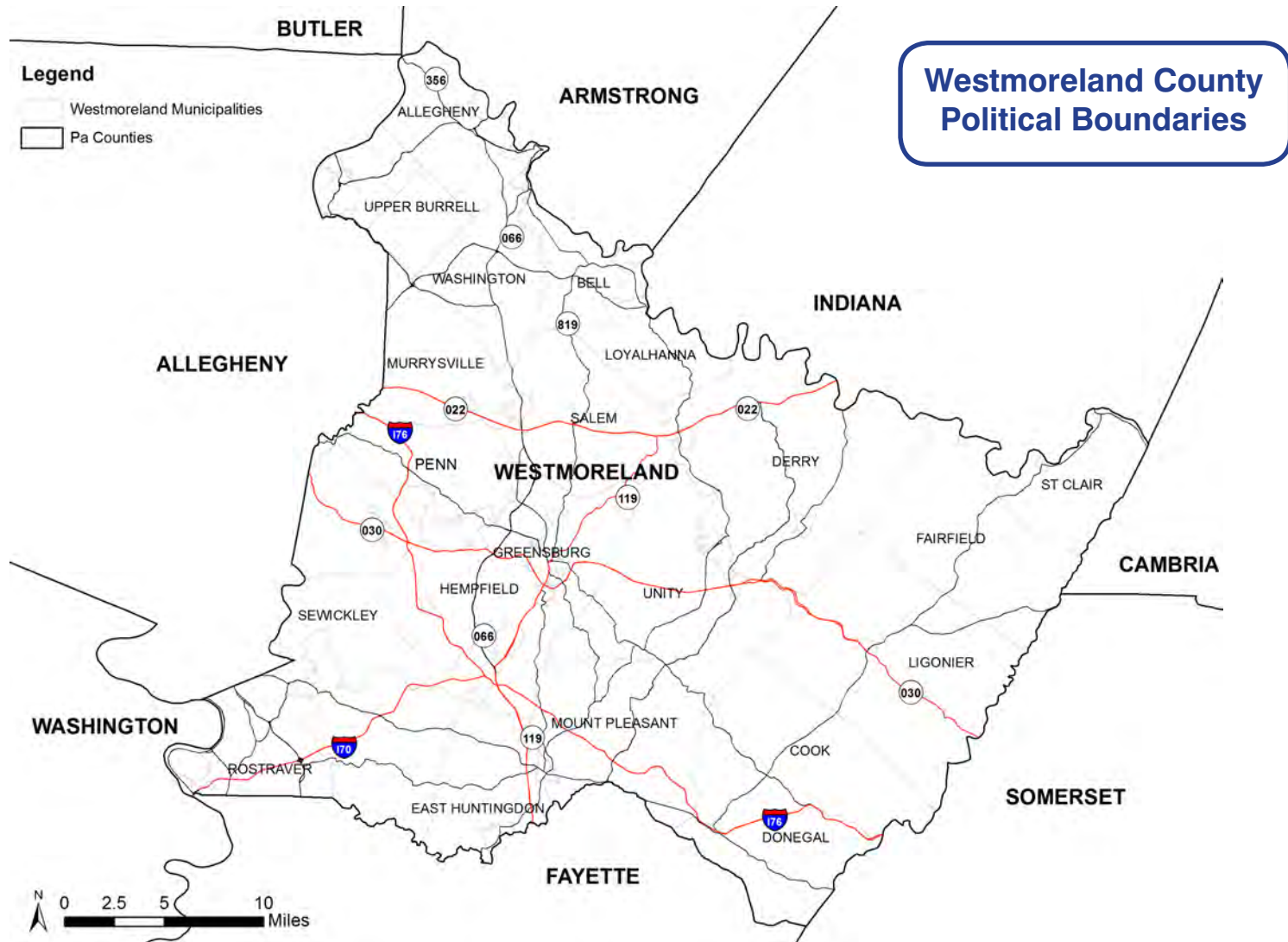

## LAND USE

Approximately 50% of Westmoreland County is natural area with another approximately 25% in agriculture and open space. Westmoreland is a very green county, which is a benefit to our water resources, as it protects source water and headwaters of high quality and

exceptional value streams. Agriculture combined with urbanization however can be a liability as agricultural practices and development have encroached on low lying areas and floodplains. Older communities with aging or limited infrastructure can also reduce sustainability of our water resources. – *Reimagining Our Westmoreland*

### Legend

- Westmoreland Municipalities
- NLCD 2011**
- Woody Wetlands
- Shrub/Scrub
- Open Water
- Mixed Forest
- Herbaceous
- Hay/Pasture
- Evergreen Forest
- Emergent Herbaceous Wetlands
- Developed, Open Space
- Developed, Medium Intensity
- Developed, Low Intensity
- Developed, High Intensity
- Deciduous Forest
- Cultivated Crops
- Barren Land

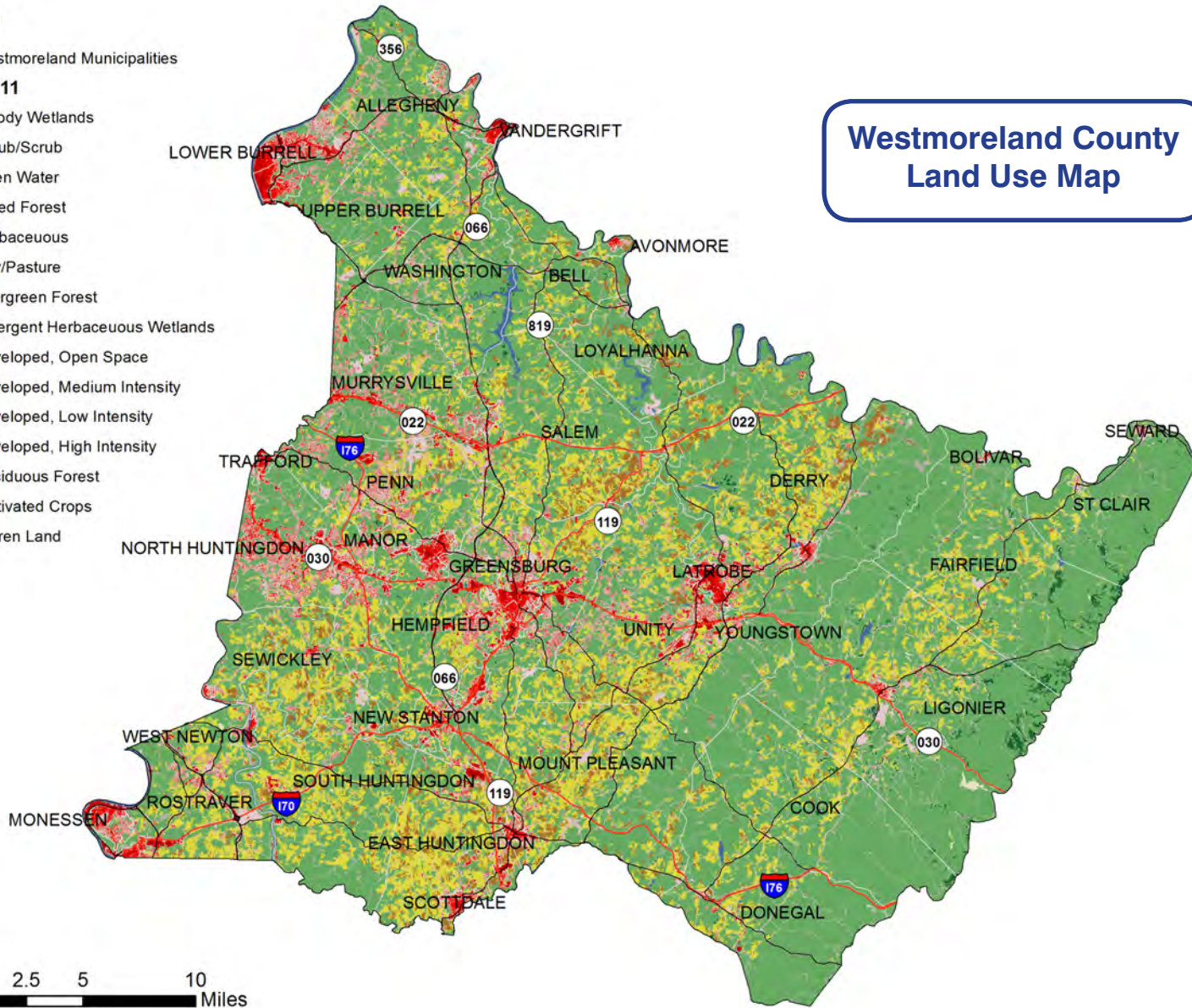

**Westmoreland County  
Land Use Map**

Source - SPC / NL CD (2011)



## EXISTING LAND USE

The Existing Land Use map's land use categories are based on the Southwestern Pennsylvania Commission Land Use/Land Cover (LULC) classifications and Westmoreland County's 2010 assessment of existing land use.

For the purposes of this analysis, land designations have been grouped and consolidated into ten land use categories:

- Agriculture - areas used for raising crops and livestock
- Residential - all housing types including, but not limited to single-family and multi-family dwellings
- Commercial - retail, service, and office uses
- Industrial - manufacturing, production, and distribution
- Institutional - schools, churches, and government facilities
- Parks and Open Space - municipal parks
- Natural Areas - undeveloped areas with heavy tree cover, including state parks and conservation areas
- Transportation and Utility - rail, airport, and roadway and utility rights-of-way
- Extraction - mining operations
- Vacant/Transition - vacant land or land that may be suitable for redevelopment

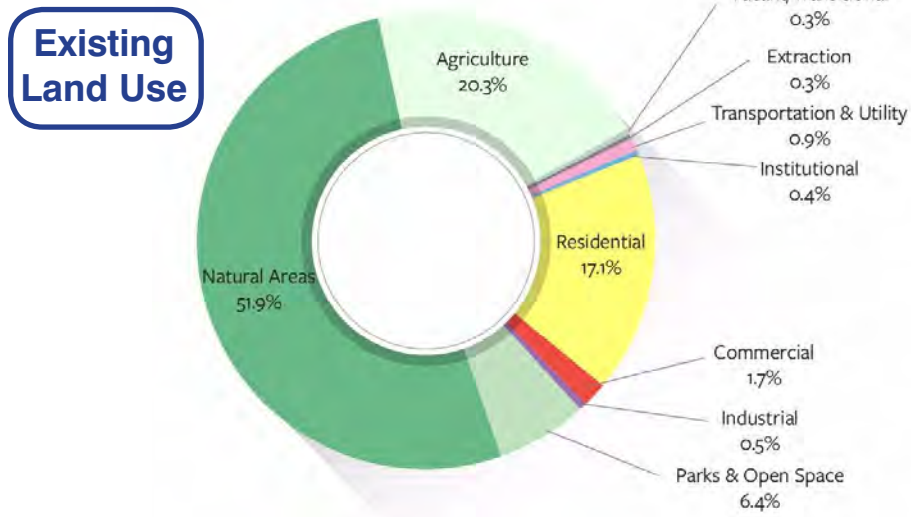

Source - Reimagining Our Westmoreland

## COUNTY COMPREHENSIVE PLAN

In 2016, Westmoreland County began updating the county comprehensive plan. The new plan, Reimagining Our Westmoreland, creates a blueprint for our future to help the county become more livable and prosperous. Reimagining Our Westmoreland serves as the county's official guide for land use and development over the next 10-20 years. It is Westmoreland's "road map," detailing a long-term vision and policy agenda for important quality of life issues like land use, housing, parks, infrastructure, transportation, and more. The county comprehensive plan investigates and answers: "What should Westmoreland County look like in 10-20 years and how do we get there?"

The IWRP is part of Reimagining Our Westmoreland and will provide a one-stop shop for information concerning various water resources such as drinking water, waste water, stormwater, streams, wetlands, and water bodies. Providing technical assistance to the public, municipalities, and design professionals, the IWRP will help guide growth and development while conserving our valuable water resources for future generations. The creators of the IWRP hope people will ask this question: "What should Westmoreland County's water resources be like in 10-20 years, and how do we get there?"

To find out what Reimagining Our Westmoreland has to say about population, business, housing, transportation, public safety, utilities, land use and development as it relates to our water resources, visit <https://www.co.westmoreland.pa.us/>

## POPULATION

Westmoreland County's population is a prominent concern for three reasons: it has been decreasing, aging, and lacking diversity. The projection based on births, deaths, and net migration estimates that Westmoreland County's population will decline by 1.2% by 2030. Current census estimates place Westmoreland's population at 2.7% below its 2010 level. Westmoreland's population decline is expected to continue.

This means fewer workers in the future, which correlates to a declining economy and decreased tax revenue. An aging and shrinking population means land use and transportation patterns will need to be adjusted. Optimistically, we will say that our county's abundant water resources, which supply clean affordable water for industry and people, sustain our agriculture, forests, and wildlife, and give access to diverse

recreational opportunities will help to attract visitors and new residents to our pleasant county.

## BUSINESS

Historically, Westmoreland County prospered through a large industrial base that included coal and steel mills. Many of the factories and mills may have shut down in the 1980s, but the county continues to boast several large manufacturers and employers, and a great diversity of highly-skilled “small employers” scattered here and there in the county. Today, retail, healthcare, and manufacturing provide the largest number of jobs in the county.

This means the healthcare sector is currently the largest employment industry in Westmoreland County and is one of the county's largest opportunities for economic growth, which should continue to expand. Manufacturing has been declining for over a decade and the trend may continue, but it still provides nearly 9% of the county's jobs and 17% of all earnings. Access to abundant and sustainable water resources will continue to be a selling point for attracting industries to our county. A



Photo by Mark Jackson

*Residential street in Southwest Greensburg, PA.*

business hoping to locate here need not worry about a lack of water supply, and the protections our county affords to streams, wetlands, and floodplains will ensure that the business which chooses to locate here will be uninterrupted by water-related problems.

## HOUSING

The county includes 168,250 residential housing units, 80% of which are single family, and 60% of which are more than 45 years old. Of the older homes, most are located in cities, boroughs, or villages, giving a prime opportunity for people seeking walkable and sustainable communities. Many newer homes are suburban in location.

This means that much solid housing stock in good livable communities is available at a reasonable cost to people relocating to our county. Most of our homes have affordable public water and sewage, a coverage which is constantly increasing as our water and sewer authorities expand their service areas year by year. Many of our prime residential areas are quite close to water-based recreation activities such as boating, fishing, and swimming, thanks to our county park system, our state parks, and our rivers and streams. Properly planned new development, beyond the limits of our floodplains and designed in harmony with our natural resources, will encourage further in-migration to the county.

## TRANSPORTATION

Westmoreland has the second largest road system in the 10-county Southwest Planning Commission (SPC) region with 3,675 linear miles of roadway. The Pennsylvania Department of Transportation (PennDOT) maintains 1,185 miles, local municipalities maintain 2,409 miles, and the Pennsylvania Turnpike Commission is responsible for the remainder.

Aside from the interstates that traverse the county, US Route 30, PA Route 66, and US Route 22 are the county's busiest roadways, carrying up to 31,000 cars per day in some parts. Under PennDOT, the county currently has 80 roadway projects under the Transportation Improvement Program. New PennDOT projects are required to address stormwater management impacts.

This means PennDOT has protocols for managing stormwater during construction and improvement projects (there are four levels of projects, ranging from repaving to new construction) and projects must meet PA's National Pollution Discharge Elimination System (NPDES)



and Post Construction Stormwater Management (PCSM) requirements for water quality, stormwater management and erosion and sedimentation control during and after construction. The PA Turnpike also follows stormwater management requirements on new construction projects.

## PUBLIC SAFETY

The county adopted a Hazard Mitigation Plan in 2014 that coordinates safety and security projects among the Westmoreland County Departments of Public Safety, Planning, Public Works, GIS, and with Local Emergency Management, local municipalities, Pennsylvania Emergency Management Agency (PEMA), Westmoreland Conservation District, and Municipal Water Authority.

Over 9,000 county residents' homes lie within flood hazard areas within the county. New development and redevelopment are encouraged outside of flood hazard areas to reduce loss of life and property damage.

## UTILITIES

The county has multiple entities providing services for each of the utilities, including water, waste water management, electric, gas, phone,

and internet. Water and sewer services are publicly provided in some areas of the county and operated by over 50 separate providers.

Utility line construction does not typically involve stormwater management because the ground's surface is returned to the original condition – there's no new impervious surface. However, utility line construction can impact groundwater flow. It is to be expected that groundwater may be intercepted by a buried utility line; the groundwater flows along the outside of the line as if the line were a French drain. If utility lines are constructed in an area where groundwater may become a problem, it is important that their design include trench plugs to stop the migration of water, and drainage systems to relieve the water flow to a safe location.

Approximately 25% of property owners in the county rely on private water and waste water management systems. PA does not have regulations regarding the development of domestic systems, but protocols are available through PA DEP, PA DCNR, and other agencies.



*A view of an eastbound off-ramp at the improved Interstate 70 near New Stanton, PA*

Photo by Chris Droste



## Chapter 3. WESTMORELAND COUNTY WATER RESOURCES

### NATURAL WATER CYCLE

Our water resources are all tied together as part of the natural hydrologic or water cycle which begins when the rain falls. During the natural water cycle, some of the rain soaks into the ground to replenish our groundwater, some of it runs off the land to become the base flow in our streams and water bodies, and the rest sustains the vegetation and rises through the roots and leaves by evapotranspiration, to become rain again and complete the cycle.

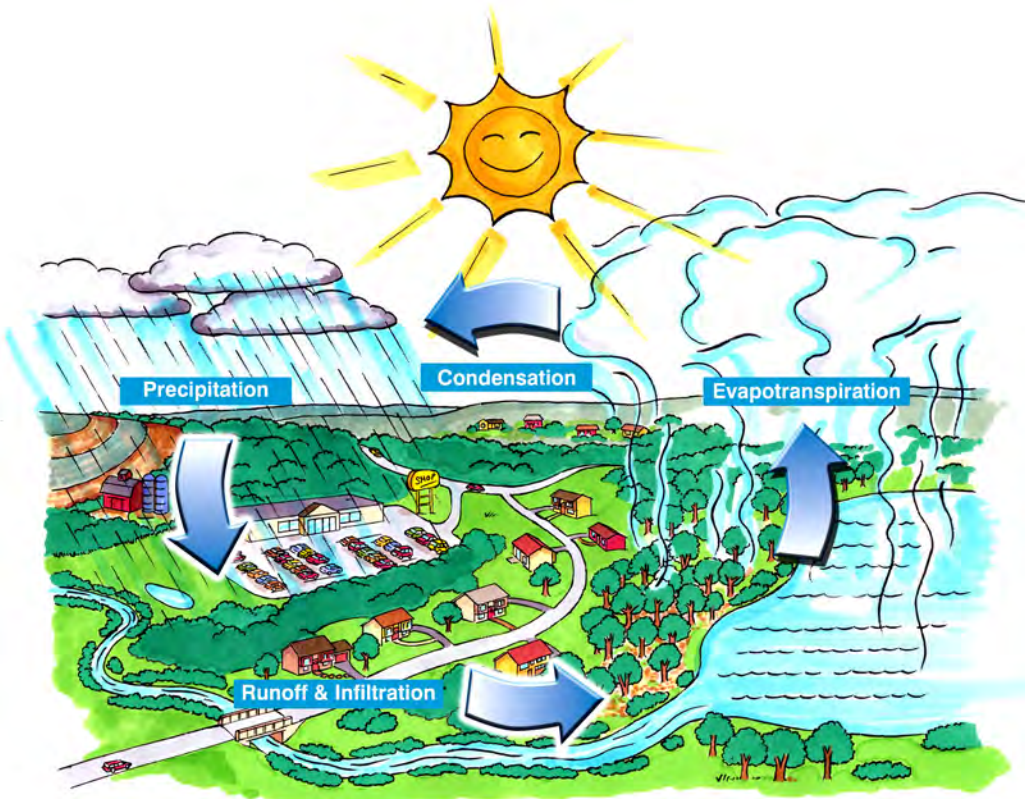

*The natural water cycle*

### WATER CYCLE AND DEVELOPMENT

The natural water cycle is affected by land development and changes in land use. Developed areas of our county can generate two to three times more stormwater runoff than undeveloped natural areas. In a rural or undeveloped condition half of the 40 inches of rain we receive

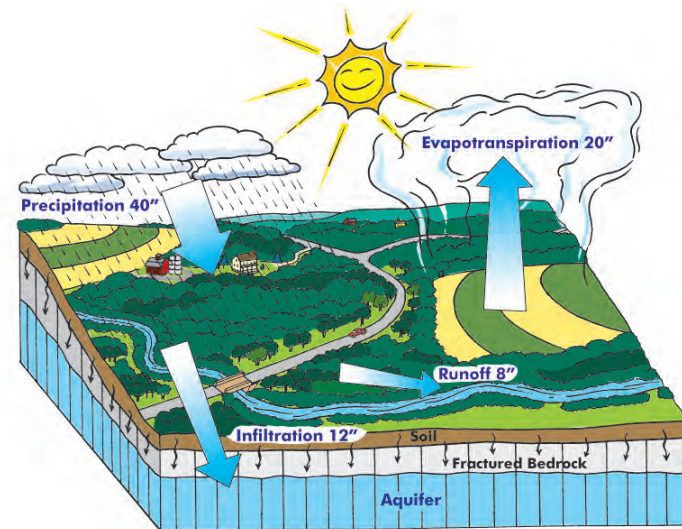

*Natural water cycle before development*

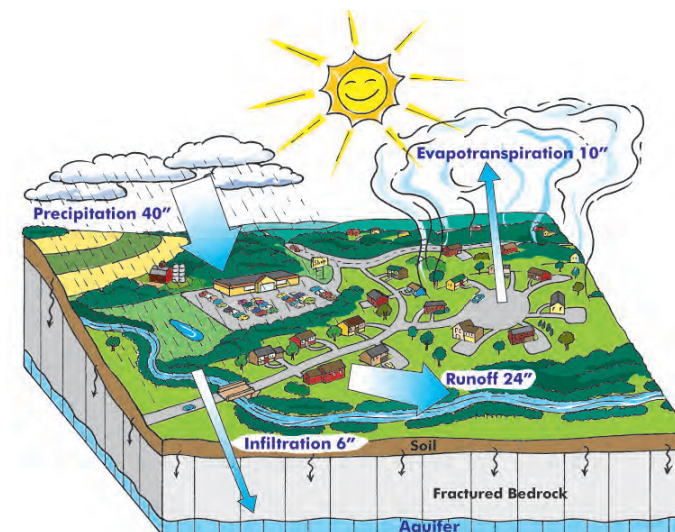

*The natural water cycle changes significantly with land development.*



is evapotranspired back into the air by the natural vegetation to complete the natural water cycle. Around 12 inches soaks into the ground through infiltration to replenish the natural water table and about 8 inches naturally runs off the land to become base flow in our waterways and waterbodies.

In a developed condition, where impervious areas like roofs, roads, and parking lots have been constructed covering the land, vegetation has been removed reducing evapotranspiration, and soils have been compacted reducing infiltration capacity, the natural infiltration rate can drop by 50% and the runoff rate can increase by 300%. The impacts that human activity and development have on the land create erosive flows in our waterways, encourage erosion and sedimentation, disrupt the natural water cycle, and impact the water resources that we depend on for a healthy environment.

Excess stormwater runoff is one of the key natural resource issues in our county, contributing to flooding, erosion, pollution, and property damage. Infiltration is also affected by land development and can be severely reduced by pavement, roofs, and soil compaction. Less infiltration means lower groundwater levels and less recharge of the base flow of streams. Water consumed in personal daily activities, manufacturing, and agriculture also can affect the balance of water in the county. The key to management of our water resources is to manage new and existing land development to closely replicate the natural water cycle to sustain this valuable resource.

## WATER BALANCE AND ALLOCATION

People rely on water resources for our drinking water supply, wastewater management, manufacturing, energy production, agriculture and food processing, as well as recreation and tourism. Those same resources must also be available for use by aquatic and riparian plants and animals. The potential for conflict among competing uses can be great. There also is uncertainty over how climate change will affect annual precipitation amounts and whether that may cause water shortages on a more frequent basis.

Although Westmoreland County does not have an official water budget, it is a worthwhile concept to consider for adoption in the future. A water budget accounts for the water inputs, outputs, and changes to the flow of water in a watershed. Some of these components are natural processes (precipitation, evapotranspiration, groundwater flow) and

some are created by humans (water withdrawals, interbasin transfers). By knowing where, when, and how much water flows in and out of the system, planners can determine how much water is left for other uses and where potential shortages may exist. (<https://water.usgs.gov/water-census/water-budgets.html>).

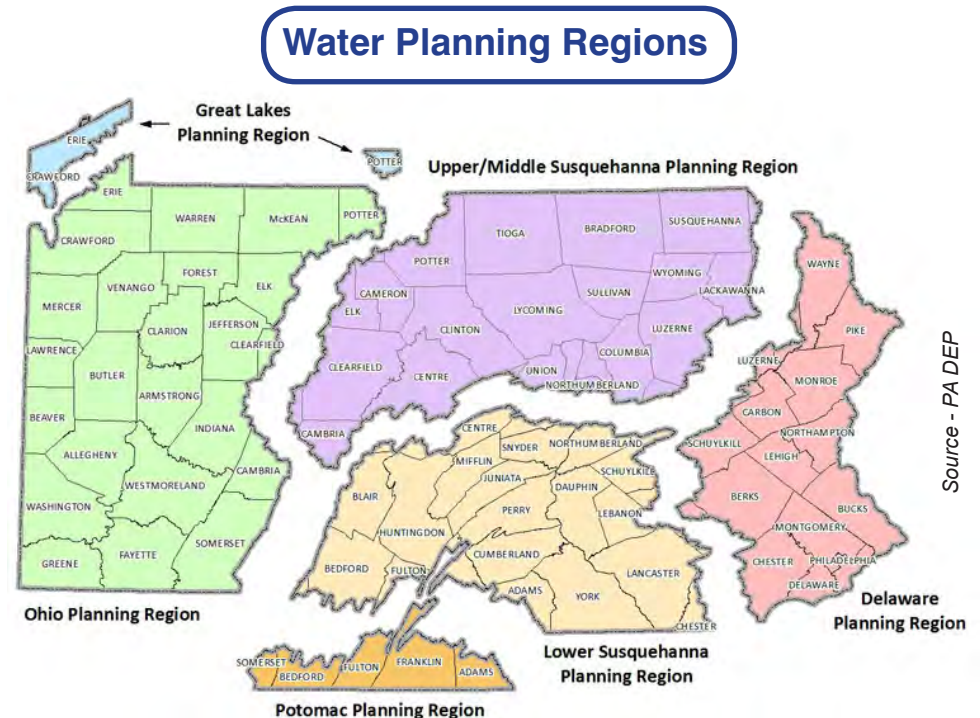

While the Pennsylvania Water Resources Planning Act 220 of 2002 uses watershed boundaries to evaluate water demands and needs, land development is still managed at a political level (townships, boroughs, cities, counties). These political subdivisions do not have the power to regulate water withdrawals or allocate water resources, which may result in conflicts. However, the State Water Plan makes its information available to municipalities to help make informed land use decisions (<https://extension.psu.edu/access-and-allocation-of-water-in-pennsylvania>), and has been included in the IWRP online decision making flowchart explained in Chapter 6: Action Plan.

Water resource use in Pennsylvania is governed by common law, which means that it is based on court rulings and legal precedent. This means that it can be changed or modified by any future court case. It also views surface water, diffuse surface water (runoff, snow

melt, floodwaters, seeps), and groundwater differently with separate and different rules ([http://files.dep.state.pa.us/Water/BSDW/Water-Allocation/water\\_law\\_review\\_022806.pdf](http://files.dep.state.pa.us/Water/BSDW/Water-Allocation/water_law_review_022806.pdf)).

While Act 220 recognizes the connection among surface, diffuse surface, and groundwater and provides guidelines for future allocation of that water, it is not known how it might affect future common-law interpretation (<https://extension.psu.edu/access-and-allocation-of-water-in-pennsylvania>).

## WATER RESOURCES

Our water resources include all water from precipitation to groundwater, and from streams and lakes to rivers and wetlands.

### PRECIPITATION

**Precipitation** is any product of the condensation of water vapor in the air that falls to the ground, including drizzle, rain, sleet, snow and hail. Westmoreland County receives on average about 40 inches of precipitation annually, increasing about five inches across the county from west to east.

**Why is this important?** On average, the continental U.S. gets about 30 inches per year, so we are wetter than many areas. This means we have enough water for commercial, industrial, agricultural, and personal use—but we sometimes have too much water, which leads to flooding.



Photo by Stephen Simpson

Road flooding near Champion, PA

## Rainstorm Intensity

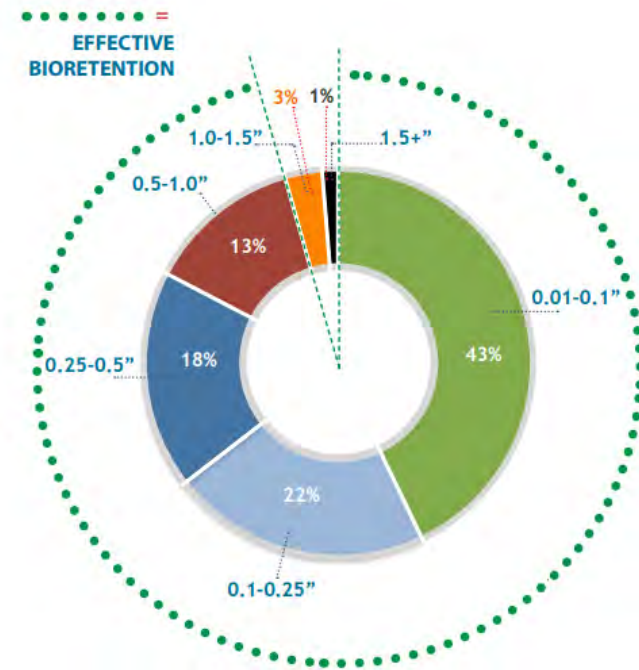

Precipitation Ranges (inches)	Average # Days per Year	Percent of RAIN Days per Year	Percent of Annual Precipitation
0.01 - 0.1	61	43%	7%
0.1 - 0.25	31	22%	13%
0.25 - 0.50	26	18%	24%
0.50 - 1.0	18	13%	31%
1.0 - 1.5	5	3%	13%
1.50+	2	1%	12%
	<b>143</b>	<b>100%</b>	<b>100%</b>

This graphic illustrates that the vast majority of precipitation we receive during a single rain event in southwestern Pennsylvania is well below 1 inch. In fact, 83% of all annual precipitation is ½ inch per day or less.



## WATERWAYS AND WATERBODIES

**A waterway or water body** is any body of water like a lake, pond, channel, or natural or man-made conveyance of surface water. It can be a run, stream, creek, or river that has defined bed and banks, whether natural or artificial, with a flow that is continuous or recurring.

There are approximately 2,000 miles of waterways in Westmoreland County and 8.5 square miles of water surface. Several lakes and dams in the county are under federal, state, or county control but many are privately owned. Class A wild trout streams account for 37 miles of waterways. **Impaired waters**, those classified by the state as having

some form of pollutant (often Abandoned Mine Drainage (AMD) but sometimes other pollutants), are 677 miles or 33% of the total stream miles in the county.

– *from the PA Fish and Boat Commission and the PA Water Plan*

**Why is this important?** Our water bodies, streams, and wetlands must be clean to be sustainable resources for all those who depend on and enjoy them.



Photo by Mark Jackson

*Fishing the Youghiogheny River near Smithton, PA*

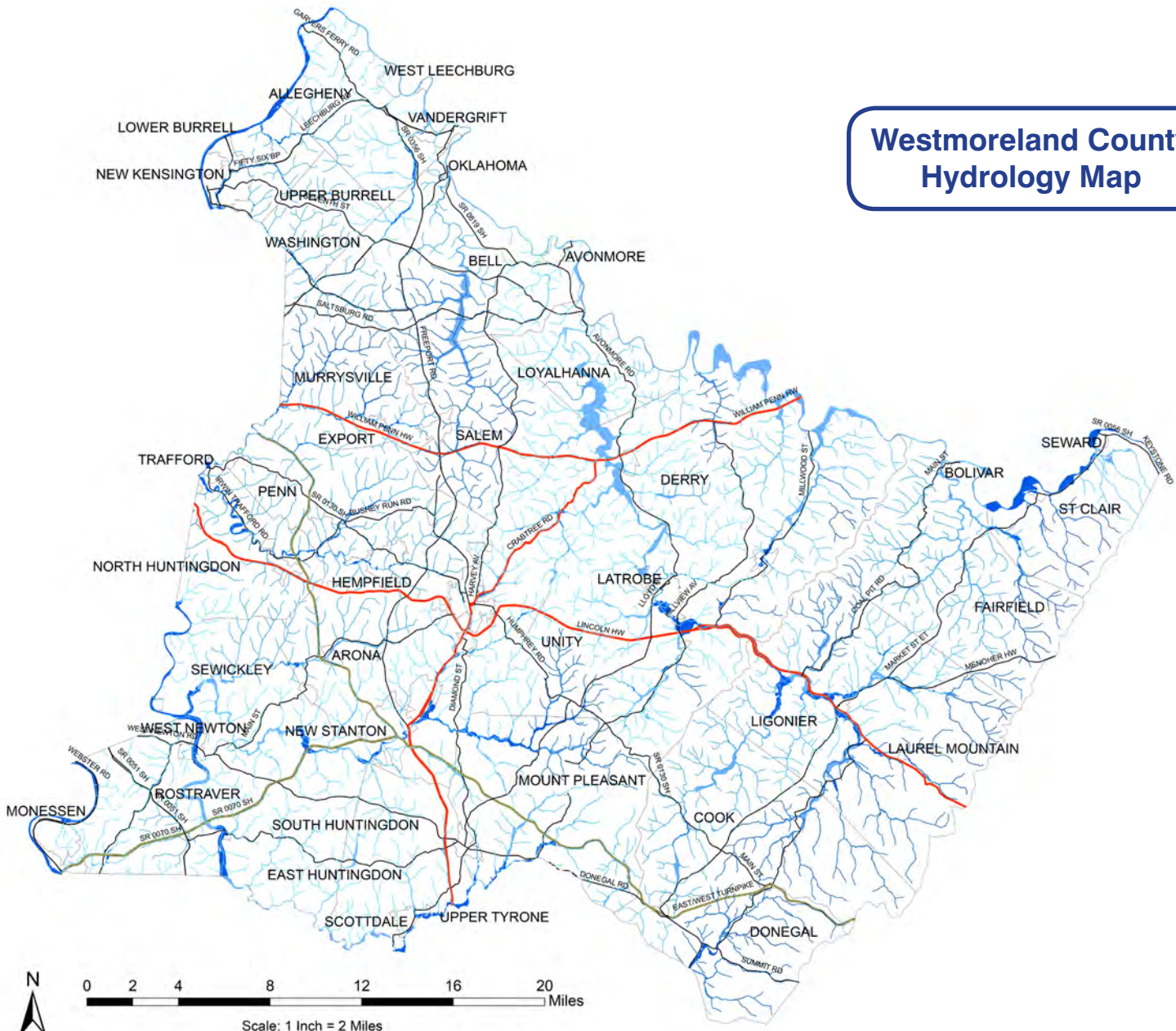

Photo by Mark Jackson

*Bridgeport Dam County Park*



# Westmoreland County Hydrology Map



- Legend**
- Chapter 93 Designated Use Streams**
- EV(EXCEPTIONAL VALUE)
  - HQ-CWF(HIGH QUALITY-COLD WATER FISHES)
  - HQ-TSF(HIGH QUALITY-TROUT STOCKING)
  - HQ-WWF(HIGH QUALITY-WARM WATER FISHES)
  - TSF(TROUT STOCKING)
  - CWF(COLD WATER FISHES)
  - WWF(WARM WATER FISHES)

- FEMA Floodplain Zones**
- 100 Year
  - 100 Year with Elevation
  - 500 Year

Source - PASDA



## WETLANDS

**Wetlands** are areas where water covers the soil or remains at or near the surface for an extended period of time throughout the year. These areas provide a hydrologic link between land and water resources, whether surface or groundwater. Wetlands differ from each other in topography, climate, hydrology, water chemistry and vegetation and they provide unique habitat to many species of plants and animals. Wetlands also serve as natural filters to surface and groundwater supplies. As water flows through a wetland, contaminants like nitrates, phosphates, and sediment particles are captured and removed by nearby vegetation, thereby eliminating them from the water.

“The county has approximately 2,200 acres of wetlands, which equates to about 0.5% of the total land area, yet they are valuable wildlife habitat and home to many endangered species. Most of the designated wetlands are located in the northeastern portion of the county, branching off of Loyalhanna Creek and in the southern portion, branching off of Jacobs Creek. The Sewickley Creek Wetlands, located in the center of the county, are used as an education space with an observation deck and trails for visitors to learn about wetlands habitat.”

– *Reimagining Our Westmoreland*



Photo by Kathy Hamilton

*PennDOT's Jacobs Creek wetland bank in Mount Pleasant PA*

## GROUNDWATER

**Groundwater** is the water present beneath Earth's surface in soil pore spaces and in the fractures of rock formations. Groundwater supplies are affected by the geology of the region depending on the concentration of fractures and cracks in the bedrock. Coal fields, which are typically cracked and fractured, also have an effect on groundwater allowing for better transportation of groundwater through its conduits. Past and present mining practices however, have impacted and diverted groundwater movement.

The geology of Westmoreland County is such that there is no one single water table, but many local water tables and at varying elevations. Westmoreland County consists mostly of interbedded sedimentary rock with some sandstone along the ridges. Layers of coal are also typically found underground, along with natural gas.

***Why is this important?*** Wells drilled for water use in our geologic regime often have low yields and produce water high in iron, sulfur, and other minerals. This limits growth in areas where there is no access to city water.



Photo by Kathy Hamilton

*Well casing*





Photo by Stephen Simpson

*Heron on Loyalhanna Creek*

## WATERSHEDS

A **watershed** is a drainage basin or area of land where precipitation collects and drains off into a common outlet, such as into a waterway, or other body of water. The drainage basin includes all the surface water from rain runoff, snowmelt, and nearby streams that runs downslope towards the shared outlet, as well as the groundwater underneath the Earth's surface.

Westmoreland County has 10 major watersheds. Sewickley Creek and Loyalhanna Creek are the only two located solely within the county. The Kiskiminetas and Conemaugh River basins are shared with Cambria, Indiana and Armstrong counties; Indian Creek with Somerset and Fayette counties; Jacobs Creek and Youghiogheny River with Fayette; Monongehela with Fayette and Washington; and Turtle Creek, Pucketa Creek-Plum Creek-and the Allegheny River with Allegheny County. For a detailed look into these watersheds refer to Chapter 5. Issues and Challenges.

Many watersheds in Westmoreland County have watershed associations which provide stewardship for the waterways, **habitats, and ecosystems**

within their watershed. These watershed associations have created watershed and river conservation plans and are very active in education and restoration programs and projects in their watersheds. Our watershed associations include:

- Kiski-Conemaugh Watershed Association
- Pucketa-Chartiers Watershed Association
- Loyalhanna Watershed Association
- Mountain Watershed Association (Indian Creek)
- Sewickley Creek Watershed Association
- Jacobs Creek Watershed Association
- Turtle Creek Watershed Association

For a full list of watershed plans, refer to the Appendix.



**Legend**

Westmoreland Municipalities

**FEMA Floodplain Zones**

- 100 Year
- 100 Year w/Elevation
- 500 Year

**Westmoreland County  
Floodplains**



City of Latrobe FEMA designated 100 year floodplain  
Image - Westmoreland County GIS

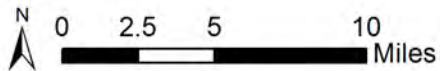
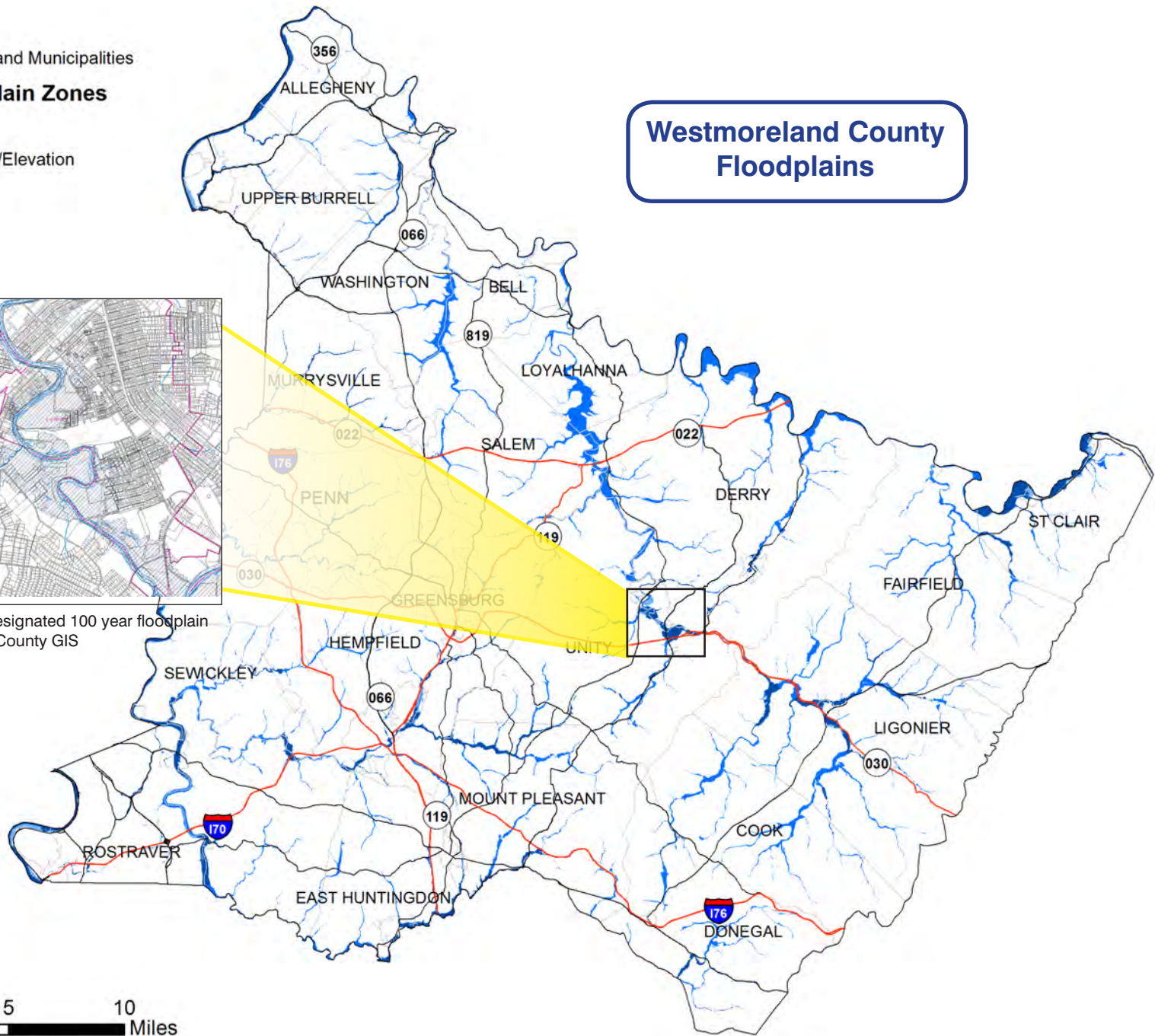

Source - Westmoreland County

## FLOODPLAINS

**Floodplains** are the relatively flat areas adjacent to streams and water bodies that become inundated with water when the banks or channel capacity is exceeded during heavy rain events. When flooding occurs naturally, floodwaters carry nutrient rich sediments that can be deposited on floodplains to encourage a fertile environment for vegetation and habitat for wildlife.

Many of the waterways in Westmoreland County have floodplains identified and delineated by the Federal Emergency Management Agency (FEMA). Years of development have encroached on many of the natural floodplains and have affected those living within the designated floodplain. Even without this designation, many county residents experience roadway flooding, property flooding, and flood damage in low lying areas and along waterways where there is development and inadequate infrastructure.

**Why is this important?** Floodplains are beneficial by controlling floodwaters, allowing sediment to deposit on the floodplain and breaking down pollutants. Future development ought to be located outside of floodplains. Existing homes and businesses in floodplains would benefit from flood control measures, whether on-site or on a watershed-wide basis.



Photo by Kathy Hamilton

Flash flood at a home in Salem Township

## REGULATIONS

Water is regulated on the federal, state, and local level. The primary federal law governing stormwater runoff is the **Clean Water Act of 1972** - 33 U.S.C. §1251 et seq. (1972)

**The Clean Water Act (CWA)** regulates the discharge of pollutants into US waters, and sets the quality standards for surface waters. The basis of the CWA was enacted in 1948 and was called the Federal Water Pollution Control Act, but the Act was significantly reorganized and expanded in 1972. "Clean Water Act" became the Act's common name with amendments in 1972.

The CWA made it unlawful to discharge any pollutant from a point source into navigable waters, unless a permit was obtained. EPA's National Pollutant Discharge Elimination System (NPDES) permit program controls discharges. Point sources are discrete conveyances such as pipes or man-made ditches.

The NPDES permit program, created in 1972 by the CWA, helps address water pollution by regulating point sources that discharge pollutants to waters of the United States. The permit provides two levels of control: technology-based limits and water quality-based limits (if technology-based limits are not sufficient to provide protection of the water body).

Under the CWA, EPA authorizes the NPDES permit program to state governments, enabling them to perform many of the permitting, administrative, and enforcement aspects of the NPDES program.

**Pennsylvania's Clean Streams Law**, originally enacted in 1937, is our state's basis for water regulations. The law preceded Pennsylvania's Stormwater Management Act (better known as Act 167), Chapter 102 (Erosion and Sediment Control Requirements), and NPDES Permit Program for Stormwater Discharges Associated with Construction Activities, Chapter 105 (stream encroachment requirements), and the MS4 Program for municipalities with separate storm sewer systems. These programs are amongst the Commonwealth's methods for meeting the runoff-related requirements of the federal CWA.

Passed in 1978, the Commonwealth of **PA's Stormwater Management Act 167** mandates that every Pennsylvania county must study stormwater issues and create a stormwater management plan. This IWRP will meet those mandates. In September 2002, in an attempt to integrate its various stormwater management programs (including MS4



Permits, NPDES Construction Permits, and Act 167) and promote a comprehensive watershed approach to stormwater management, PA DEP finalized a Comprehensive Stormwater Management Policy, DEP Policy No. 392-0300-002.

**PA Code Chapter 102** of the PA Code Title 25 requires persons proposing or conducting earth disturbance activities to develop, implement and maintain best management practices (BMPs) to minimize the potential for accelerated erosion and sedimentation and to manage post construction stormwater. The BMPs shall be undertaken to protect, maintain, reclaim, and restore water quality and the existing and designated uses of waters of the Commonwealth. For most earth disturbances greater than 1 acre, a NPDES permit is required and measures must be taken to manage the increase in stormwater runoff with a Post Construction Stormwater Management (PCSM) plan.

The PA DEP issued the latest version of the Erosion and Sedimentation Pollution Control Manual in March 2012 to help guide the implementation of controls for earth disturbance.

The **NPDES** permit applies to most earth disturbance activities that disturb greater than or equal to 1 acre of earth disturbance. This permit does not apply to agricultural plowing and tilling, animal heavy use areas, timber harvesting activities, road maintenance activities, and oil and gas activities. The major components of an NPDES Permit Application include: Erosion and Sediment (E&S) Control Plan, Pennsylvania Natural Heritage Program (PNHP) Search, Post Construction Stormwater Management (PCSM) Plan for all storms equal to or less than the two year/24-hour event, Thermal Impact Analysis, and Anti-degradation Analysis to ensure the development does not increase the post-development total runoff volume.



Photo by Chris Droste

*Erosion control barriers prevent sediment-laden water from leaving construction sites under Chapter 102.*



The **PA Stormwater Best Management Practices Manual** (Manual) was released in December 2006 to assist with the implementation of PA DEP's 2002 Stormwater Management Policy. The stated goal of the Manual is "to protect, maintain, and improve the Commonwealth's water resources, while allowing for the continued growth and development of Pennsylvania." The Manual describes a stormwater management approach to land development that:

- Emphasizes reducing the impacts of development activities through planning and development techniques that avoid potential impacts to watershed resources; and
- Minimizes and mitigates any unavoidable impacts through the use of both structural and non-structural best management practices

The manual is used to complete the NPDES and PCSM permit applications.

**PA Code Chapter 105** of the PA Code Title 25 regulates structures and activities under Section 302 of the Pennsylvania Flood Plain Management Act.

The purposes of this chapter are to:

- Provide for the comprehensive regulation and supervision of dams, reservoirs, water obstructions and encroachments in the Commonwealth in order to protect the health, safety, welfare and property of the people
- Assure proper planning, design, construction, maintenance,

monitoring and supervision of dams and reservoirs, including preventive measures necessary to provide an adequate margin of safety

- Assure proper planning, design, construction, maintenance and monitoring of water obstructions and encroachments, in order to prevent unreasonable interference with water flow and to protect navigation
- Protect the natural resources, environmental rights and values secured by the Pennsylvania Constitution and conserve and protect the water quality, natural regime and carrying capacity of water courses

**A PA DEP Chapter 105 General Permit (GP)** for stream encroachments may be required if the project impacts streams, water bodies and/or wetlands. Some permits are required for projects with a contributory drainage area greater than 100 acres. Projects with a contributory drainage area greater than 1 square mile may instead require a Joint Permit issued by PA DEP.

General Permits that are available related to land development include:

- Fish Enhancement Structures
- Private Recreational Docks
- Bank Rehabilitation, Protection, and Gravel Bar Removal, (limit 500 linear feet)



Photos by Rob Cronauer

*Before and after photos of a Bank Rehabilitation General Permit project along Mill Creek*



- Intake and Outfall Structures
- Utility Line Stream Crossings
- Agricultural Crossings and Ramps
- Minor Road Crossings (limit 1 square mile of drainage)
- Temporary Road Crossings
- Agricultural Activities
- Abandoned Mine Reclamation
- Maintenance, Repair, Rehab or Replacement of Water Obstructions and Encroachments

## MS4 COMMUNITIES

In Westmoreland County, 35 of our 65 communities are classified as Municipal Separate Storm Sewer System (MS4) communities, which means they are part of an urban area; have a certain population density; and have storm sewer systems separate from sanitary. MS4



Photo by Mark Jackson

*Westmoreland Conservation District Watershed Program Manager Rob Cronauer checks developing trees which are part of a stream buffer at Hutter's Dairy Farm near Kecksburg. A cattle stream crossing is in the background.*

communities are required by the State to address **six minimum control measures** for improving stormwater quality: public education and outreach; public participation; illicit discharge detection and elimination; erosion and sedimentation control; post-construction stormwater management in new and re-development; and good housekeeping for pollution prevention in municipal facilities.

The municipalities are also required to create a **Pollution Reduction Plan** (PRP) to implement control measures for pollutant reduction in storm sewer discharges. The IWRP provides guidance for communities to meet these requirements and help them establish a municipal stormwater ordinance to address key community issues in perpetuity, as well as identify potential projects to meet pollutant reduction plan requirements set by PA DEP.

Many municipalities across the county have their own stormwater management regulations, but some have none. The IWRP provides guidance to municipalities on managing water resources and on partnering with other municipalities that share watersheds and stormwater issues. It also recommends a model stormwater ordinance to help those municipalities guide development and address issues related to stormwater management, especially those communities without a current stormwater management ordinance. The county's **Model Stormwater Management Ordinance** is located in the Appendix.

"Of the 65 municipalities in Westmoreland County, 35 municipalities have a municipal comprehensive plan to guide development into the future and 46 municipalities have a zoning ordinance or SALDO of their own to regulate land use. The remaining 19 follow County SALDO regulations. Only 24 of the 65 currently have a stormwater management ordinance to provide guidance and regulation for managing stormwater in their own communities." – *Reimagining Our Westmoreland*

The **Westmoreland Conservation District** is mandated by PA DEP to administer, monitor and provide technical assistance for the programs developed by the state to meet the CWA, the PA Clean Streams Law, Act 167, Chapter 102 including the NPDES permit program, and Chapter 105. The District also provides technical assistance to municipalities with their MS4 requirements. Most individual municipalities across the county have developed their own regulations for land development and stormwater management or they are covered by the county's Subdivision and Land Development Ordinance (SALDO).

# Legend

Westmoreland Municipalities

## MS4

### PERMIT STATUS

- General
- Individual
- Waiver

# Westmoreland County MS-4 Permit Status

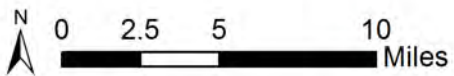
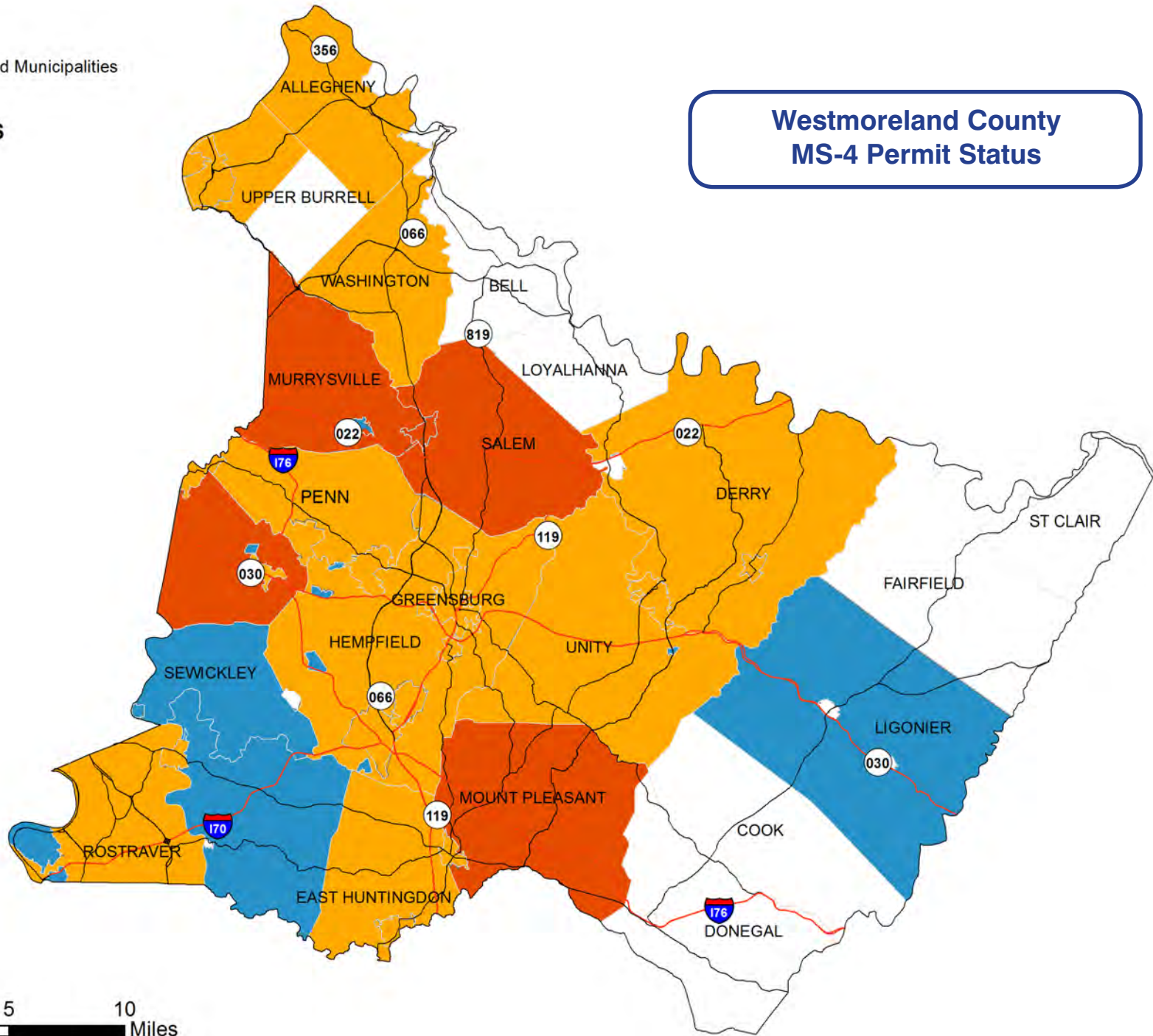



# Westmoreland County SALDO and Zoning

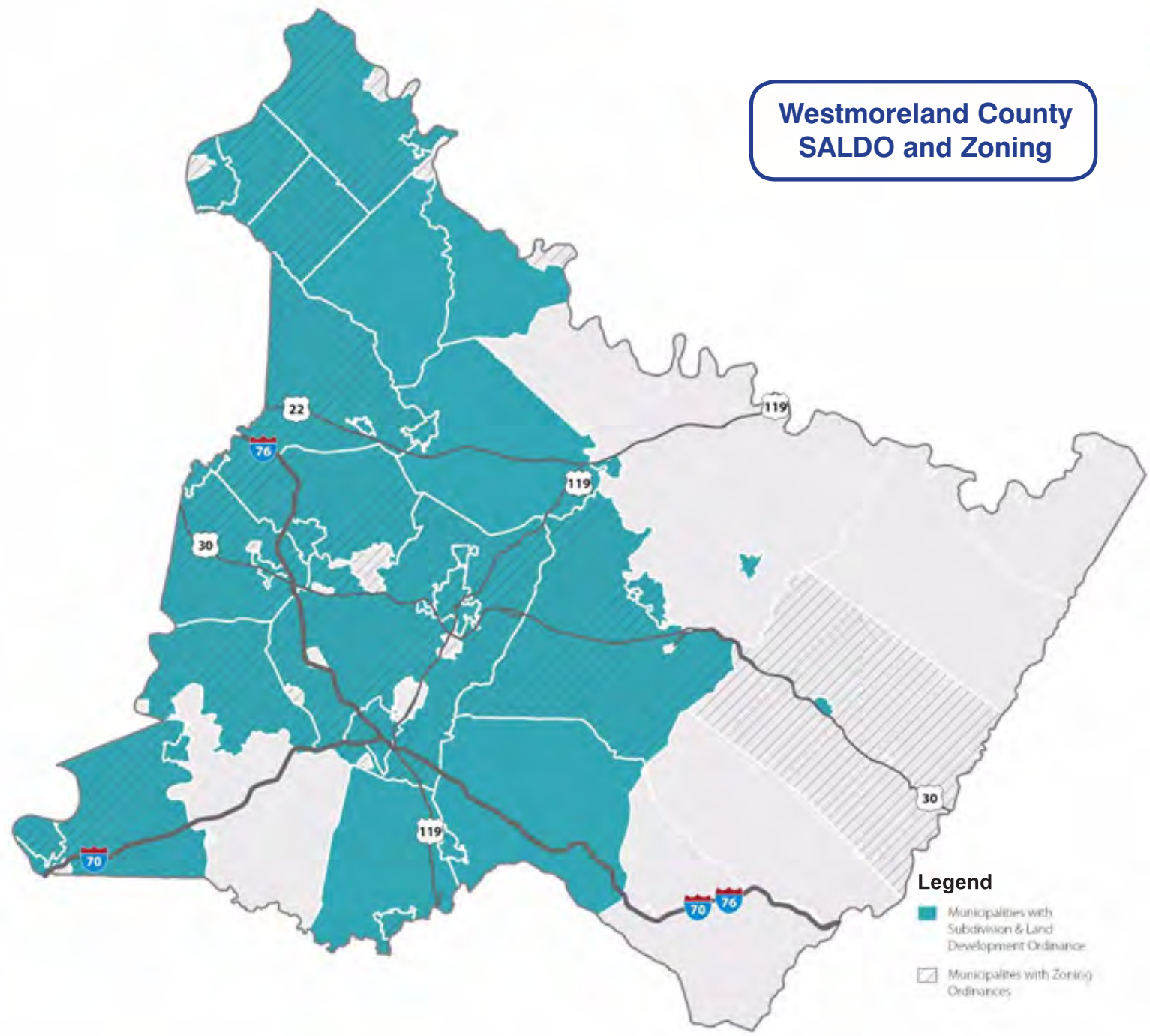

Source - Westmoreland County Planning (2018)

## Chapter 4. **IMPACTS**

*“Population, land use, development and redevelopment all impact our water resources. Water use, alteration and removal of natural features, and the resulting polluted runoff affect both the quantity and quality of water resources. Failure to properly plan development can create conflicts, increase costs, and diminish the quality and sustainability of our water resources.” – State Water Plan*

### **WESTMORELAND COUNTY COMPREHENSIVE PLAN**

In 2016 Westmoreland County embarked on a new Comprehensive Plan “Reimagining Our Westmoreland”. It will be a community driven road map detailing a long term vision and policy agenda for important quality of life issues like land use, housing, parks, infrastructure, transportation and more.

*“Water touches all areas of life in Westmoreland County, drinking water to waste water treatment to recreation and industrial/commercial use; therefore the study of our water resources must also include stormwater and the water related issues of water use, flooding, and pollution.”*

*-From Reimagining our Westmoreland, the County Comprehensive Plan*



Photo by Westmoreland County

*Ann Rudd Saxman Nature Park is a open space in the middle of a highly developed area near Greensburg.*



## GROWTH TRENDS AND WATER

According to “Reimagining Our Westmoreland”, development of housing, business, and industry has been shifting from downtown and already-developed areas to rural areas and suburban corridors, due in part to the following:

- Availability of large parcels of land
- Higher cost of demolishing and/or rehabilitating exiting structures as opposed to new construction on greenfield sites
- Consumer demand for easy-to-access sites that are close to major roadways and have plentiful parking

These development trends (many label them as ‘sprawl’) impact county water resources. One acre of parking lot can generate 27,225 gallons of runoff water in a one-inch rainstorm; this happens day or

night, whether or not anyone is parked in the lot. Researchers at the University of California-Berkeley found that there are about 3.4 parking spaces available per car, nationwide. This means in our county, with approximately 250,000 personal vehicles registered, there may be as many as 850,000 parking spaces, all generating runoff in rainstorms and contributing pollutants such as oil, fluids, metals, and sediment to our waterways.

Our county’s system of roadways can be looked at the same way. If we assume that each of our county’s approximately 4,700 lane-miles of road are ten feet wide, this equals a paved area of 5,697 acres, or about 8.9 square miles. During a one-inch rainstorm, our roadways can generate 155 million gallons of runoff into our streams and waterbodies.



Photo by Pictometry

East Huntingdon Township: Commercial development along a transportation corridor. Notice the impervious coverage.

## Legend

Westmoreland Municipalities

## 1985 Impervious Cover

High : 100  
Low : 0



## Impervious Cover 1985

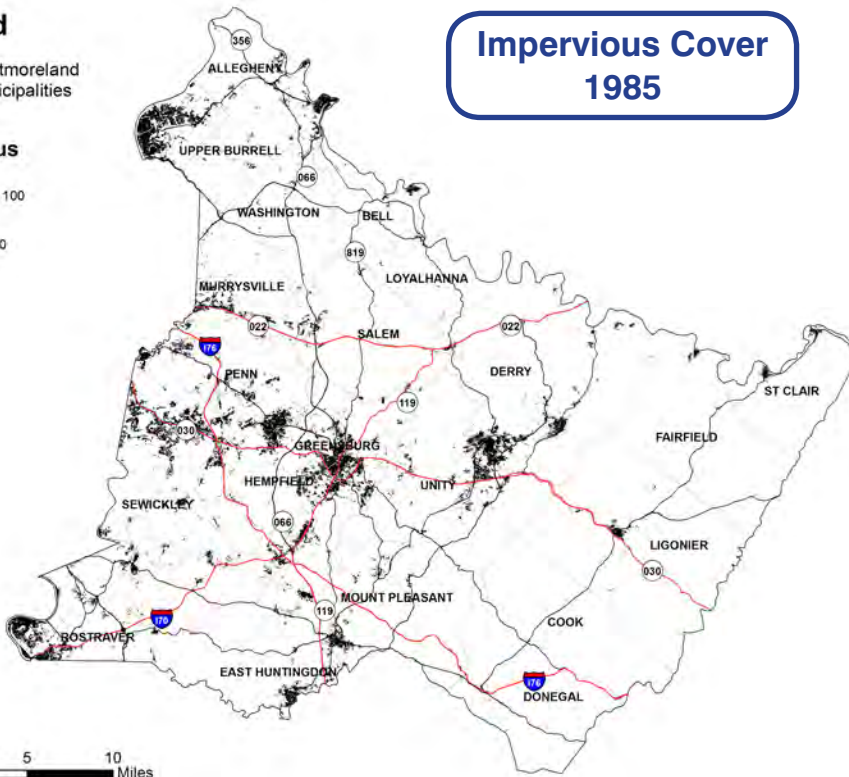

## Legend

Westmoreland Municipalities

## 2000 Impervious Cover

High : 100  
Low : 0



## Impervious Cover 2000

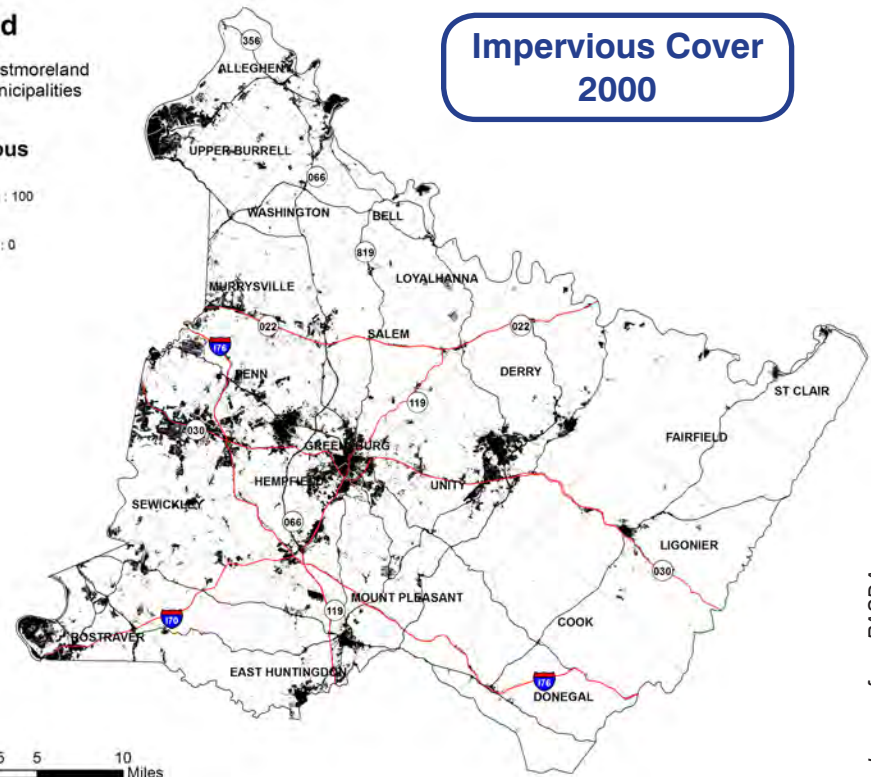

Images from PASDA

Runoff carrying pollutants from roads and parking lots is only one water-related issue facing our county. Our desire is that informed Westmoreland County citizens studying “Reimagining Our Westmoreland” and the Integrated Water Resources Plan will guide future development and redevelopment to reduce future impacts and even correct past impacts from unmanaged development, and promote sustainability in the county.

The following maps showing impervious cover across the county illustrate the concept of ‘sprawl’ or, the spreading of developed areas beyond what would historically have been necessary to support a certain population. Notice the change in impervious area from 1985 to 2000; the trend is sure to continue unless societal expectations change.

## PHASE 1 ACT 167 PLAN

Phase 1 of the Act 167 Plan identified impacts to our water resources by referring to the PA Chapter 93 stream classifications for impaired waterways and their impairments, by noting existing dams and impoundments, and by tallying reported stormwater issues across the county.

During preparation of Phase 2 of the Act 167 Plan and the IWRP, the list of impacts to water resources grew to include water use by people including water supply and waste water treatment, flood hazard areas, obstructions, hydromodifications, impacts from resource extraction (oil & gas, coal and abandoned mine lands), and more.

Learn more in the appendix for an excerpt of the Act 167 Phase 1 report or go to [http://spcwater.org/pdf/acts/WestmorelandCounty/WestmorelandCounty\\_Phase1\\_Act167.pdf](http://spcwater.org/pdf/acts/WestmorelandCounty/WestmorelandCounty_Phase1_Act167.pdf)



## WATER USE

Water is used many different ways, including power generation, public water supply, industries, aquaculture, irrigation, livestock, mining, and firefighting. Without good clean water, our county would grind to a halt. And without our region's plentiful water, our cost of living would be higher, and our difficulty of living would increase. Anyone who has traveled to a place where "you can't drink the water" will understand, or as Ben Franklin said, "You won't know the worth of water until the well is dry." Much of the population in Westmoreland County is served with drinking water by various public sources. Most public water is from surface sources – rivers and creeks. In more rural areas, people rely on wells or springs to supply their homes with water.

There are two types of water use: consumptive use and withdrawal. Consumptive use is water which is removed from a watershed, making it unavailable for other uses. Consumptive uses include water used in the evapotranspiration process by growing plants, water used for bottling drinking products for sale in another region, and water evaporated

by a power plant's cooling tower. Withdrawal is water which is taken from a source for a particular use. Withdrawal can be water piped from a stream to fill a fish pond and water taken from a river for drinking water which subsequently returns to the river through sewage treatment facilities.

In the Ohio River basin, consumptive use is dominated by water used in coal-fired power plants or thermoelectric use as shown in the following chart. The recently-opened Tenaska natural gas fired power plant in South Huntingdon Township will require nine million gallons of water daily for its operation, placing it into the 'thermoelectric' category of water use. Industry and public water supply, which are mostly withdrawals, are dominant in the Ohio River basin. In the Westmoreland water use chart, public water supply dominates. Domestic Water Supply on the chart refers to private sources like wells, and spring. Aquaculture primarily refers to fresh water where fish are stocked in a designated stream or lake.

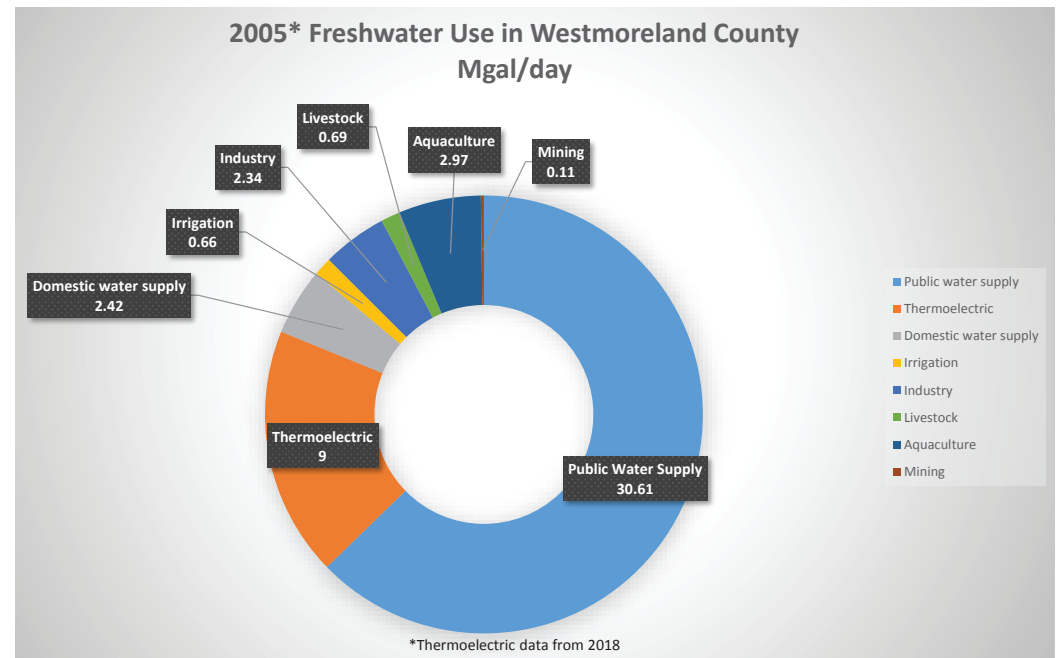
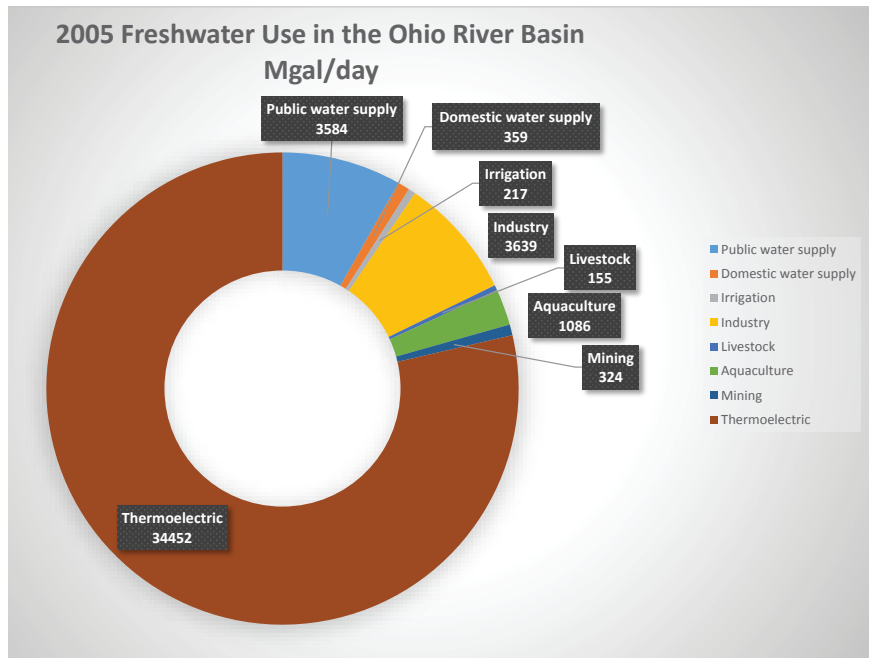

## RECREATION AND WATER USE

The chart of water use in Westmoreland County doesn't specifically show recreation. Recreation includes designated water trails and access ramps to waterways and lakes for boating, fishing, swimming, and more. Many residents and visitors alike enjoy Westmoreland County's water resources.

The Army Corps of Engineers (ACOE) maintains the Loyalhanna Lake and Conemaugh Lake recreation areas for boating, fishing, hiking, and passive recreational activities. There are four state parks in Westmoreland County: Keystone which has a lake for fishing, boating and swimming; Linn Run which is a trout fishery; Laurel Ridge; and Laurel Summit. Forbes State Forest lies along Laurel Ridge at the eastern border of the county and protects the headwaters of several high quality and exceptional value streams; the unusual Spruce Flats Bog is found here too. Recreational boating and fishing also occurs on the Allegheny,

Monongahela and Youghiogheny Rivers, which are accessible via boat ramps at various locations in the county.

Water trails are boat routes suitable for canoes, kayaks, and small motorized watercrafts. Like conventional trails, water trails are recreational corridors between specific locations, and are comprised of access points, boat launches, day use sites, and in some cases overnight camping areas. Each water trail is unique; a reflection of Pennsylvania's diverse geology, ecology and communities. In Westmoreland County, water trails are found on the Youghiogheny River, Loyalhanna Creek, Kiski-Conemaugh River, and Sewickley Creek.

**Why is this important?** Westmoreland County parks, open space, water bodies and waterways provide close-to-home recreation. Outdoor recreation like fishing and boating supports and contributes to a high quality of life for the residents of Westmoreland County and it attracts employers and families.

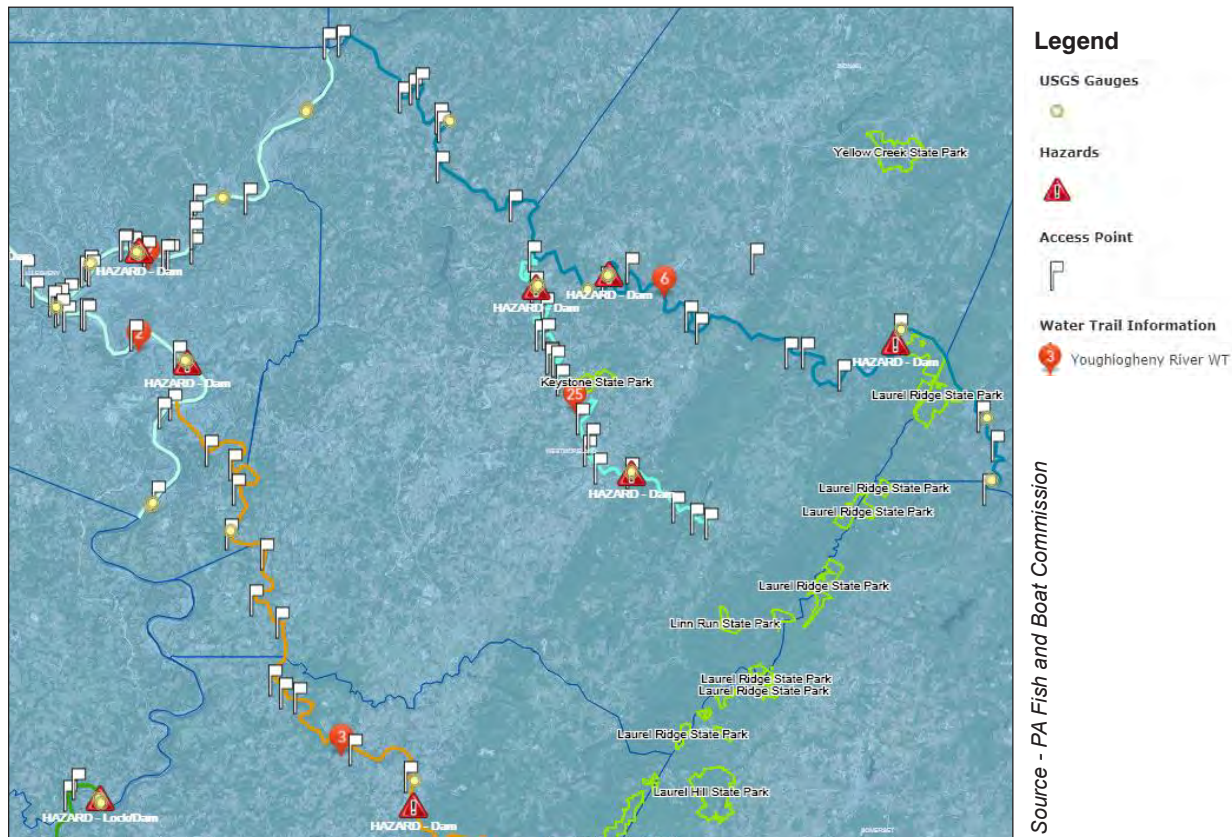

Water trails and access points in Westmoreland County



Fishing class on Loyalhanna Creek

Photo by Mark Jackson



## AGRICULTURE / AQUACULTURE AND WATER USE

**Agriculture** activities comprise 20% of Westmoreland County's land use. Locally sourced agricultural products such as grass-fed beef or organically grown vegetables command a prime price in local farmers markets. Availability of such locally-sourced products is one key factor in our quality of life and in attracting new residents to our county.

Many of the fresh fruits and vegetables found in our supermarkets, however, come in from all across the world. Farmland in places like Arizona or California must be irrigated to produce crops. Here in Westmoreland County, irrigation for field crops has historically been not necessary due to our abundant rainfall. However, some specialty crops such as vegetables are irrigated. Since agricultural operations use much water in their daily operations for crop production and sustaining livestock, agricultural use of water should be considered in any water plan.

**Why is this important?** Sustaining and growing the county's agricultural economy relies on the availability of clean water. Dairy cows can easily drink up to 50 gallons of water per day. Other livestock, like cattle, horses, pigs, and chickens all have to have a certain amount of fresh, clean water every day. That demand for water can become

expensive if the farmer has to pay for the water. However, Westmoreland County is blessed with an abundance of natural springs where water seeps or flows out of the ground. A typical practice to enable farmers to water their livestock is to "develop" a spring and direct it to water troughs. To develop it simply means to carefully dig back into the hillside, find the source of the water, put in a gathering box under the ground, and lay a pipe to the water trough. The water will continually flow through the trough, which keeps it from freezing in the winter.

Water for agricultural irrigation is becoming much more important in Westmoreland County. There are a number of vegetable growers who supply local markets and consumers with quality vegetables from their farms and high tunnels (temporary plastic hoop greenhouses). Irrigation takes a tremendous amount of water – perhaps 20 inches of additional water on top of our regular rainfall, depending on the crop and whether there is a roof over the plants. It is estimated that there are over one thousand acres in the county that are now being irrigated, and this acreage will probably continue to increase because of market demand. Irrigation water is usually from surface sources, such as lakes, ponds, and streams because pumping that much water from below the ground surface is cost prohibitive.



Photo by Mark Jackson

*Spring development for cows*



Photo by Mark Jackson

*Derry Township farmers Mike and Ina Bazley grow vegetables in a high tunnel and sell them at farmers markets.*

**Aquaculture** is the raising of aquatic animals, the cultivation of aquatic plants for food, and the enhancement of production, such as regular stocking, feeding, and protection from predators. The 2012 USDA census of aquaculture lists Mammoth Park and its 24-acre fresh water lake as “stocked” by the PA Fish and Boat Commission (PFBC).

The goal of the PFBC since the late 1800s, is to promote high-quality streams, clean water, and good habitat, so that residents and visitors alike can enjoy recreational fishing and boating. The founding of the PFBC came about as a result of the noticeable impact of sediment from large-scale clearcut logging; a negative impact on our Commonwealth’s streams so severe that the legislature in 1866 created the position of Commissioner of Fisheries. The PFBC annually stocks streams and lakes in Pennsylvania with cold water, warm water and cool water species throughout the year and maintains hatcheries.

In recent years the mission of the PFBC has expanded to include protection of endangered species, as the agency is one part of Pennsylvania’s Natural Heritage Partnership, which curates the Pennsylvania Natural Diversity Inventory (PNDI), a statewide searchable index of endangered plants, animals, fish, amphibians, and invertebrates. Protecting these endangered species, many of which have a natural aquatic habitat and a water-dependent life cycle, helps to preserve our environment and the great diversity of life found in our state. Most persons obtaining a state permit for water-related construction activities (for example, a bridge across a stream) must use the PNDI search to discover possible impacts of their project on endangered species.

**PA Fish and Boat Commission  
2018 Statewide Summary of Trout Stocking**

2018 Summary of Planned Adult Trout Stocking*						
Water	Number	Brook	Brown	Rainbow	Total	Trophy**
Streams	715	378,730	609,970	1,546,000	2,534,700	7,263
Lakes	126	93,940	31,880	498,880	624,700	1,320
Combined	841	472,670	641,850	2,044,880	3,159,400	8,583
<i>Cooperative Nurseries (approximately)</i>					1,241,927	
<b>Total to be Stocked</b>					<b>4,401,327</b>	

**Westmoreland’s Trout Stocked Lakes - open year round**

- Keystone Lake
- Northmoreland Lake
- Twin Lakes Number One Reservoir (Lower Twin Lake)
- Twin Lakes Number Two Reservoir (Upper Twin Lake)



*Fishing Derby at Mammoth Park lake – Westmoreland County Parks*

**Other Trout Stocked Lakes**

- Mammoth Lake
- Indian Lake, North Huntingdon Township

**Westmoreland’s Trout Stocked Streams**

- Turtle Creek
- Sewickley Creek
- Fourmile Run
- Mill Creek
- Hendricks Creek
- Shannon Run
- Long Run
- Jacobs Creek
- Linn Run
- Hannas Run
- Tubmill Creek
- Loyalhanna Creek



**Why is this important?** Fishing is one of the oldest and most common recreational activities in our county. Visit one of our county parks on a pleasant day and you will see the shorelines of the lakes lined with people fishing. Fishermen (and women and children) enjoy being outdoors and having a quiet place for recreation and communing with nature. In 2015 in PA, over 1.4 million people purchased some kind of fishing license and in Westmoreland County the figure was just over

38,000. Recently our county's ten-year average of boating registrations was over 10,000 out of over 328,000 statewide. These show that over ten percent of our county's citizens enjoy these pastimes, not an insignificant number! Preservation of our current good-quality streams and waterbodies, and restoration of our degraded waterbodies and streams, is of great importance to fishermen and county residents in general. Learn more at <http://pfbc.maps.arcgis.com>



Photo by Rob Cronauer

*Westmoreland Conservation District Watershed Specialist Chelsea Walker collects data on fish populations in a stream in northwestern Westmoreland County.*

## INDUSTRY, RESOURCE EXTRACTION AND WATER USE

Industrial and resource extraction operations have a potential to use great amounts of water. For example, the recently-constructed 940 megawatt natural gas-fired power plant near Smithton in South Huntingdon Township purchases about 9 million gallons of water daily from the Municipal Authority of Westmoreland County (MAWC) for steam generation and cooling purposes. This water is being withdrawn from the Youghiogheny River at Connellsville, treated, and sent to the power plant via a new 13-mile pipeline. The plant's cooling tower system will evaporate most of this, about 7.5 million gallons per day classified as a consumptive use, and about 1.5 million gallons per day will be treated and returned to the Youghiogheny River near Smithton.

Non-conventional gas extraction (mostly from the Marcellus Shale) can require large amounts of water for hydraulic fracturing, called "Fracking". A non-conventional gas well may require five million gallons of

water to bring it to production of gas. The fracking water which returns to the surface contains metals, salts, and other chemicals and so it must be treated if it is to be released to waterways. Fracking water cannot be treated in a sewage treatment plant; it has too many salts and metals, and must be treated in a special system. Many gas drilling operations now reuse their fracking return water, saving the cost of disposing it. Conventional gas wells can impact water resources as well.

**Why is this important?** As industries grow and evolve, they must learn to use water sustainably so that it won't be harmed for future generations to use and enjoy. Industrial uses of water are generally subject to regulation and permitting by PA DEP; local sewer authorities have regulations about waste disposal as well. It is important for residents relying on well water to monitor their wells for quality and production if gas well drilling is nearby.

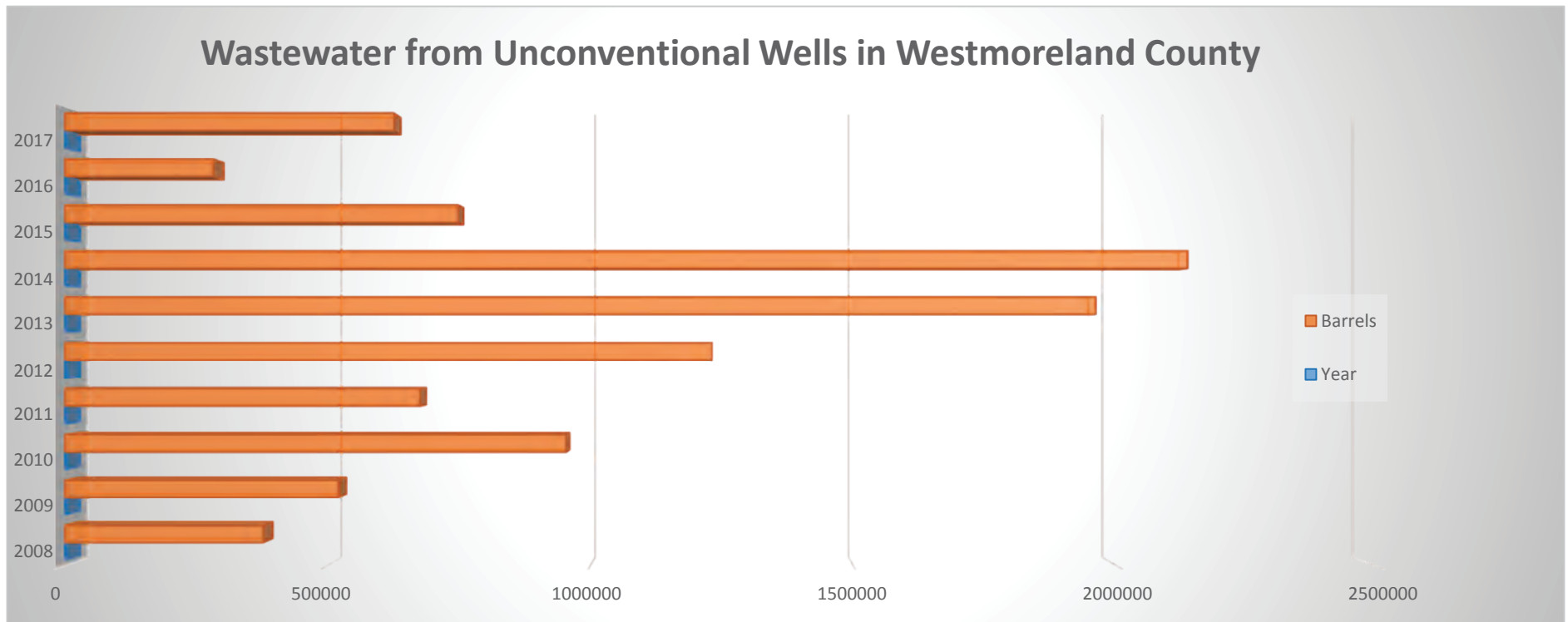



# Westmoreland County Conventional Oil & Gas Well Locations

## Legend

- Municipality Borders
- Conventional Well Location

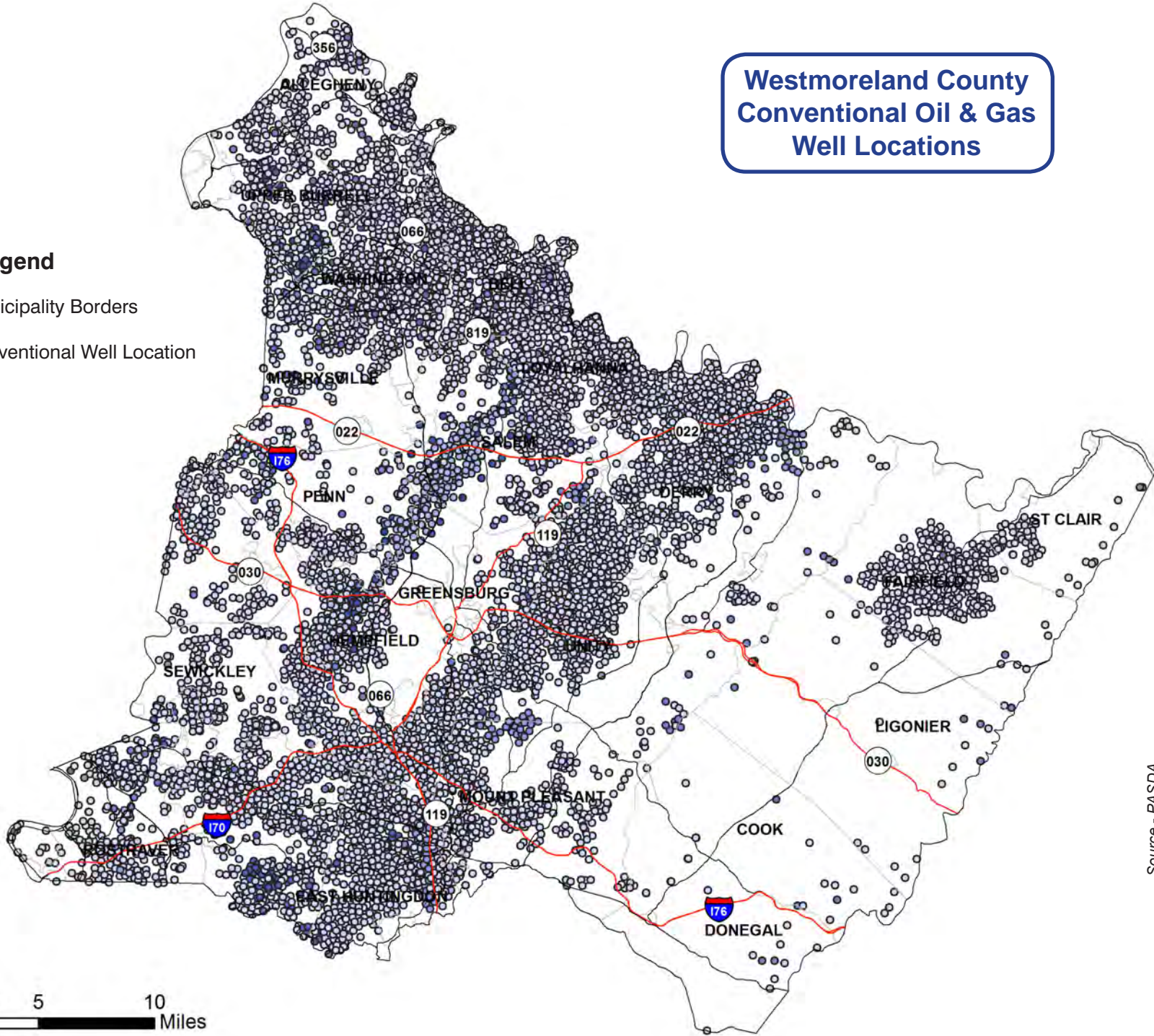

Source - PASDA



## DRINKING WATER AND WATER USE

Westmoreland County residents and visitors can get their drinking water from private wells or from one of the ten public and private authorities across the county. The map below indicates most public service is concentrated in the western communities of the county. A list of authorities that serve these areas can be found in the appendix. Drinking water is treated to remove suspended solids, minerals, and pathogens such as bacteria, viruses, and aquatic organisms. Mechanisms of treatment include filtering, addition of chlorine or other chemicals, and ultraviolet light. In much of the world millions of people are sickened

### Legend

- Westmoreland Municipalities
-  Public Sewer Service Area
-  Public Water Service Area

### Westmoreland County Public Water and Sewer Service Areas

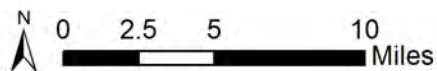
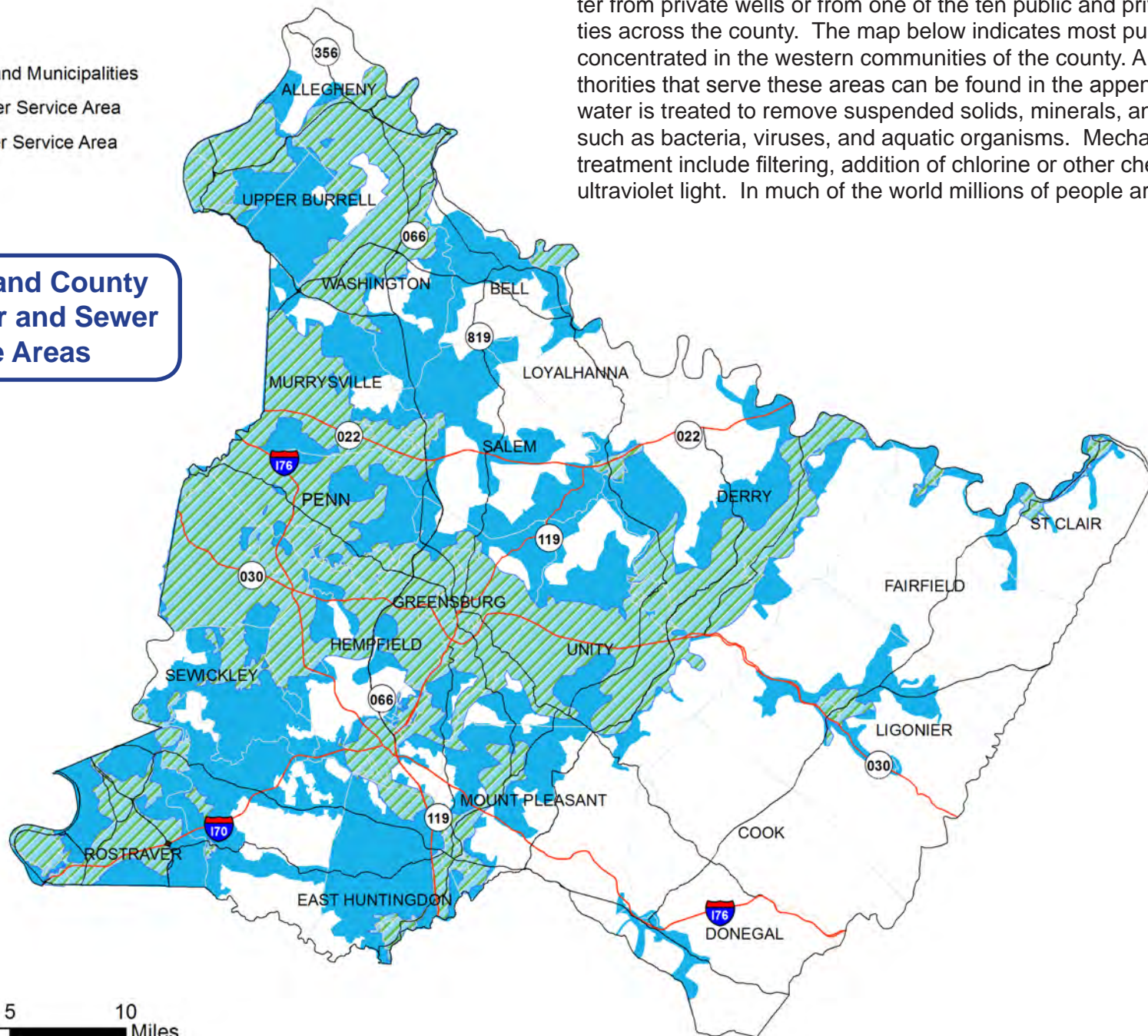



and die annually from water-borne diseases; our safe drinking water here in the US and especially in Westmoreland County is to be treasured.

The growth of population or the expansion of developed areas increases the demand for drinking water. Although Westmoreland County's population is not growing, our various water authorities continually expand their service areas as demand by housing or commercial use spreads. Growth in developed areas can have a negative effect on drinking water supplies by increasing the runoff of pollutants into source water reservoirs. In a reservoir's watershed area, it is important that land development follow best management practices to control erosion and sedimentation of streams feeding the reservoir. It's also important that reservoir watershed areas be protected from pollutants such as human waste and chemicals. Each water supply must have a source water protection plan identifying potential pollutants and how to address them.

**Why is this important?** Safe, plentiful, inexpensive, and good-tasting drinking water is the key not only to good health but to economic development as well. One factor which regularly hinders development in Westmoreland County is the lack of city water. Wells in our county are often tainted by iron and are usually very slow producers due to geologic conditions. A well with a flow of only two to three gallons per minute is not unusual in our county.



Photo by MAWC

'Morning Glory' spillway and intake tower at Beaver Run Reservoir

## WASTE WATER AND WATER USE

Westmoreland County residents and visitors may use private treatment facilities or the services of many of the 41 public and private authorities across the county for sewage treatment and disposal. Our public sewage treatment facilities treat an average of 65 million gallons each day. Most developed areas in the county are served by separate sanitary sewers and storm sewers. The sanitary sewers flow to a waste water treatment plant, where the sewage is treated to remove solid debris, fats and oils, and pathogens.

One problem faced in many of our county's older communities is that of combined sewers—a single pipe under the street which carries away wastewater from homes and businesses, and stormwater from hard

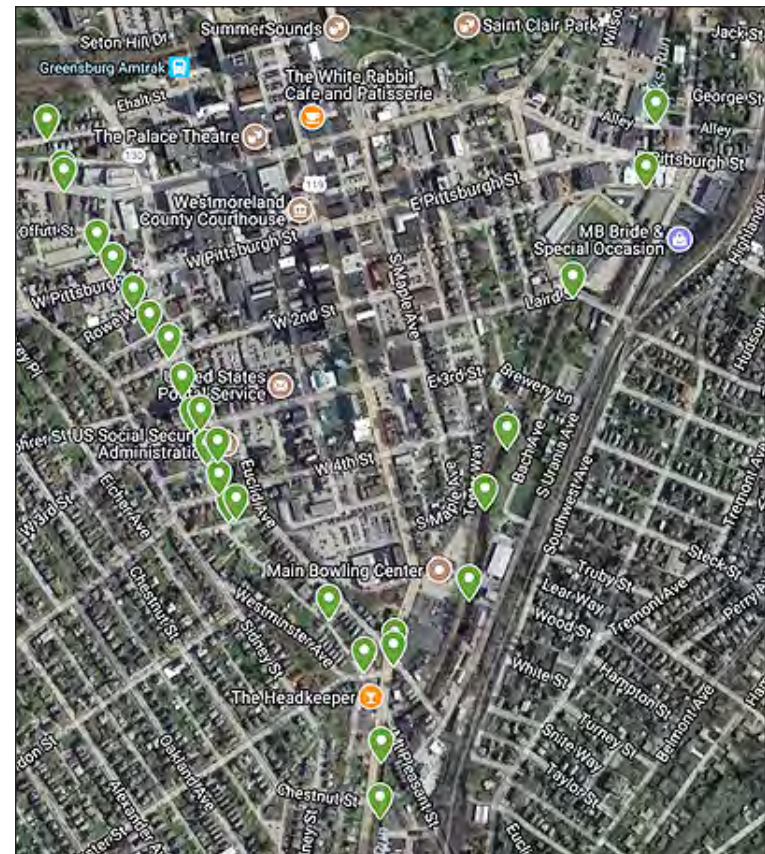

Image from Google, date from GGSA

Locations of CSOs in Greensburg along Jack's Run and Coal Tar Run



surfaces. These combined sewers can become overloaded during storms and overflow into our creeks and rivers, causing a pollution problem. In some areas, as little as ¼ inch of rain will cause an overload. Combined Sewer Overflows (CSO) can be handled by installing separate sewers in the community, storing excess flow in large tanks, and using green infrastructure practices to reduce stormwater runoff entering a combined system. Both Philadelphia and Pittsburgh are using green infrastructure to meet EPA-required CSO elimination goals.

**Why is this important?** Water-borne diseases kill 3.4 million people each year, according to the World Health Organization. Ninety percent of these deaths are children under the age of five. For the benefit of

our county's future, good sewage treatment is of inestimable value. Many of our rural county residents do not have an adequate sewage treatment system. Our soils are not conducive to standard septic systems because of our high groundwater, tight clay soils, and shallow depth to bedrock. New homes in rural areas need to have expensive alternative systems built to treat sewage, and many older homes may discharge their effluent to a stream, a roadside ditch, or even into a coal mine. Sewer authorities are steadily expanding their service areas to reach some of the unserved population. For a list of public sewage treatment authorities and information regarding private septic systems, see the appendix.



Image from Connect Explorer

Greater Greensburg Sewage Authority's treatment plant on Route 119 in Hempfield.



## STORMWATER MANAGEMENT

Stormwater management is the practice of reducing runoff and improving the water quality of rain water or melted snow that runs off undeveloped or developed land. When stormwater is absorbed into the soil, it is naturally filtered and will replenish the ground water or create base flow in streams. In developed areas, impervious surfaces, such as paving and roof tops, prevent this from happening. Stormwater runoff picks up pollutants, volume and velocity leading to flooding, erosion and other hazardous conditions.

Areas most susceptible to flooding are those located in floodplains. Floodplains are the areas where water is stored or moves outside the natural banks of a waterway or waterbody. The Federal Emergency Management Agency (FEMA) was established by executive order in 1979 to coordinate in the preparation, prevention, mitigation, emergency response and recovery for domestic disasters, natural or man-made, including floods. FEMA maintains Flood Insurance Rate Maps (FIRMs) for the National Flood Insurance Program (NFIP) which

identify the 100 year flood plain, the area where there is only a 1% chance of flooding from a severe storm in any particular year. Local governments utilize the 100 year floodplain to set regulations for new development, and to determine plans for hazard mitigation in areas developed without regard to the location of floodplains.

## FLOOD HAZARD AREAS

Westmoreland County contains 1,025 square miles or 656,000 acres of land with over 31,000 acres or 5% of the county in the 100-year floodplain. Of the 365,169 county residents, 9,188 or 2.5% live in the 100 year floodplain. This puts at risk both lives and property.

In 2014, the county updated its hazard mitigation plan and the risk assessment for flooding. Floods are one of the most common hazards in the US and are the most prevalent type of natural disaster occurring in Pennsylvania. According to the Pennsylvania Environmental Management Agency (PEMA) both seasonal and flash floods have been the cause of millions of dollars in annual property damages, loss of lives, and disruption of economic activities.

The main flood types of concern for Westmoreland County are riverine, flash, ice jam, and stormwater floods.

**Flash floods** are a rapid and extreme flow of high water into a normally dry area, or a rapid water level rise in a stream or creek above a predetermined flood level, often beginning only minutes after a storm event. Urban areas, where a high percentage of the land is impervious, are more susceptible to flash floods, where rapid rises in water level and devastating flow velocities can become deadly and damaging.

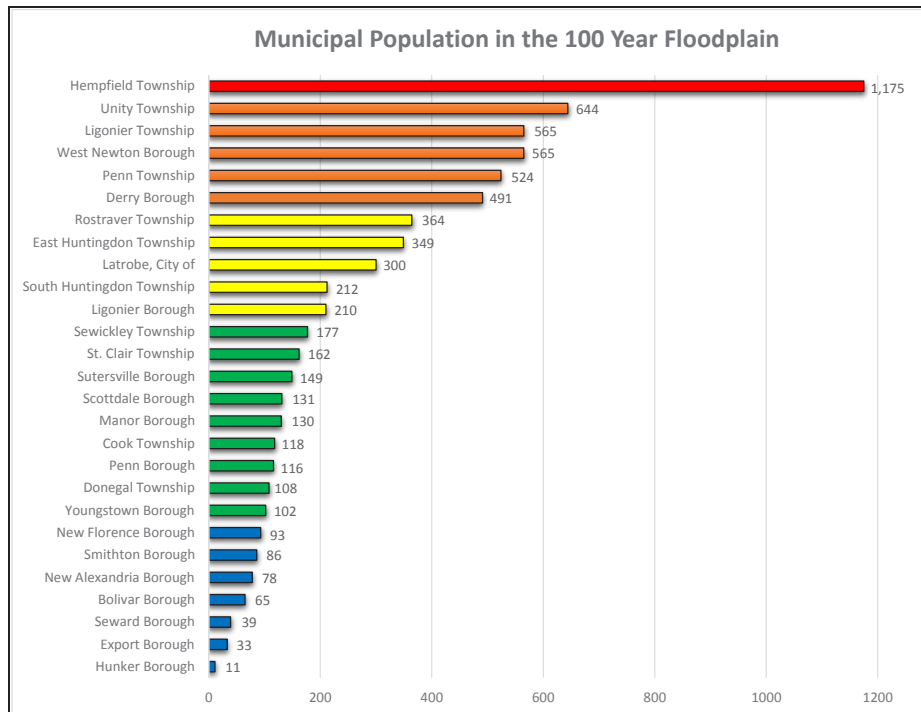

Data from Westmoreland County 911

This chart shows municipalities with significant population living in the 100 year floodplain.



Photo by WPXI TV

Stream, or riverine, flooding in Oakdale, PA, from Chartiers Creek.

**Ice jam floods** occur when an accumulation of ice acts as a natural dam restricting the flow of a body of water. Warm temperatures and heavy rains can cause snow to melt rapidly, rivers to swell and ice layers to break into large chunks. These chunks pile up near narrow passages and obstructions like dams and bridges, and can raise the water level enough to cause flooding. In Westmoreland County, both the Loyalhanna Creek and the Allegheny River experience ice jam flooding.

**Stormwater flooding**, or nuisance flooding, occurs in developed areas where inadequate infrastructure prevents rainwater from naturally reaching drainage channels. Instead, the water enters someone's basement, garage, or vegetable garden, causing localized but highly inconvenient and sometimes costly damage. Stormwater flooding is largely preventable by good design of land developments and good home construction practices.

**Riverine floods** are the most common and occur along a stream channel. These floods usually occur after prolonged heavy rains or snowmelt, are often slow rising, and generally develop over a period of hours or days. When a stream or river receives too much water, the excess water overflows its banks and inundates low lying areas.

## FLOOD CONTROL FACILITIES

The Army Corps of Engineers (ACOE) operates two flood control facilities in Westmoreland County; the Conemaugh Dam and the Loyalhanna Dam. The county owns the Natural Resources Conservation



Photo by Rob Cronauer

*The Westmoreland Conservation District helped build a debris basin in 2011 in New Kensington on Little Pucketa Creek to help control flooding of the Valley High School.*

Service (NRCS)-constructed Bridgeport Dam on the Jacobs Creek on the southern border of the county and the Acme Dam on Jacobs Creek between Donegal and Laurelville. The City of Jeannette owns the Bull Run Dam in Penn Township. Other flood control structures in the county include flood control channels, privately owned dams, and debris basins.

Flood control channels:

- Loyalhanna Creek in Latrobe
- McGee Run in Derry
- Turtle Creek in Export
- Jacks Run and tributaries in Greensburg area
- Jacobs Creek in Scottdale
- Little Pucketa Creek in New Kensington

Engineered flood control structures help prevent riverine floods that cause community-wide damage. However, they do not control the more frequent localized stormwater flooding that can cause expensive damage to homes and property. Low-impact development techniques and green infrastructure practices used in new and redevelopment can prevent stormwater flooding.

## OBSTRUCTIONS AND ENCROACHMENTS

Obstructions and encroachments are structures or activities that may change the course, current, or cross section of a body of water or waterway. Examples include bridges, culverts, utilities, walls, weirs, dams, and fills. Our county contains countless obstructions—natural and man-made. Every road culvert, bridge, and streamside retaining wall contribute to impacting stream flow. Historically, people have obstructed and encroached upon streams without much thought of adverse effects. A too-small culvert will back up water and flood homes, a squeezed stream channel will become clogged with debris, and an undersized bridge will fail in a flood. Inadequate, poorly planned, or unmaintained obstructions and encroachments can cause an economic loss and even loss of life. Sometimes a once acceptable obstruction becomes a large concern. In many places, suburban sprawl has rendered previously adequate culverts inadequate by the increase of runoff caused by residential construction.

To help prevent these personal and economic losses, and to protect



our water resources, PA DEP has established a program of permitting for water obstructions and encroachments (see Chapter 3). Some permits are issued by PA DEP's Regional Office, and some are issued by the local conservation district. Over the last four years the Westmoreland Conservation District has reviewed and issued nearly 400 stream encroachment permits, and the number is steadily increasing each year. The purpose of these permits is to protect the environment and property.

Large dams are another kind of obstruction. There are many large dams in Westmoreland County for water supply, flood control, recreation, and

for river navigation. Dams are permitted by PA DEP's Division of Dam Safety, and may meet the following criteria:

- Drainage area > 100 acres
- Embankment height above the original streambed of > 15 feet
- Storage capacity of > 50 acre-feet of water
- Construction of a dam which impacts wetlands

Each permitted dam must have an emergency action plan in case the dam starts to leak or overtop. Westmoreland County Emergency Management is the custodian of these plans.



Image from ACOE

*Loyalhanna Dam on the Loyalhanna Creek was completed in 1942 and is managed by the U.S. Army Corps of Engineers.*

## Westmoreland County Water Obstructions and Stream Encroachments

### Legend

-  Municipality Borders
- Encroachments including permits for work regarding bridges, culverts, utilities, streambank stabilization, wetland impacts and more

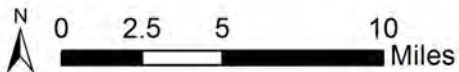
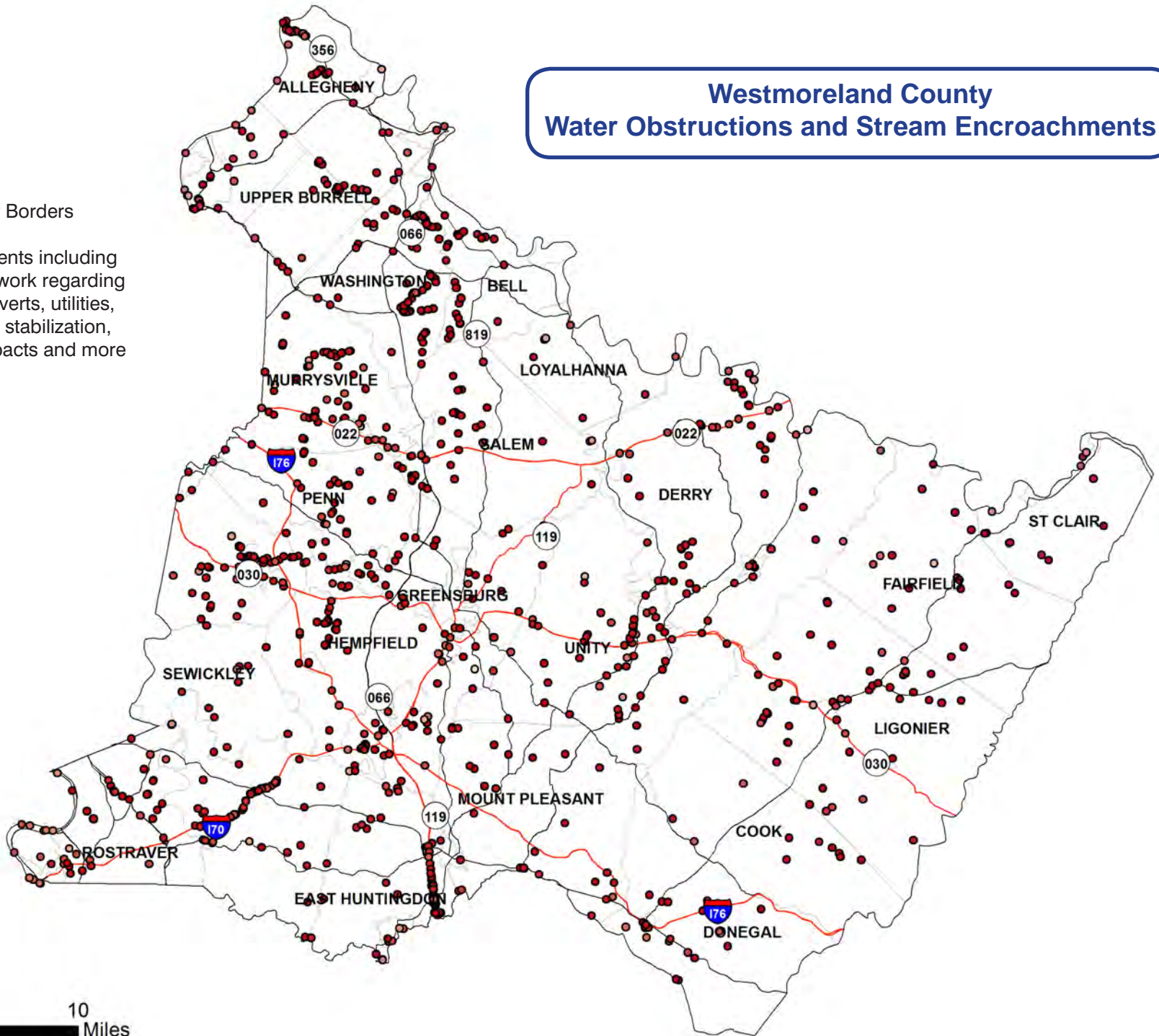

Source - WCD permits processed 2012 - 2016



## HYDROMODIFICATION

Hydromodification is the alteration of the natural flow of water through a landscape and often takes the form of channel modification or channelization. An example of this is a community's storm sewer system of inlets, pipes, culverts, and basic detention basins. Most of our county's communities have some kind of stormwater conveyance system similar to the example below of North Huntingdon Township's hydromodification mapping.

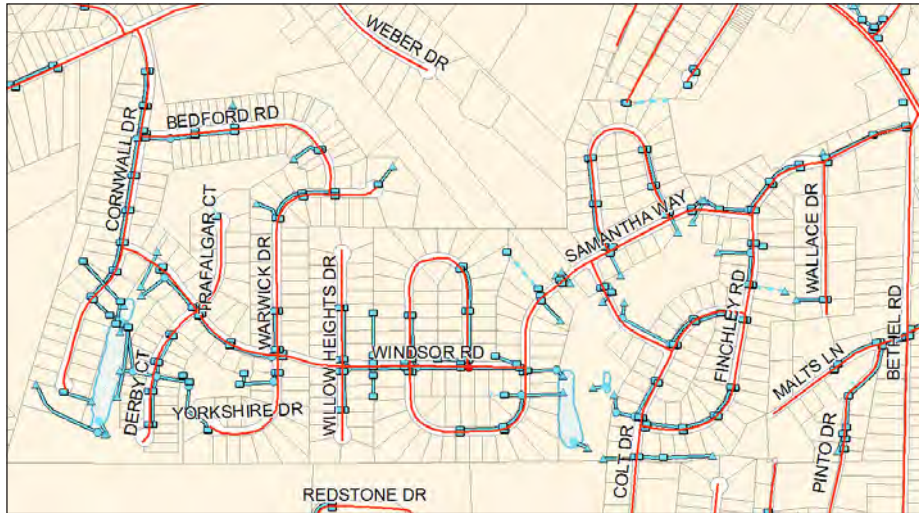

Source - North Huntingdon Township

North Huntingdon Township hydromodification map

In the natural condition, water flows across the land following the pattern of first, sheet flow; second, shallow flow; and last, channel flow. Sheet flow occurs high in a drainage area or a watershed, and is just a very thin layer of water feeling its way downslope through the roots of grasses and plants. Shallow flow may be an inch deep, slowly trickling downhill in rivulets. Channel flow forms where enough drainage area accumulates to the point where the flow has defined bed and bank. In a natural stream the water will move quickly in some places and slowly in others as it moves from pool to riffle to pool again, stepping its way down through the watershed.

Hydromodification changes the surface where water naturally sheets across. Grass or woodland soils are transferred to a hard paved surface into which nothing infiltrates and across which the water speeds towards a place of concentration like a street gutter. In a developed area, rainfall on the roof of a building rushes into the roof gutter and

down the downspout to the sidewalk or a driveway, with no opportunity to soak into the ground. Making its way to the street, the water picks up speed and again has no opportunity to infiltrate naturally into the ground as it races downhill to a storm sewer. Once in the sewer system, the rushing water has nothing to hold it back or slow it down as it roars to the bottom of the system, where the onrush erodes the stream channel into which it dumps. If the natural stream has been channelized with concrete bottom and sides, the water picks up even more speed with nothing to slow it down or hold it back to allow time for natural infiltration.

The end result of hydromodification is that more water gets to where it is not wanted faster than it should, and carrying with it sediment and pollutants. This fast moving volume of water overloads streams, erodes and undercuts streambanks, deposits sediment and debris, and devastates the stream's natural habitat.

For many years regulations have mandated the use of detention ponds to help control runoff from land development. A conventional detention pond will help offset the effects of hydromodification, but only to a



Photo by Alyssa Harden

Hydromodification: What's natural about this stream? Jack's Run in Southwest Greensburg



point. The detention pond will reduce the peak rate of flow, but in fact it doesn't reduce the volume of flow, and it may not improve the quality of runoff in an urbanized area. Streams feeding into detention ponds may fill the pond with sediment even if the runoff comes from a developed area. Streams receiving water from a detention pond may be eroded

and have habitat loss due to prolonged steady releases from the pond. New scientific research shows that instead of using one single detention pond to control runoff from a project, it's better to distribute the stormwater controls across the development site to try to replicate natural hydrological conditions by managing the water where it falls.



Photo by Chris Droste

*Stormwater detention ponds at the Tuscan Hills residential development.*



## STORMWATER MANAGEMENT ISSUES

Phase 1 of the Act 167 Plan identified the top three stormwater issues such as flooding, inadequate infrastructure, and water pollution from a total of seven categories of complaints which also included accelerated erosion, habitat loss or damage, sedimentation, or other issues. The

map below is a combination of issues identified in Phase 1 and those identified during the IWRP process and Phase 2 of the Act 167 Plan. The problems recorded are more than just a pin on a map—each one represents a place where stormwater is causing harm to people or the environment.

### Legend

Westmoreland Municipalities

### Stormwater Complaints

- Erosion
- Flooding
- Habitat loss
- Inadequate infrastructure
- Pollution
- Sedimentation

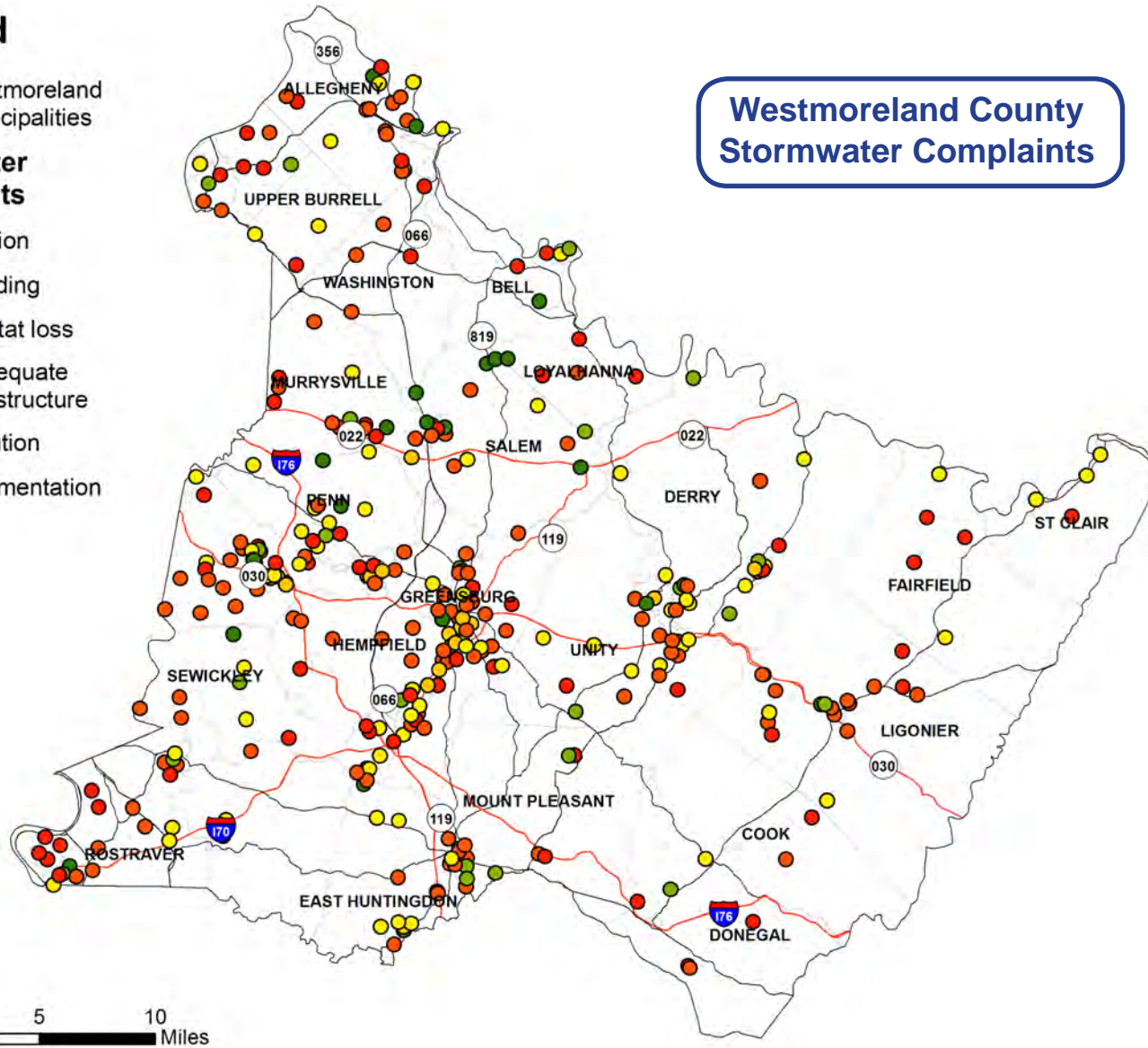

**Westmoreland County  
Stormwater Complaints**

Data from WCD logs 2014 - 2017 and Act 167 Phase I

Land development, while being one of the principal causes of stormwater problems, also can be designed and constructed to reduce or prevent problems. The best way to prevent land development activities from causing stormwater problems is for the developer to have a stormwater management plan, which shows how the proposed project will handle stormwater runoff.

PA Act 167 says that it is the “duty of persons engaged in the development of land...to assure that the maximum rate of stormwater runoff is no greater after development than prior to development activities... to manage the quantity, velocity, and direction of resulting stormwater runoff in a manner which otherwise adequately protects health and property from possible injury.”

Whether the stormwater plan is based on an Act 167 study or on standards outlined in a municipal ordinance, the goal is the same—to allow land development to take place without harming neighbors or the environment. For three decades the Westmoreland Conservation District has been reviewing stormwater management plans. As standards and approaches have changed, our reviews have changed, but our approach remains to treat stormwater as a valuable resource rather than as a waste material.

Recent individual site stormwater management plan reviews are enumerated by watershed in the following table:

<b>WCD stormwater management plan reviews by watershed for recent years.</b>					
<b>Watershed</b>	<b>2014</b>	<b>2015</b>	<b>2016</b>	<b>2017</b>	<b>TOTAL</b>
Conemaugh River	1	5	10	2	<b>18</b>
Indian Creek	2	3	3	1	<b>9</b>
Jacobs Creek	9	8	15	9	<b>41</b>
Kiskiminetas River	24	21	13	18	<b>76</b>
Loyalhanna Creek	34	55	59	42	<b>190</b>
Monongahela River	6	1	1	5	<b>13</b>
Pucketa Creek/Plum Creek					
Allegheny River	9	6	7	12	<b>34</b>
Sewickley Creek	46	50	58	51	<b>205</b>
Turtle Creek	48	33	51	64	<b>196</b>
Youghiogheny River	13	9	15	17	<b>54</b>
<b>TOTAL</b>	<b>192</b>	<b>191</b>	<b>232</b>	<b>221</b>	<b>836</b>



Photo by Rob Cronauer

*A heavy rain causes a large volume of stormwater runoff on Otterman Street in Greensburg, PA.*

## IMPAIRMENTS / POLLUTANTS

Water runoff from impervious areas can carry pollution from vehicles, yards, lawns, and farms to nearby waterways, which can potentially contaminate drinking water and harm aquatic wildlife. The Chesapeake Bay Foundation’s research shows that one inch of rain falling on one acre of paved surface equals 27,000 gallons of polluted runoff. Nationally, polluted runoff is responsible for more than 38,000 miles of impaired rivers and streams, 948,000 acres of impaired lakes, and nearly 80,000 acres of impaired wetlands.

The PA Water Plan 2009 defines impaired waters as those with “eroded or undercut banks, low water clarity, foul odors, large amounts of algae, or have deep deposition of sediments that cover larger rocks on the bottom of the stream.” The PA DEP under Section 303(d) of the Clean Water Act implemented a program that assesses the water quality of state waters and identifies waters that do not meet the standards for their designated uses. Designated uses such as aquatic life, recreation, and drinking water are characterized by the in-stream levels of parameters set by the state (dissolved oxygen, pH, metals, siltation, etc.).

If a water body or waterway does not meet the state standards for its designated use, it is considered ‘impaired’; the reasons for its impairment are determined and listed on the PA Integrated Water Quality Monitoring and Assessment Report.

[www.dep.pa.gov/business/water/cleanwater/waterquality/pages/default.aspx](http://www.dep.pa.gov/business/water/cleanwater/waterquality/pages/default.aspx)



**Legend**

Westmoreland Municipalities

**Chapter 93 Stream Classification**

- CWF(COLD WATER FISHES)
- EV(EXCEPTIONAL VALUE)
- HQ-CWF(HIGH QUALITY-COLD WATER FISHES)
- HQ-TSF(HIGH QUALITY-TROUT STOCKING)
- HQ-WWF(HIGH QUALITY-WARM WATER FISHES)
- TSF(TROUT STOCKING)
- WWF(WARM WATER FISHES)

**Westmoreland County Stream Classifications PA Title 25 Chapter 93**

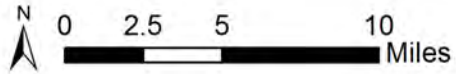
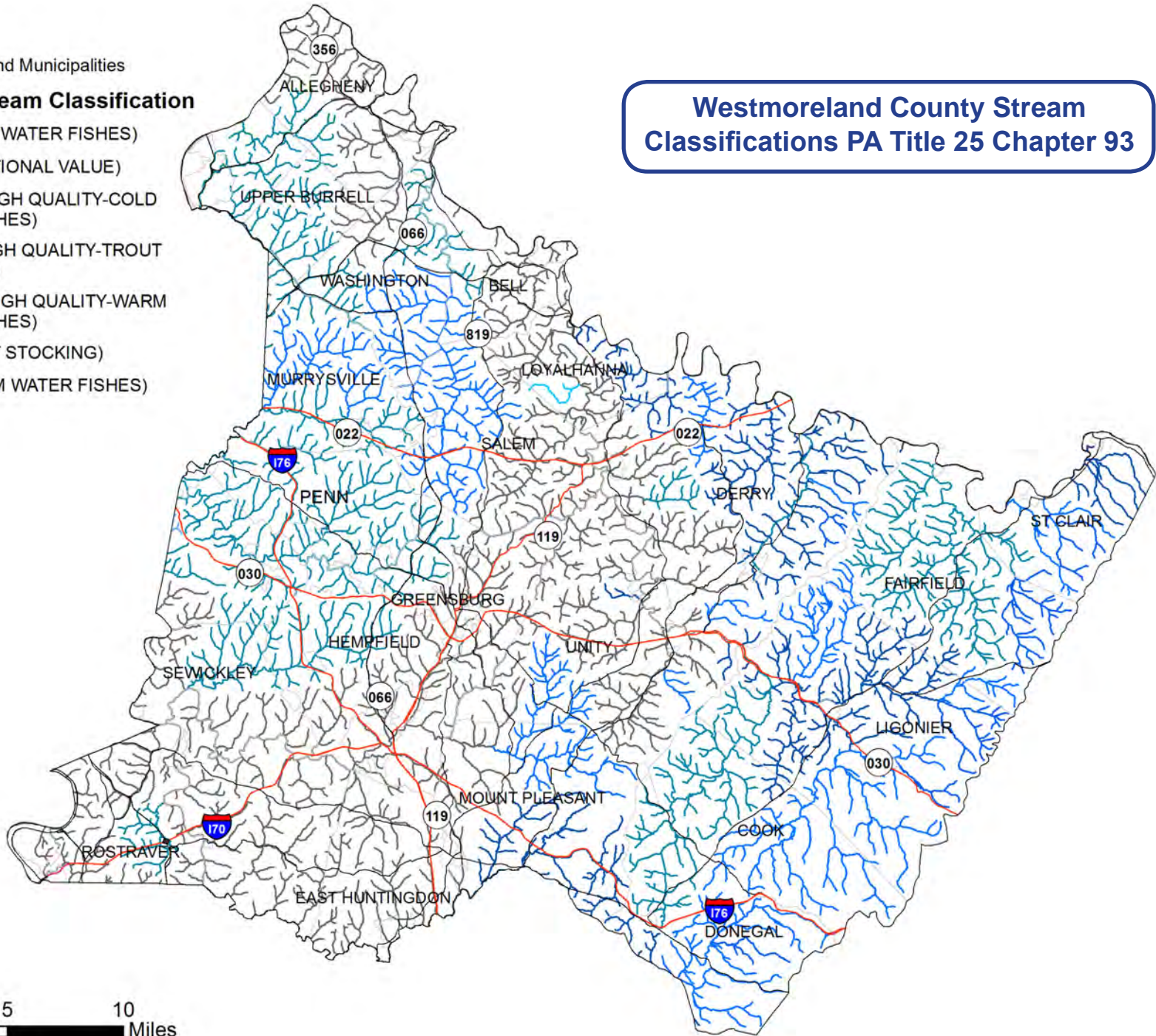



PA DEP, along with EPA and Penn State University, has determined what conditions are necessary to return the water to the quality that meets its designated use by developing a Total Maximum Daily Load (TMDL) for each impaired waterbody. A TMDL defines the allowable pollutant loads a waterbody can receive and still maintain its designated water quality standards.

On sites covered by an MS4 permit, pollutant control measures (best management practices) must be implemented to meet the following requirements dependent on stream classification:

- control metals and pH in stormwater discharges to impaired waters

- control pathogens (e.g. bacteria) in stormwater discharges to impaired waters
- control priority organic compounds (e.g., PCBs, Chlordane, etc.) in stormwater discharges to impaired waters
- control nutrients and/or sediment in stormwater discharges to impaired waters

Sediment in stormwater discharges harms aquatic life, clogs culverts and ditches, reduces the carrying capacity of a channel, and makes water difficult to treat for drinking.



Photo by Carnegie Mellon University

*Sediment, by volume is the number one pollutant of Pennsylvania's waters, causes impairment at the Point in Pittsburgh where the Monongahela joins the Allegheny.*



Causes of impairments to waters in Westmoreland County generally are abandoned mine discharge for metals and pH, malfunctioning septic systems and CSO's for pathogens, historical industrial activity for organic compounds, and agriculture and land development for nutrients and sediment. Stormwater carries with it other pollutants: according to the EPA and the Maryland Department of the Environment, the main pollutants sampled in Chesapeake Bay area runoff include: trash, soil, sediment, fecal bacteria, nutrients (nitrogen and phosphorus), oil and other petroleum products, pesticides and herbicides, road salt, and toxic metals including copper, lead and zinc.

Nature is able to address certain impairments, but as development increases, the natural ability of a watershed and its stream system to cleanse itself diminishes. Increased runoff prevents a natural area from absorbing nutrients like nitrogen and phosphorus, causing them to leave the landscape rather than be recycled back into the environment.

The Impervious Cover Model below, developed by the Center for Watershed Protection, shows a negative correlation between the amount of impervious surface and the level of stream quality. Watersheds having 10 percent or more of impervious surface begin to show stream degradation, illustrated by a decline in abundance and diversity of aquatic species. Watershed stressors such as untreated sewage and a lack of riparian buffers may increase degradation. When a

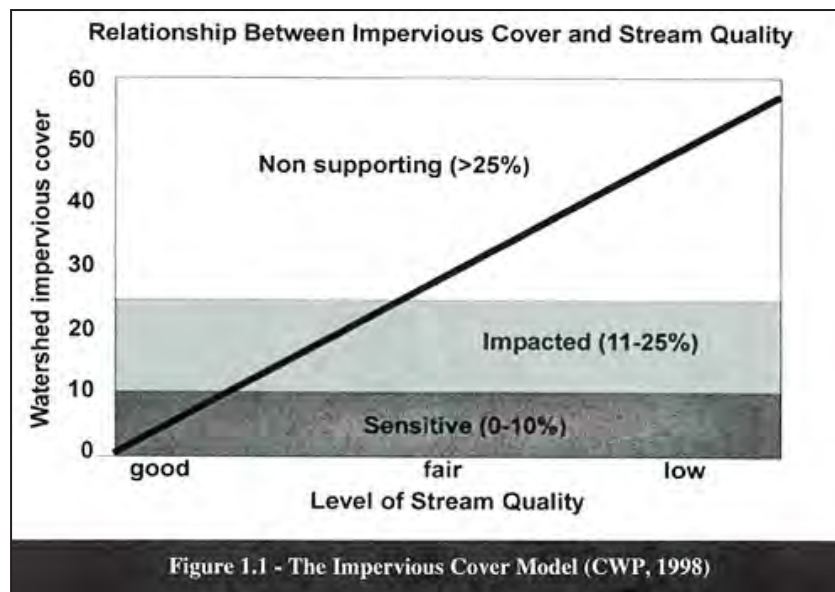

Figure 1.1 - The Impervious Cover Model (CWP, 1998)

Image from the Center for Watershed Protection

watershed reaches 25% impervious cover, it reaches the point where aquatic habitat is completely lost due to impairment and pollutants.

Because rainfall and snowmelt are not infiltrating into the groundwater system, normal stream baseflow is lower and aquifers may become depleted, leading to a dessicated streambed between rainstorms – one which cannot support aquatic life. Stormwater runoff from hard surfaces will contribute to thermal flashes, as the water coming from roofs and pavement is generally warmer than stormwater flowing over natural areas. Thermal pollution can negatively harm aquatic wildlife, which tend to tolerate very limited ranges of water temperature.

### Pre- and Post-Development Hydrographs

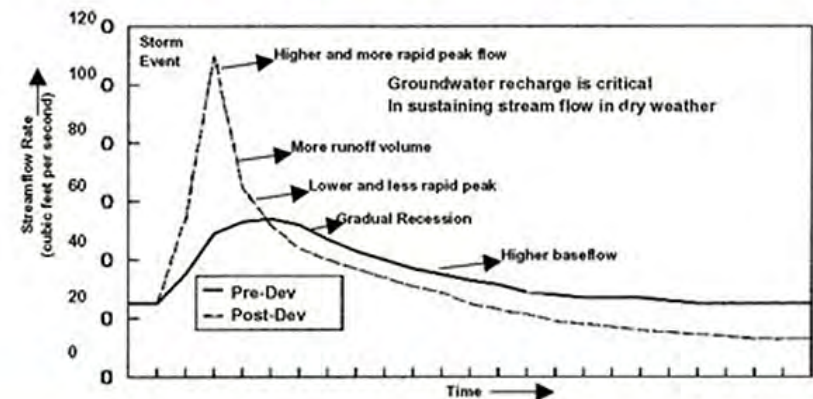

**Increases in impervious surface often decrease the amount of infiltration. Without infiltration, groundwater recharge rates will be reduced, and the stream base-flows will not be sustained at natural levels.**

The above engineering illustration shows the effect of land development on peak flow in a stream. Before development, the storm-flow peak is low, and the base flow is higher in relation to the peak. After development, the peak flow is very high, and the base flow is lower, due to loss of groundwater. Engineers calculate flow rates for land development projects and then apply 'best management practices' to the development, such as detention ponds, vegetated swales, permeable pavements, and rain gardens, to try to reduce the peak flow to pre-development levels. *Source: EPA*

Image from the Center for Watershed Protection

Designing site developments to handle changes in water quality will become more difficult in a changing climate. Climate change predictions for the northeastern United States indicate increases in precipitation as well as warmer winter months, which will feature more rain events than snow events. As a result, there will be more frequent, moderate runoff events. These runoff events will increase contaminant loads to waterways, particularly in the winter months when evapotranspiration and other biological processes are not as effective in managing stormwater runoff. *Source: USGS*

Uncontrolled runoff leads to flooding, erosion, and damaged roads and buildings. A quarter of flooding damage across the U.S. comes from uncontrolled suburban and urban stormwater runoff. Repeated flooding will cause property values to decline and diminish a community's tax base. *Source: Chesapeake Bay Foundation*

People may complain about the cost of stormwater management, but not having stormwater management costs money too, and harms property and the environment!

## ABANDONED MINE DRAINAGE / ABANDONED MINE LANDS

In 1968, after more than a century of unregulated coal mining, Pennsylvania passed the Land and Water Conservation and Reclamation Act, the first act in the nation to address abandoned mine reclamation. It included a bond issue for abandoned mine reclamation and mine drainage abatement within the Commonwealth.

The abandoned mine reclamation portion of the act, known as "Operation Scarlift," is still administered by DEP. A central component of Operation Scarlift was identification and monitoring of acid mine drainage (AMD) discharges from abandoned deep mines throughout Pennsylvania. Data on flow and chemical composition of mine discharges were compiled and used to assess the magnitude of the AMD problem, and to estimate the costs for collecting and treating AMD discharges.

Numerous mine drainage watershed studies were produced by both department staff and by consultants between 1968 and 1982, and many of these remain the best descriptions and outlines of the AMD problems in the watersheds.

Learn more about the Scarlift Watershed Reports at Western Coalition for Abandoned Mine Reclamation's Abandoned Mine Reclamation Clearinghouse website. <http://www.dep.pa.gov/business/landmining/abandoned->

[minereclamation/operationscarlift/Pages/default.aspx](http://minereclamation/operationscarlift/Pages/default.aspx)

**Why is this important?** AMD in our county impacts 280 miles of streams, suffocating aquatic life. Orange streams might seem normal to many, but they aren't supposed to be that color.



Photo by Brandon Battistella

*The abandoned mine drainage treatment site at Lowber, PA helps keep mine water pollutants such as iron oxide from entering the Sewickley Creek. The iron oxide settles out by passing from the old deep mine discharge through a series of settling ponds and a filtering wetland. The captured iron oxide is periodically harvested and sold for commercial uses such as stain pigment.*



# Legend

Westmoreland Municipalities

## AMD

- Extreme Health or Safety Impact
- Health or Safety Impact
- Environmental Impact
- Priority has not been determined
- No Priority assigned

# Westmoreland County Abandoned Mine Discharges

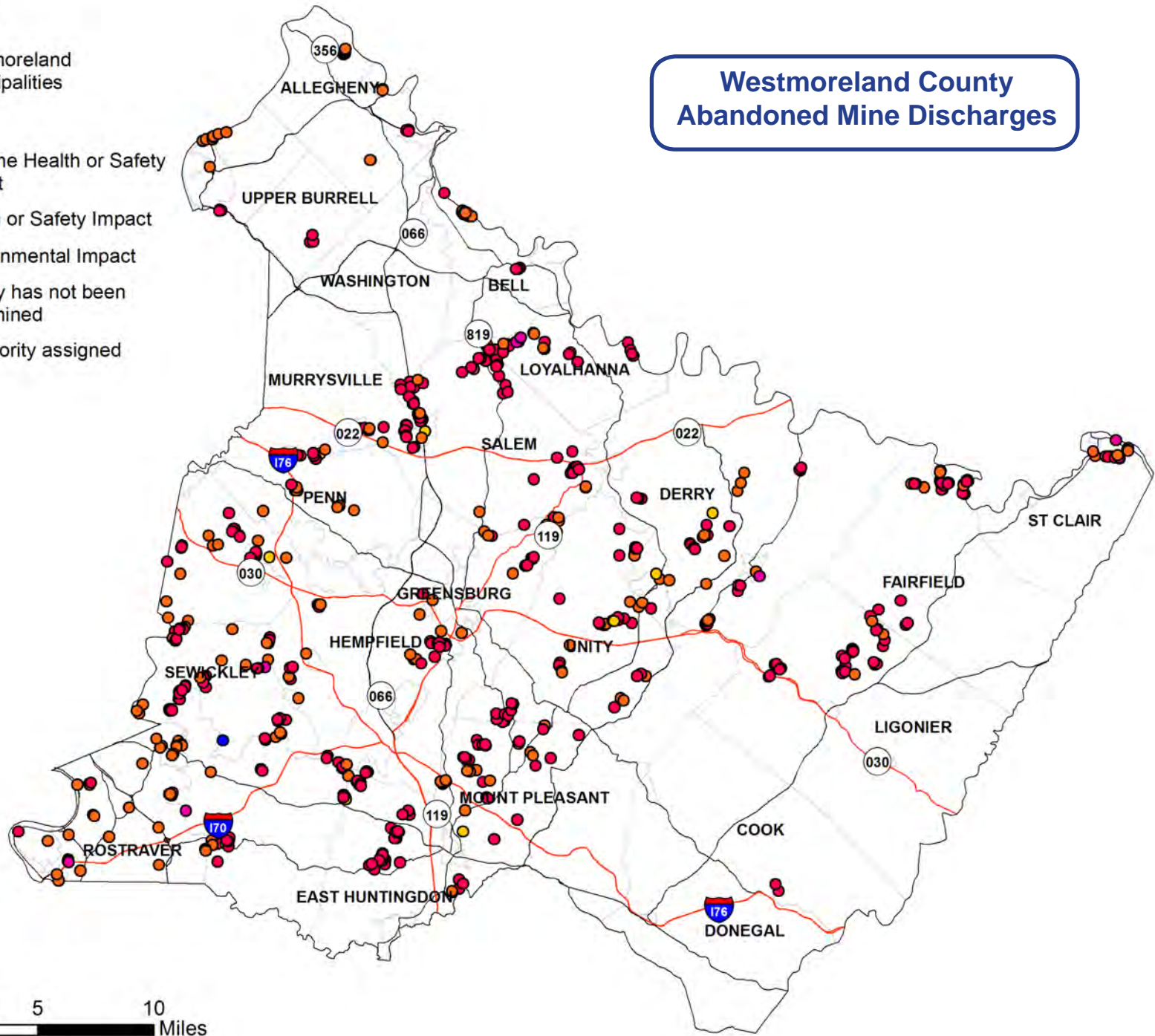

Source - PASDA



## FORESTRY AND TIMBER HARVESTING

*“Sustainably managed forests make a vital contribution to Westmoreland County by providing economic, environmental and social benefits indispensable to the quality of life. A commitment to sustainable forest management means protecting water quality, soil, wildlife and unique resources; promoting human health and safety; and communicating the benefits of the practice of sustainable forestry.” - from Sustainable Forestry Initiative*

Westmoreland County’s hardwoods are used both locally and domestically, and are exported overseas to make furniture. Timber harvesting may include ‘clear-cutting’ of an entire stand of trees, or some form of selective cutting where particular trees are harvested according to certain criteria such as diameter, age, type, quality, etc. Properly done, when managed by a professional forester, timber harvesting will allow the forest to regenerate itself, and can be done sustainably over the years. Timber harvesting does not harm water resources, especially if the workers follow appropriate standards and protect streams and wetlands they encounter. PA DCNR Bureau of Forestry has developed timber harvesting standards to protect water resources—this is especially important in stream headwaters areas on the timber-rich ridges in the eastern part of our county.

Timber harvesting operations conducted within Pennsylvania are regulated to minimize their impacts on soil and water resources and must be undertaken in accordance with Chapters 93, 102 and 105 of Pennsylvania's Title 25 Environmental Protection code (under the authority of the Clean Streams Law and enforced by the PA DEP) and the Federal Clean Water Act (enforced under the joint authority of the U.S. EPA, and the U.S. Army Corps of Engineers).

All timber harvesting operations in Pennsylvania must have an ‘Erosion Control Plan for Timber Harvesting Operation’ that has been approved by the Conservation District to minimize erosion and sediment pollution, considering such factors as topographic features, soils, and quantity of runoff, and is available onsite at the timber harvest site. PA DEP regional offices are responsible for enforcing the regulation and the program is delegated to the county conservation districts to administer.



*Westmoreland Conservation District Forester Tony Quadro measures the diameter of a tree in a forest in Westmoreland County.*

Photo by Mark Jackson



## WESTMORELAND COUNTY STREAM CLASSIFICATIONS

PA DEP protects four stream uses: aquatic life, fish consumption, potable water supply, and recreation. The Aquatic Life use attainment is the integrity reflected in any component of the biological community

(i.e. fish or fish food organisms). Fish Consumption use attainment is the risk posed to people by the consumption of aquatic organisms (ex. fish, shellfish, frogs, turtles, crayfish, etc.). Recreational use attainment is the risk associated with human recreation activities in or on a water body (i.e. exposure to bacteria and other disease causing organisms through water contact recreation like swimming or water skiing). Potable Water Supply use attainment is the risk posed to people by the

### Legend

Westmoreland Municipalities

### DEP Stream Classification

Not Attaining  
Attaining

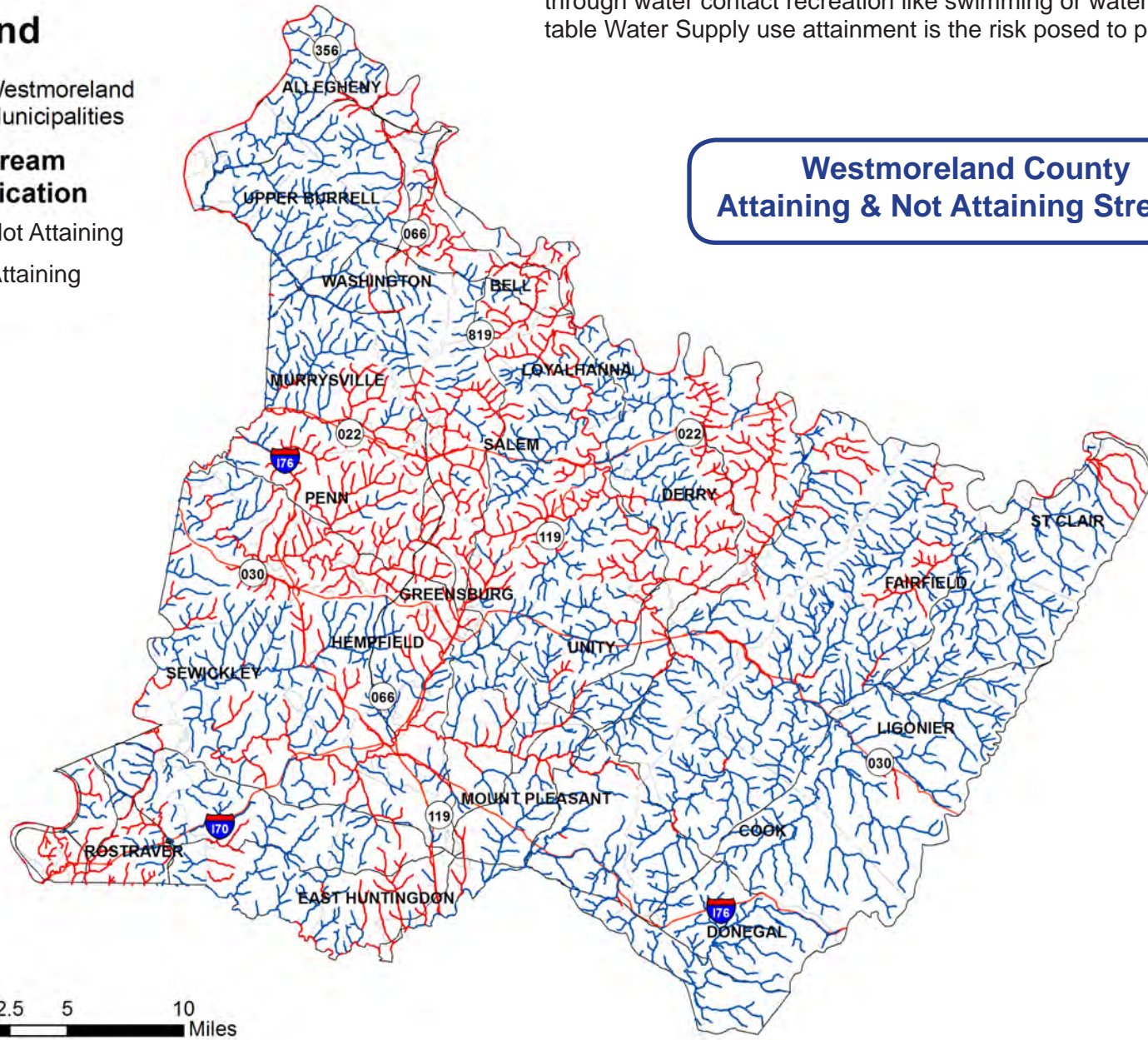

**Westmoreland County  
Attaining & Not Attaining Streams**

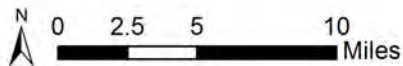

Source - PA DEP



ingestion of drinking water. The Chapter 93 stream classification list indicates segments that have been evaluated for attainment of those uses, and if a stream segment is not attaining any one of its four uses, it is considered impaired.

For more information, follow this link below:

<https://www.pacode.com/secure/data/025/chapter93/chap93toc.html>

Some streams in Westmoreland County are classified as Exceptional Value—or, in layman's terms, the water is so good you could almost drink it! (but you should not). High Quality streams have a water chemistry that is great for supporting aquatic life: high level of

dissolved oxygen, close to neutral pH, and low levels of nutrients, metals, pathogens, and other pollutants. A stream that classifies as Trout Stocking (TSF) means that if someone puts trout there, they will survive for a time, long enough for someone to catch them! Cold Water Fishes (CWF) indicates that the stream's temperature does not rise high in the summer, due to cool groundwater input into the stream and due to extensive shading of the stream by trees and shrubs. Fish prefer cold water because it holds more dissolved oxygen than warm water. In developed areas, most streams are classified as Warm Water Fishes (WWF). Such a stream might support 'low-quality' fish like carp, but it does not have the biological diversity or chemical purity of a higher-quality stream.



Loyalhanna Creek

Photo by Stephen Simpson



## CLIMATE CHANGE

Changing climate patterns can impact how we manage stormwater and sustain our other water resources. Climate change has become a political issue, but in reality, the data should be approached scientifically and with engineering to effectively address the issue for the benefit of all.

In May 2017, the US Army Corps of Engineers (ACOE) partnered with NOAA to create a study titled 'Ohio River Basin – Formulating Climate Change Mitigation / Adaptation Strategies through Regional Collaboration with the Ohio River Basin Alliance'. The complete study can be found at [http://www.corpsclimate.us/docs/USACE%20Ohio%20River%20Basin%20CC%20Report\\_MAY%202017.pdf](http://www.corpsclimate.us/docs/USACE%20Ohio%20River%20Basin%20CC%20Report_MAY%202017.pdf)

The report investigated potential climate change impacts to:

1. Ohio River Basin (ORB) infrastructure, including flood control, water supply, hydro-electric power production, and navigation; and
2. Terrestrial and aquatic ecosystems that are influenced by infrastructure components.

The climate change project modeled past conditions from 1951 to 2001 to calibrate the model for future periods. The project then modeled proposed future conditions. The predicted overall trend for the northeastern portion of the ORB (where Westmoreland County lies) over the next 30 to 80 years is warmer, wetter weather with a greater variability in weather systems as shown in the figures below. The mean, minimum, and maximum flows will still fall within historical ranges through the year 2040, after which flows will tend to increase. In certain locations in the ORB, autumn precipitation may decline and river flows may drop.

The ACOE study suggests that we will be getting wetter weather, warmer weather and less snow, but more individual and random intense storms. The study encourages climate preparedness and resilience especially regarding hydrologic analysis, because the various uses of water will be affected:

- Drinking water: plenty of water will still be available but it may be more muddy and require a higher level of treatment
- Sewage: flooding may impact treatment plants and higher precipitation will mean more incidences of Combined Sewer Overflow (CSO) and

- River transportation: higher flows may damage aging locks and dams and at certain times require river traffic to be shut down for fear of barges breaking away
- Agriculture: more rain and warmer temperatures can make plants grow better, but muddy fields make it difficult to plant and harvest crops, and erosion of farmland may increase
- Recreation: more water pollution and higher flows may make boating and swimming difficult
- Ecosystem: higher flows and warmer water temperatures in small streams will change the habitat for various species including the sensitive macroinvertebrates at the bottom of the aquatic food chain



*Heavy rain covers an intersection.*

Photo by Mark Jackson

- Stormwater management: older storm drain systems will become inadequate, detention ponds will fill more frequently, and the use of alternative and green infrastructure practices like rain gardens, permeable pavement, and green roofs will become more important as we try to protect our small streams from flash flooding
- Flood control: the importance of regional flood control dams and channels will grow

The ACOE climate change study shows that water managers and especially stormwater management professionals have much work to do to protect the environment, life, and property in the next several decades.

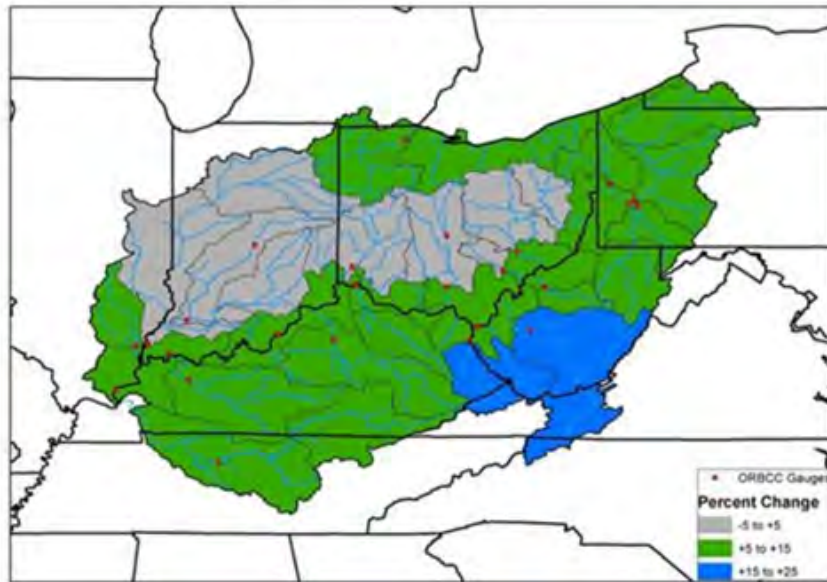

Source - ACOE Study

Forecasted Percent Change in Annual Mean Streamflow (2011-2040)

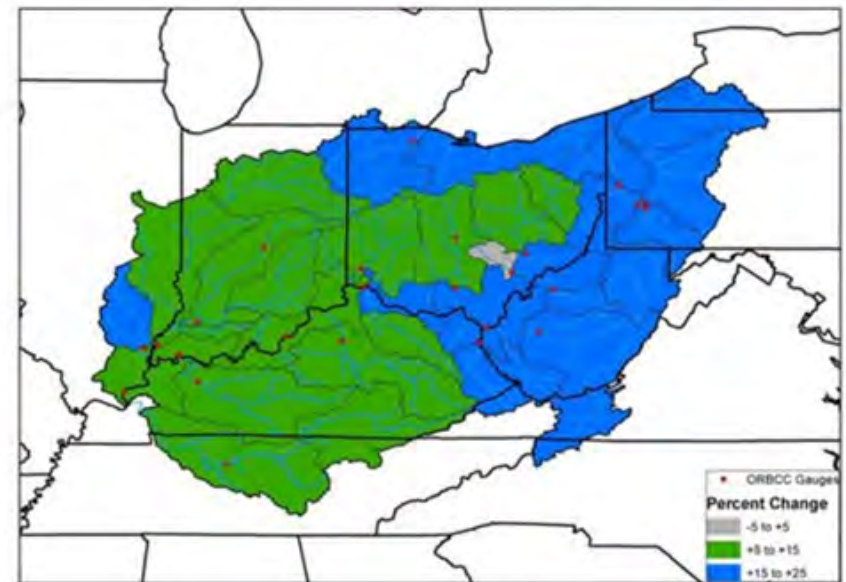

Source - ACOE Study

Forecasted Percent Change in Annual Mean Streamflow (2041-2070)



## Chapter 5. ISSUES AND CHALLENGES

Westmoreland County has an abundant supply of surface and ground-water resources as illustrated in Chapter 3, but there are significant impacts on those resources as covered in Chapter 4. These impacts have resulted in numerous issues and challenges which are covered more thoroughly through watershed modeling and pollution accumulation modeling in this chapter.

### WATERSHED MODELING

Watershed modeling is a tool that engineers and scientists use to study stormwater infrastructure and how it relates to land development and other activities. Westmoreland County has ten distinct major watersheds shown on the map below, some shared with adjacent counties. Each watershed has a unique set of problems and issues. US EPA and PA DEP have established the foundational rules and regulations for new development, redevelopment, and the management of stormwater resources. These rules, found in PA DEP's Chapter 102 NPDES regulations, require the control of increased rate of runoff (cubic feet per second) for the range of expected storms. They also require the control of increased volume of runoff (expressed usually in cubic feet) of the small, frequent two-year storm. Controlling the rate and volume of runoff from the small, frequent storm also results in control of pollution of stormwater, for many studies have shown that the small, frequent storms are the most polluted by runoff from developed surfaces.

The Westmoreland County IWRP offers tools and resources to satisfy those regulations at the watershed level. Furthermore, the IWRP addresses those areas of the county where stormwater has previously been unmanaged and uncontrolled through the model stormwater management ordinance and the watershed performance districts determined by this plan.

Although the IWRP considered the entire county, it includes a more in-depth look at the 10 priority watersheds/areas of interest (AOI) identified in the Act 167 Phase 1 report, especially those within the highly developed growth triangle in the western part of the county, and those within established, built-out older communities affected by water issues.

AOI's include:

1. Turtle Creek
2. Sewickley Creek
3. Kiskiminetas River AOI (Delmont/Beaver Run)
4. Conemaugh River AOI (Derry/McGee Run)
5. Loyalhanna Creek AOI (Latrobe, Ligonier)
6. Monongahela River
7. Pucketa Creek, Plum Creek, Allegheny River
8. Jacobs Creek
9. Youghioghny River
10. Indian Creek

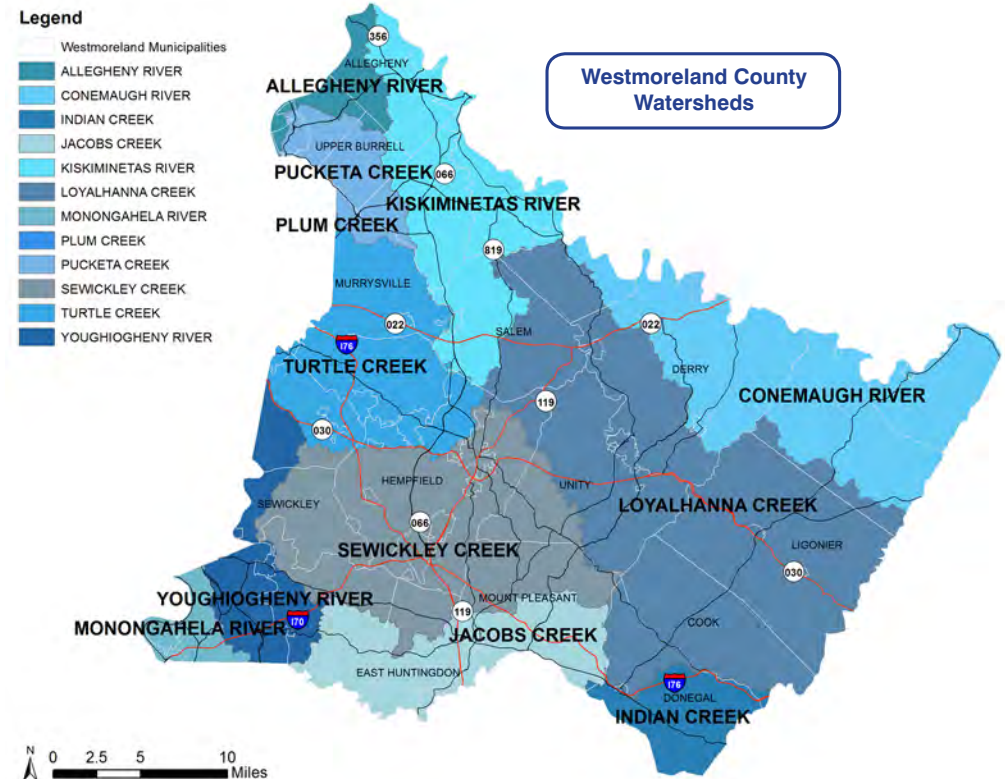



*Paddle-boat rentals are popular at the Twin Lakes County Park Boathouse.*

## WHY WE STUDIED THE TEN WATERSHED AREAS OF INTEREST

Westmoreland County is naturally divided into watersheds – areas defined by landform which gather runoff from storms into a stream or other body of water. Ten major watersheds receive runoff from land in our county. Our river watersheds are the Allegheny, Kiskiminetas, Conemaugh, Monongahela, and Youghiogheny. Our creek watersheds are Indian, Jacobs, Loyalhanna, Pucketa, Plum, Turtle/Brush, and Sewickley. The Loyalhanna Creek watershed has the largest drainage area in the county of 298 square miles which includes all or part of 15 different municipalities from the southeastern part of the county to the north central. In contrast, the Plum Creek watershed drains only a few dozen acres of far northwestern Murrysville. Ultimately all the runoff in the county reaches either the Monongahela River via Indian, Jacobs, Sewickley, and Turtle/Brush creeks and the Youghiogheny River, or the Allegheny River via Plum, Pucketa, Kiskiminetas, and Loyalhanna creeks and the Conemaugh River. So our county, which lies upstream of the famous Golden Triangle at Pittsburgh, contributes directly to the Three Rivers.

Westmoreland's streams and waterbodies also help to form some of our political boundaries – the Conemaugh, the Kiskiminetas, and

the Allegheny rivers form the northern boundary of the county while Jacobs Creek helps bound the southern edge of our county. However, many of our political boundaries have no relation to the physical boundaries of watersheds, and so many of our streams drain several municipalities, and many of our municipalities lie within several different watersheds. The natural flow of water does not heed man-made boundaries; for this reason, we conducted our stormwater study by watershed, and not by municipality.

The IWRP focuses on ten areas of interest (AOI) in Westmoreland County identified in Phase 1 of the Act 167 Plan and which were studied in detail for the IWRP and Phase 2. These ten AOIs, watersheds and sub-watersheds represent a cross-section of developing areas across the county, and were chosen based on various factors including a history of flooding and stormwater problems, land development activities, and environmental concerns. The need for study, while required by Act 167, is also necessitated by a historical lack of controls on land development across the county, resulting in encroachment on and degradation of our streams. The intent of the IWRP—to manage our county's water resources wisely—means these streams, their ecological environs, and the neighborhoods they flow through, need to be studied in more detail. The ten AOIs and the reasons they were chosen for further study are outlined here.

### Countywide:

It is important to note that areas of Westmoreland County which were not studied in detail are still in need of stormwater management, not only for peak rate control but for runoff volume and water quality. Nearly every stream in our county, even those in rural areas, has reaches where it has been impacted by human activities. While rural residents may enjoy the unspoiled beauty of our countryside, they also may suffer from flooding or erosion damage. Furthermore, as the urban sprawl type of growth continues to spread along our major transportation corridors, these rural areas will find themselves targeted for large residential, commercial, and industrial projects. Conservation, and the wise use of natural resources, requires us to plan and study how the inevitable spread of development may be best managed. For these and many other reasons, our IWRP provides standards and sets requirements for all of the county, urban, suburban and rural areas, based on the ten priority watershed AOI findings.



### **Turtle Creek/Brush Creek AOI:**

Turtle Creek is a 147 square mile watershed that spans the border between eastern Allegheny and western Westmoreland counties. The entire two-county Turtle Creek watershed was studied in 1990 as Westmoreland's very first Act 167 study, done in cooperation with Allegheny County. The 98 square miles of the watershed which lies in Westmoreland County makes up the AOI. Commonly called the Turtle Creek watershed, more of the Westmoreland County portion drains to Turtle Creek's main tributary Brush Creek than to Turtle Creek itself, but the watersheds were considered jointly. The AOI features much dense residential development, old and new industrial areas, major transportation routes including the main line of the Norfolk Southern railroad, the Pennsylvania Turnpike, and State Routes 22 and 30, and many commercial properties. The watershed is home to thousands of county residents and host to many flooding and water quality problems. Abandoned mine drainage (AMD), stream habitat loss due to human encroachment, severe historical capacity-limiting obstructions, and pollution from the built environment are important factors in this watershed.



Photo by Pictometry

*The heavily-developed and industrialized Brush Creek valley in North Huntingdon Township.*

### **Sewickley Creek AOI:**

Sewickley Creek AOI is the entire 168 square mile watershed that drains the center-south portion of the county. While it is home to a concentration of many of our county residents, this area also is host to many farms and rural properties. Our county's commercial heart, the Route 30 corridor around Greensburg, lies in this watershed, as do the County Seat, Greensburg, the area's largest township by population, (Hempfield), and innumerable suburban residential subdivisions. The automobile and its impacts dominate this watershed, which features Interstate 70, the Pennsylvania Turnpike, (and their major interchange in New Stanton), US Route 119, and US 30. Industry and former coal mining sites are also common in this area. Major flooding events over the years have caused economic hardship and property damage, and the presence of AMD hinders aquatic life in many of the tributaries and main stem.



Photo - New Stanton Borough

*New Stanton, PA and Interstate 70, circa 1960*

### Kiskiminetas River AOI:

The Kiskiminetas, or Kiski, River is formed by the confluence of the Loyalhanna Creek and the Conemaugh River and flows northwest to the Allegheny River. This watershed is not densely populated, and the study area is a small portion of it – a 15 square mile AOI draining into the Beaver Run Reservoir, a source of drinking water for much of the northern portion of the county. The study area encompasses the very busy intersection of PA 66 and US 22, the commercial area adjoining it, and the historic old town of Delmont, first settled about two hundred years ago. Development and redevelopment pressure in this area points to a need to address stormwater and other water issues.



Photo by Mark Jackson

Historic Delmont, PA – Pittsburgh Street looking east.

### Conemaugh River AOI:

The Conemaugh River begins in Johnstown, and drains portions of four counties – Somerset, Cambria, Indiana and Westmoreland. Combined with the Loyalhanna Creek to form the Kiskiminetas River and draining a portion of Armstrong County as well, the entire Kiski-Conemaugh River Basin is 1,887 square miles. The Conemaugh Dam, a massive ACOE flood control project built upstream of the confluence with the Loyalhanna Creek after World War II, provides flood control for this river and for the Pittsburgh region downstream and is not part of the study area. The 14 square mile AOI for the Conemaugh watershed centers on Derry Township and historic Derry Borough, a town created by the Pennsylvania Railroad as the western terminus of its mountain division. The Derry area has numerous stream impacts due to industrialization, which need to be addressed as the area is gradually being redeveloped with more ‘green’ industry, homes, schools, and shopping districts.



Image - Wikipedia/public domain

Derry Borough from the west.



### Loyalhanna Creek AOIs:

The Loyalhanna Creek is our county's largest watershed at 298 square miles and drains nearly one-third of the county from the southeast to the north central part of the county. The Loyalhanna watershed contains woods, farms and urban/suburban areas that are not evenly distributed across the watershed. The IWRP included 2 separate AOIs in this watershed to focus on the existing urbanized areas. The northern, or downstream area in the watershed is rural in nature, is dominated by a US ACOE flood control channel and the Loyalhanna Dam built before World War II, and was not studied. The first AOI is located in the central portion of the watershed and features the urban area of Latrobe and portions of Unity and Derry Townships, a developed, industrial, and growing region. This area has various historical flooding and water quality problems affecting homes and businesses. The southeastern portion of the watershed is largely wooded, with the exception of the Ligonier area, and contains the second AOI, which covers the Mill Creek watershed and a portion of the Loyalhanna's upper corridor that contributes to flooding issues in the urban area of Ligonier.



Photo by Mark Jackson

*Saint Vincent College near Latrobe, in the Loyalhanna Creek Watershed.*

### Monongahela River AOI:

The Monongahela River, known locally as the Mon, has long been the Pittsburgh region's industrial workhorse, carrying coal and raw materials to support the important steel industry. This north-flowing river drains land from West Virginia and Maryland as well as several counties in Pennsylvania. The 14 square mile AOI includes a portion of developing Rostraver Township that is tributary to the section of the Mon in Westmoreland County. Some of the tributaries included in the AOI have been impacted by coal mining, transportation infrastructure, and land development.



Photo by Mark Jackson

*Boat launch on the Monongahela River at Monessen*

### **Pucketa Creek, Plum Creek, Allegheny River AOI:**

Pucketa Creek, Plum Creek, and the Allegheny River lie in the northwestern part of our county and the AOI covers a 46 square mile portion of these watersheds. This study area has had some historical flooding problems and is under continued pressure from land development and urban sprawl. This northwest area of the county, historic home to America's aluminum industry, has steeper slopes than other areas, with the associated rapid runoff and erosion that occurs from those sloping, clayey soils. A lack of historical stormwater management practices, combined with excessive floodplain encroachment, leads to a need for attention to stormwater management.



Photo by WCIDC

*The new face of industry in the Pucketa Creek Watershed: Westmoreland County's Business and Research Park—no soot, no smoke, and hundreds of 'clean' jobs. WCIDC*

### **Jacobs Creek AOI:**

Jacobs Creek covers 98 square miles in Fayette and Westmoreland Counties with 75% of the watershed lying in Westmoreland. It originates in the forestland of the Laurel Mountains and forms a portion of Westmoreland County's southern boundary. The AOI lies in the mid-section of the watershed, and encompasses a 30 square mile area. The AOI features an area known for coal mining, industry, and bustling small towns; one hundred years ago Henry Clay Frick had 999 beehive coke ovens in Standard Shaft, just north of the farming and business center of Mount Pleasant Borough. Leaving the Mount Pleasant and Scottdale areas, Jacobs Creek flows through the very scenic and very rural Creek Hills area before emptying into the Youghiogheny River. The main channel of Jacobs Creek is well-protected from flooding by a project completed by USDA-Soil Conservation Service which included construction of three flood control dams and a flood channel. However, the various smaller tributaries of this AOI suffer from degradation due to AMD, urban runoff, and agriculture.



Photo by Jacobs Creek Watershed Association

*Wetland mitigation site in Jacobs Creek watershed*



### Youghiogheny River AOI:

Known locally as the Yough, and known nationwide as a scenic and recreation-focused river, this stream flows between steadily-developing Rostraver Township and predominantly rural South Huntingdon Township on its way to meet the Monongahela River at McKeesport, Allegheny County. The 47 square mile AOI takes into account the land in the Rostraver area draining directly into the Yough in the southwest corner of the county, and the smaller streams, including Cedar Creek and Pollock Run which serve to carry stormwater from the many residences and commercial areas of the township.



Photo by Downtown West Newton Inc.

*Youghiogheny River from Route 136 bridge, looking downstream.*

### Indian Creek AOI:

Located in the far southeastern corner of Westmoreland County, Indian Creek begins high on Laurel Mountain near where the Pennsylvania Turnpike crosses the ridge into Somerset County. Despite paralleling the heavily-traveled Turnpike for several miles, Indian Creek is classified as a High Quality stream and supports a strong fish population. Historically, the Indian Creek watershed has been dominated by resource extraction—timbering, quarrying, coal mining, and oil & gas production are all found here. In recent years the Mountain Watershed Association has created facilities to treat abandoned mine drainage (AMD) and has also established the Indian Creek Valley Trail, following the path of the former Indian Creek Valley Railroad. Recreational uses of water have become quite important in this area as many tourists visit the area for camping, hunting, fishing, and skiing.

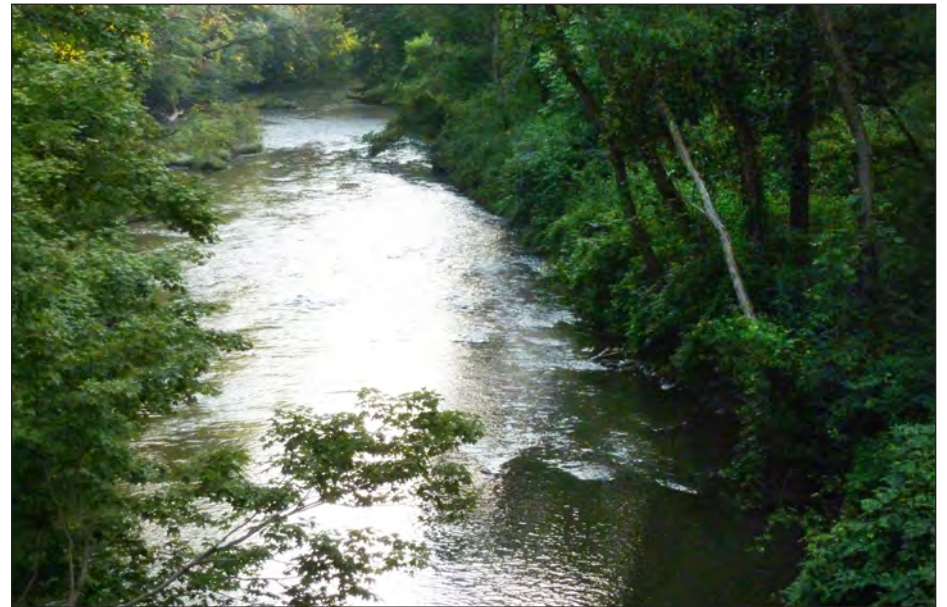
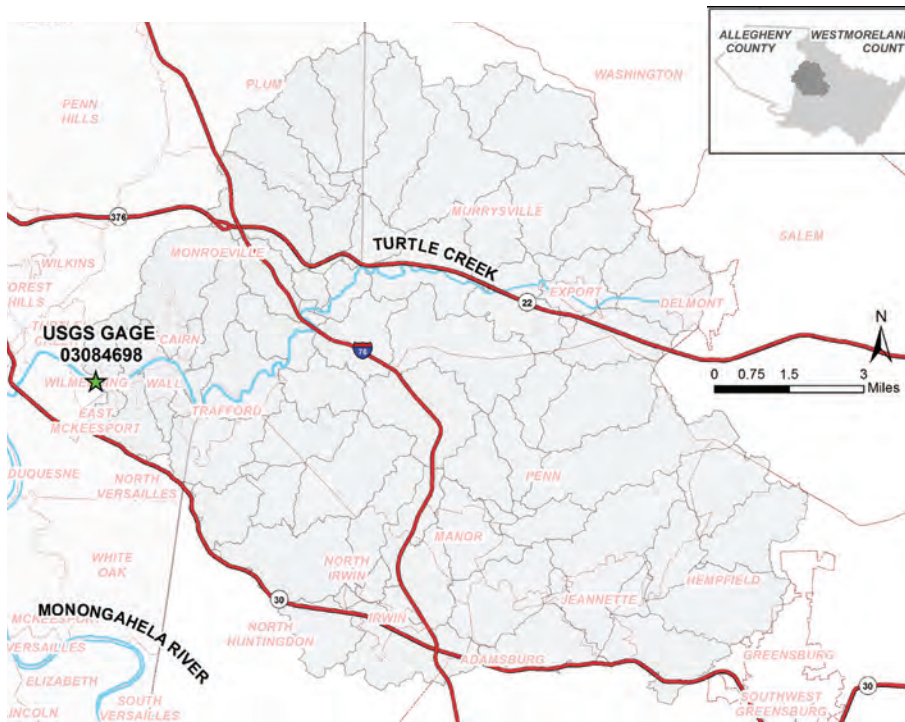

Photo by Stephen Simpson

*Indian Creek*

# TURTLE CREEK WATERSHED AREA OF INTEREST



Source - Ethos Collaborative

## REGION OVERVIEW

The Turtle Creek Area totals 147 sq mi and is located in both Allegheny and Westmoreland Counties, as shown on the map to the left. The Area of Interest for this watershed was defined as the land within Westmoreland County that drains to the USGS gage (# 03084698, located in Wilmerding and marked by a star on the map, left). This Area of Interest is approximately 98 mi<sup>2</sup>/ 62,720 acres and contains 227 miles of streams in Westmoreland county. For purposes of this plan, however, we modeled the entire region that drains to the Wilmerding USGS gage, an area which spans both Allegheny and Westmoreland Counties. The entire watershed draining to the Wilmerding USGS gage measures 123 mi<sup>2</sup> /78,724 acres in size and contains 268 stream miles. Turtle Creek continues downstream from Wilmerding, emptying into the Monongahela River in East Pittsburgh.

## Why is this watershed of particular interest?

The Turtle Creek watershed boasts an illustrious energy, industrial and commercial legacy. This watershed is the original home of the Westinghouse Electric Corporation, an early innovator in developing electric power generation infrastructure. Local coal mines provided fuel to power the factories. However, this same success has also left the Turtle Creek watershed with a legacy of pollution, industrial landscapes and impacted waters. This watershed was identified in Phase I as an area experiencing growth, recurrent flooding, and rapid development.

## Assets in the Watershed

The watershed currently has an Act 167 Plan from 1990, our county's only previous Plan. It is updated by this 2019 county-wide Integrated Water Resources Plan. The Turtle Creek Watershed Association maintains an active agenda of conservation, education, and partnerships to increase water quality through conservation and research management efforts addressing erosion, stormwater, sewage, and abandoned mine drainage. Please see <http://www.turtlecreekwatershed.org> for more information about their initiatives and programs.

## WATERSHED SNAPSHOT

- **Area:** 98 square miles
- **Water Quality:** Impaired for aquatic life, due to a myriad of pollution sources but primarily non-point sources of runoff from the landscape.
- **Characterization:** Highways provide relatively quick transportation from this largely suburban area into the city of Pittsburgh.
- **An active Watershed Association in this area is working to address problems such as Abandoned Mine Drainage and excess stormwater.**



## Turtle Creek Watershed Land Cover Classification

### Landcover / Landuse

Landcover in the Turtle Creek Watershed is mixed forested, agriculture, and urbanized land. The most highly urbanized areas include a swath of towns along the north/west boundary of the watershed (for example, Monroeville and formerly industrial areas such as Wall, Wilmerding, and Pitcairn) and another region along the southern border of the watershed (Irwin, North Huntingdon, Jeannette). The agricultural land is concentrated in the East and South regions of the watershed. Landcover data is based on the 2011 National Land Cover Dataset, created by the Multi-Resolution Land Characteristics Consortium (MRLC). Refer to [www.mrlc.gov](http://www.mrlc.gov) for methodology.

Landcover Class	Acres	Total Area (%)
Open Water	22	0.03
Developed- Open Space	10310	13
Developed- Low Intensity	12560	16
Developed- Medium Intensity	6407	8
Developed- High Intensity	1750	2
Barren Land	117	0.2
Deciduous Forest	37976	48
Evergreen Forest	230	0.3
Mixed Forest	63	0.08
Herbaceous	81	0.1
Hay/Pasture	8272	10
Cultivated Crops	916	1

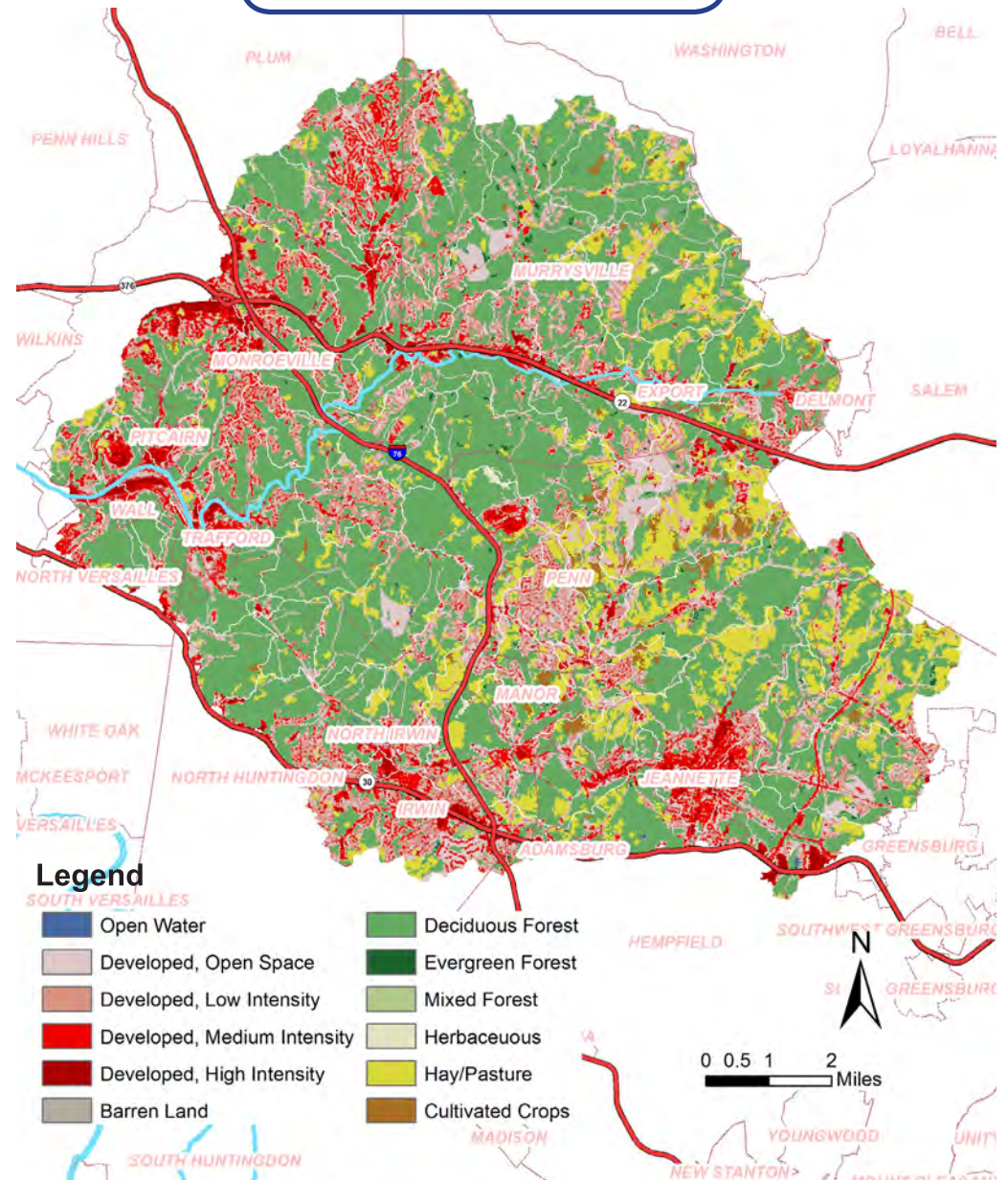

Source - NLCD 2011

## CURRENT WATER QUALITY IN THE TURTLE CREEK WATERSHED

### Non-point source pollution

In all, the Pennsylvania Department of Environmental Protection identified 85.8 stream miles as “attaining” their designated uses of providing a potable water supply and supporting aquatic life, 183.3 stream miles as “non-attaining,” and the remaining are unclassified. Identified impairment sources include Abandoned Mine Drainage, Agriculture, Urban runoff, and Erosion. Identified impairments include streamwater that contains metals, silt, high or low pH, nutrients and poor habitat quality. These are non-point sources, sourced not from one point source but instead from diffuse sources across the landscape.

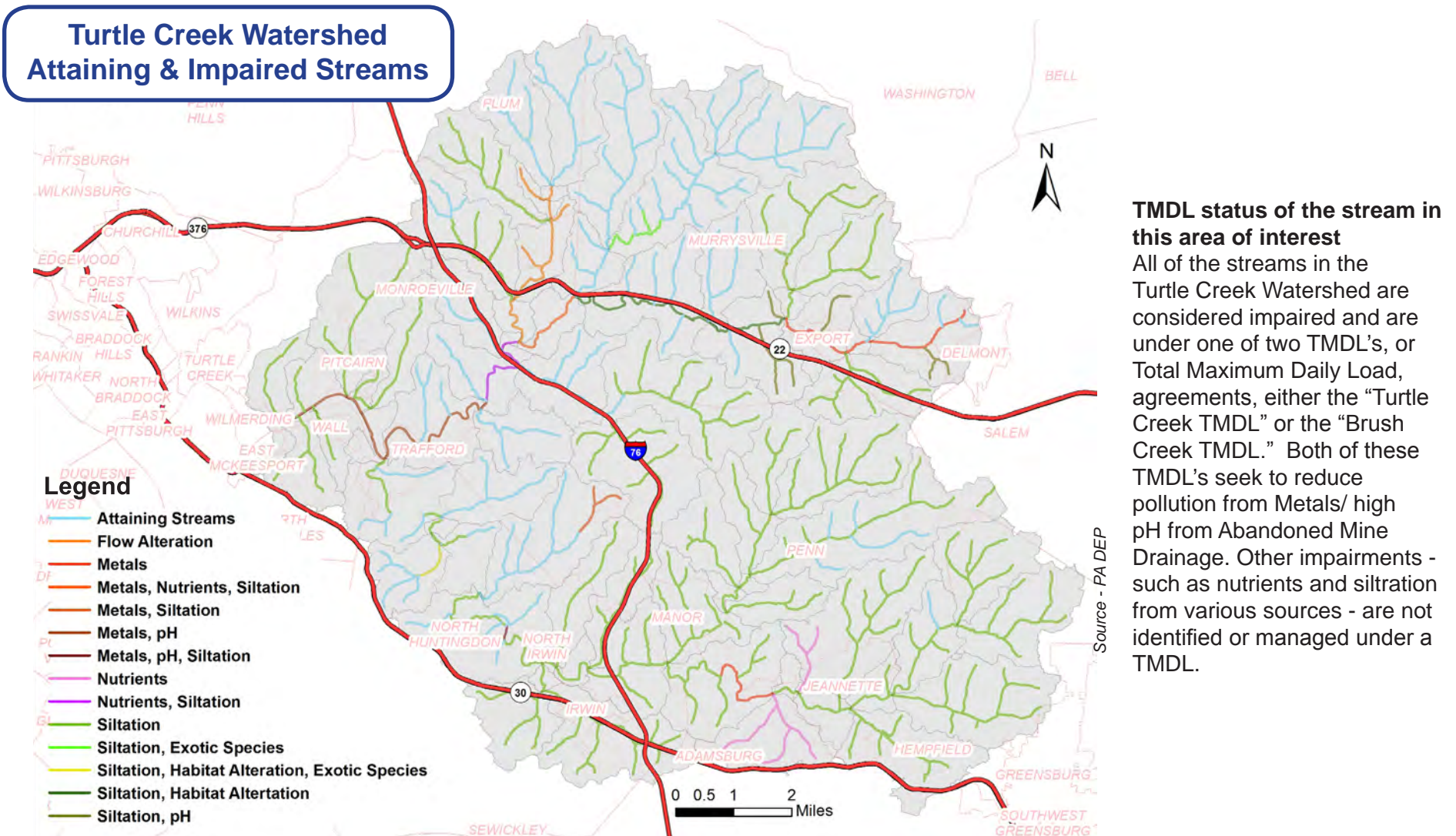



## Turtle Creek Watershed Impervious Cover

### WATER QUALITY AND WATER QUANTITY ARE INEXTRICABLY LINKED IN THE TURTLE CREEK WATERSHED

As water accumulates and moves overland on impervious surfaces, it picks up pollutants from the surface of the landscape and delivers it to receiving waters. Development, particularly that which increases impervious surfaces on the landscape, increases the overland flow of water during storms and decreases infiltration to groundwater. Increased stormwater also increases the erosive force of overland flow, increasing sediment load and delivering it to downstream receiving waters. Here, a watershed map shows the concentration of impervious surface in the industrial/commercial areas.

As stormwater runoff increases, so does the water's capacity to carry sediment and nutrients such as Nitrogen and Phosphorus. Stormwater may drop sediment and pollutants when the flow/energy of the water decreases.

Both the sediment and the pollution are a threat to water. Accumulated nutrients can lead to harmful algae blooms, which may affect wildlife and water quality in receiving waters. The sediment accumulation represents the erosion and loss of valuable soil from upstream landscapes. The sediment is also a future threat as it continues to accumulate and potentially creates sandbars or other debris features in the receiving water body.

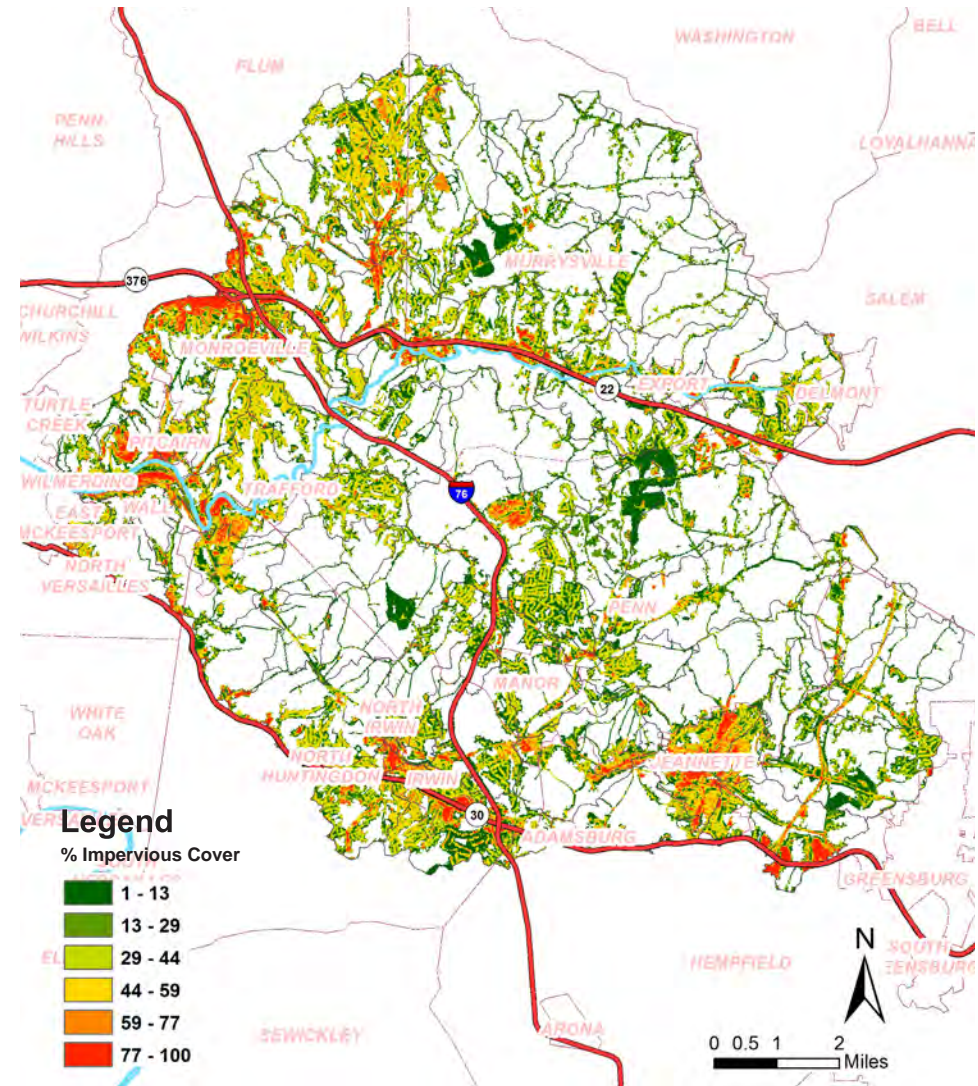



## FUTURE TRENDS IN THE TURTLE CREEK WATERSHED

This watershed will likely see increasing development and a reduction in forested and agricultural land. These land-use trends will likely add to stormwater runoff and non-point pollution loadings. There is tremendous opportunity to carefully

plan now in order to mitigate the potential increase in flooding and pollution delivery downstream. The projections below are compiled from the ESRI GREEN INFRASTRUCTURE Online Mapping tool, developed in conjunction with the Clark Labs (<http://www.esri.com/about-esri/greeninfrastructure>).

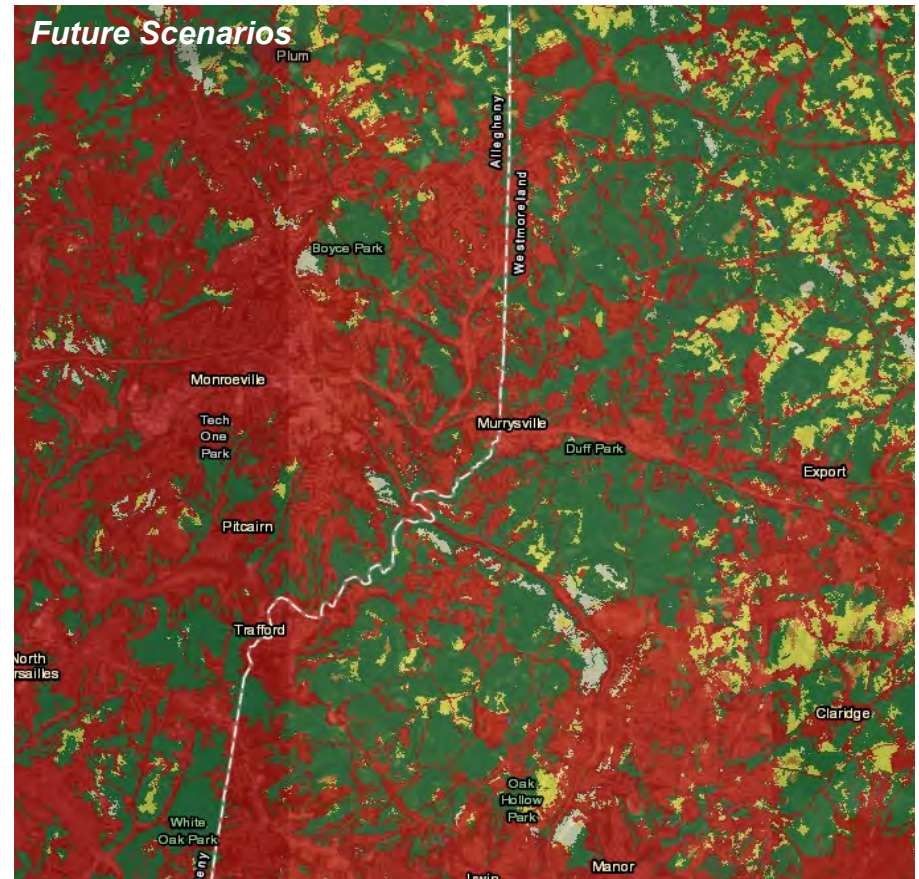
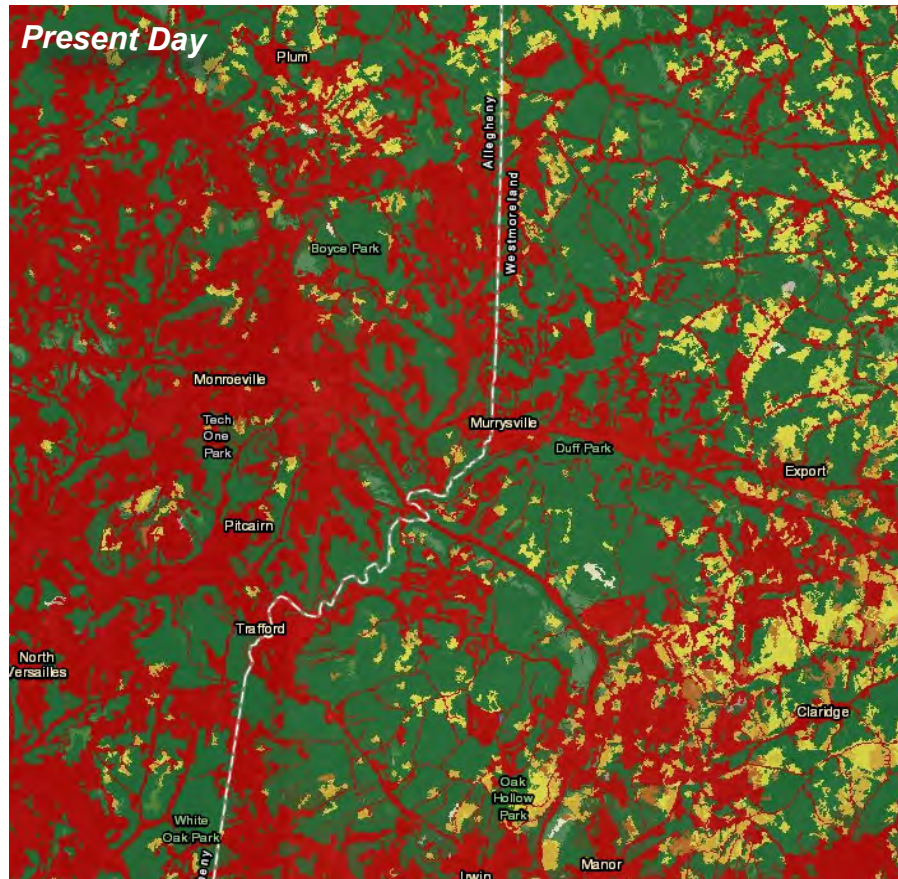

### Legend

#### National Land Cover Database

 Open Water	 Grassland/Herbaceous
 Perennial Ice/Snow	 Pasture/Hay
 Developed	 Cultivated Crops
 Barren Land (Rock/Sand/Clay)	 Herbaceous and Woody Wetlands
 Forests	
 Scrub/Shrub	

### Specific predictions of change in land-use

Above, a visual comparison of land use in 2011 versus predicted land use in 2050 highlights the forecasted increase in impervious surfaces. This analysis of land use change in the Turtle Creek Watershed specifically estimates

- A 25% *INCREASE* in developed land
- A 20% *DECREASE* in forest cover
- A 38% *DECREASE* in agricultural cropland

Source - ESRI



## HYDROLOGIC WATERSHED MODELING:

### INPUT PARAMETERS, MODEL CALIBRATION & FINAL RELEASE RATES FOR THE TURTLE CREEK WATERSHED

Controlling water now and in the future requires an understanding of current conditions and pollution sources. The Parameters below and on the following pages were used in hydrological models to help us understand the contribution of different sub-watersheds to the flow of the whole, and possible future changes.

**Hydrologic Soil Groups in the Turtle Creek Watershed** The map below is color-coded by the Hydrologic Soil Group, which indicates a soil's water holding capacity. Group A soils have low runoff potential and high infiltration rates, while Group D soils show the highest runoff potential with very low infiltration rates. Also shown are the specific soil names, please see appendix for a list and descriptions of individual soil types.

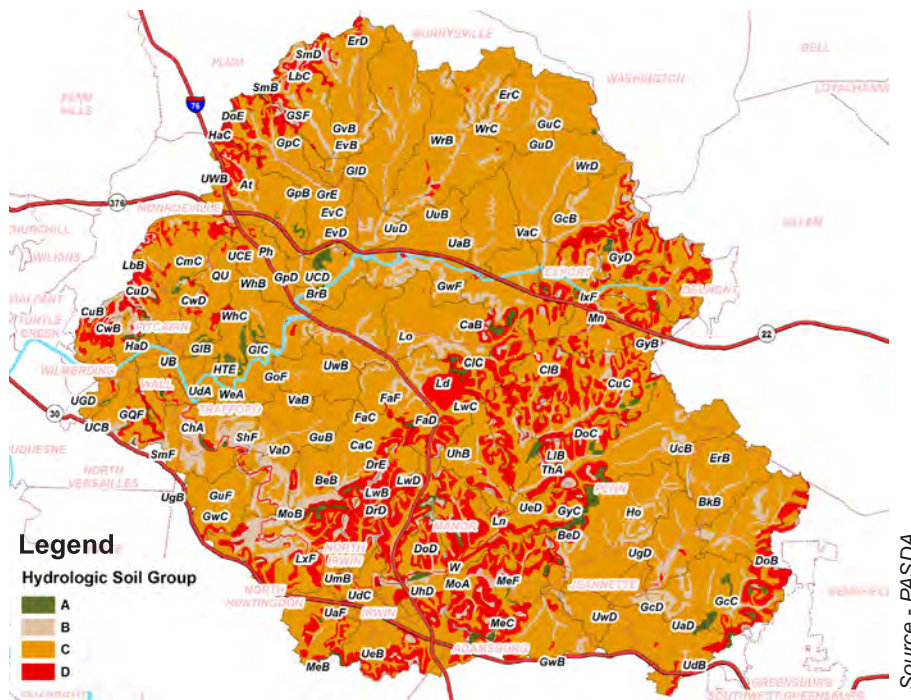

**Basin Curve Numbers ("CN's") in the Turtle Creek Watershed** are an empirical parameter that help predict direct runoff/infiltration from a parcel of land during a rain event. In the Turtle Creek Area of Interest, these range from 68 to 86. Watersheds with a higher curve number indicate higher runoff potential, leading to greater flooding and pollution delivery to streams. Regions with more impervious surface generally have a higher CN value.

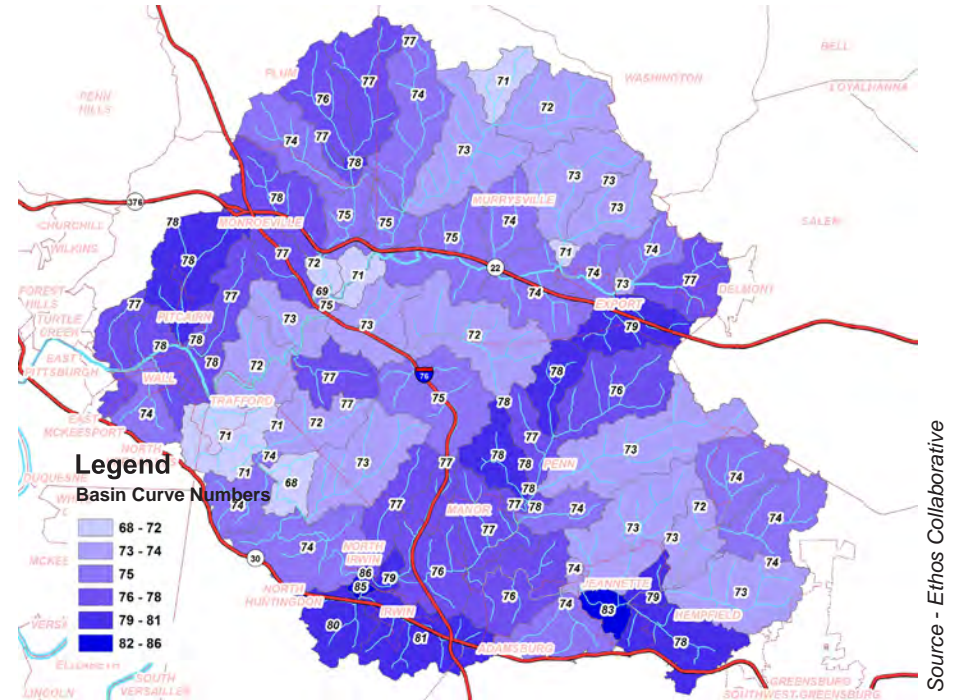



### Average Basin Slope (%) in the Turtle Creek Watershed

Generally most regions in this watershed show a moderate slope, with an average sub-basin slope ranging from 11 range of values from 11.82% to 33.15%. Steeper slopes are found in the stream valleys and shallower slopes on the upland regions. Slope steepness contributes to overall runoff calculations, as steeper regions generally experience greater runoff during rain events.



**The Basin Storage Ratio in the Turtle Creek Watershed** indicates the proportion of each sub-watershed that can store water. Storage areas include lakes, ponds and floodplains. Storage ratios range from 0.0008 to 0.1999, therefore the storage amount available in each sub-watershed varies from 0.08-20 of the sub-watershed area. Greater storage in a sub-watershed indicates a region that can absorb/store more water in a storm, instead of directly increasing stream discharge.

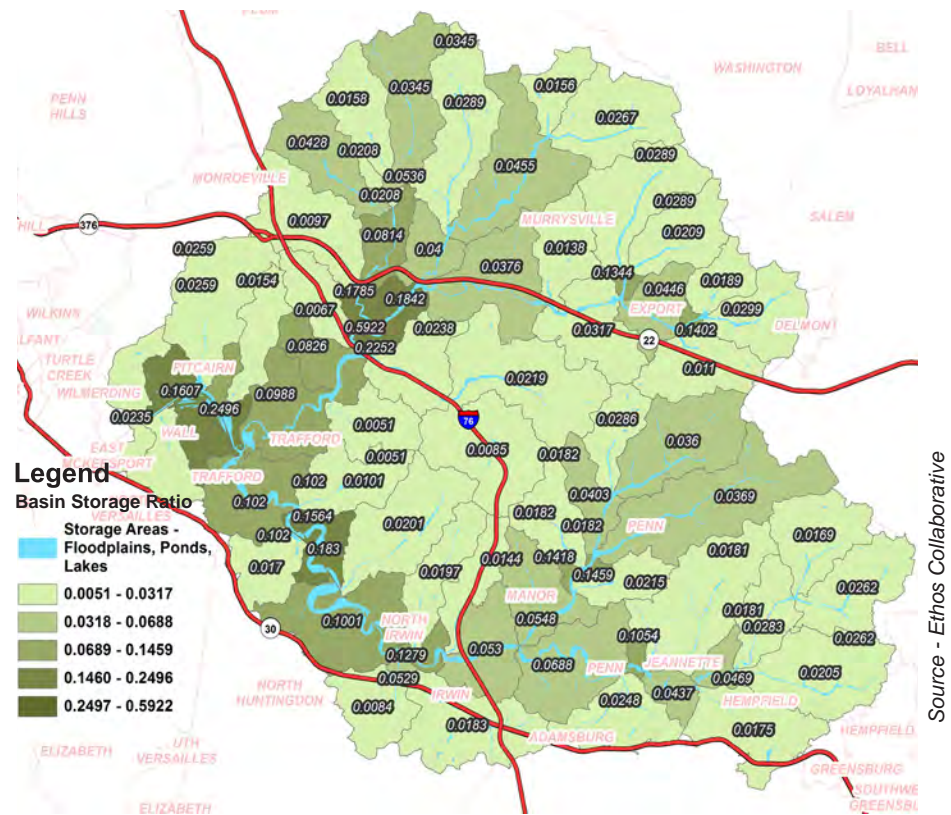

Source - Ethos Collaborative



## MODEL CALIBRATION IN THE TURTLE CREEK WATERSHED

The USGS gage (03084698) in Wilmerding provided an accurate basis for calibration of the HEC-HMS model results in the Turtle Creek Watershed. In addition, ten sites were chosen as “areas of interest,” and model results at these sites were compared to Stream Stats data for the same sites. This approach allowed the

calibration of hydrological models, in the absence of multiple stream gage locations in the watershed. Calibration sites were located at important stream junctions throughout the watershed. Individual sites are designated with “J”, below.

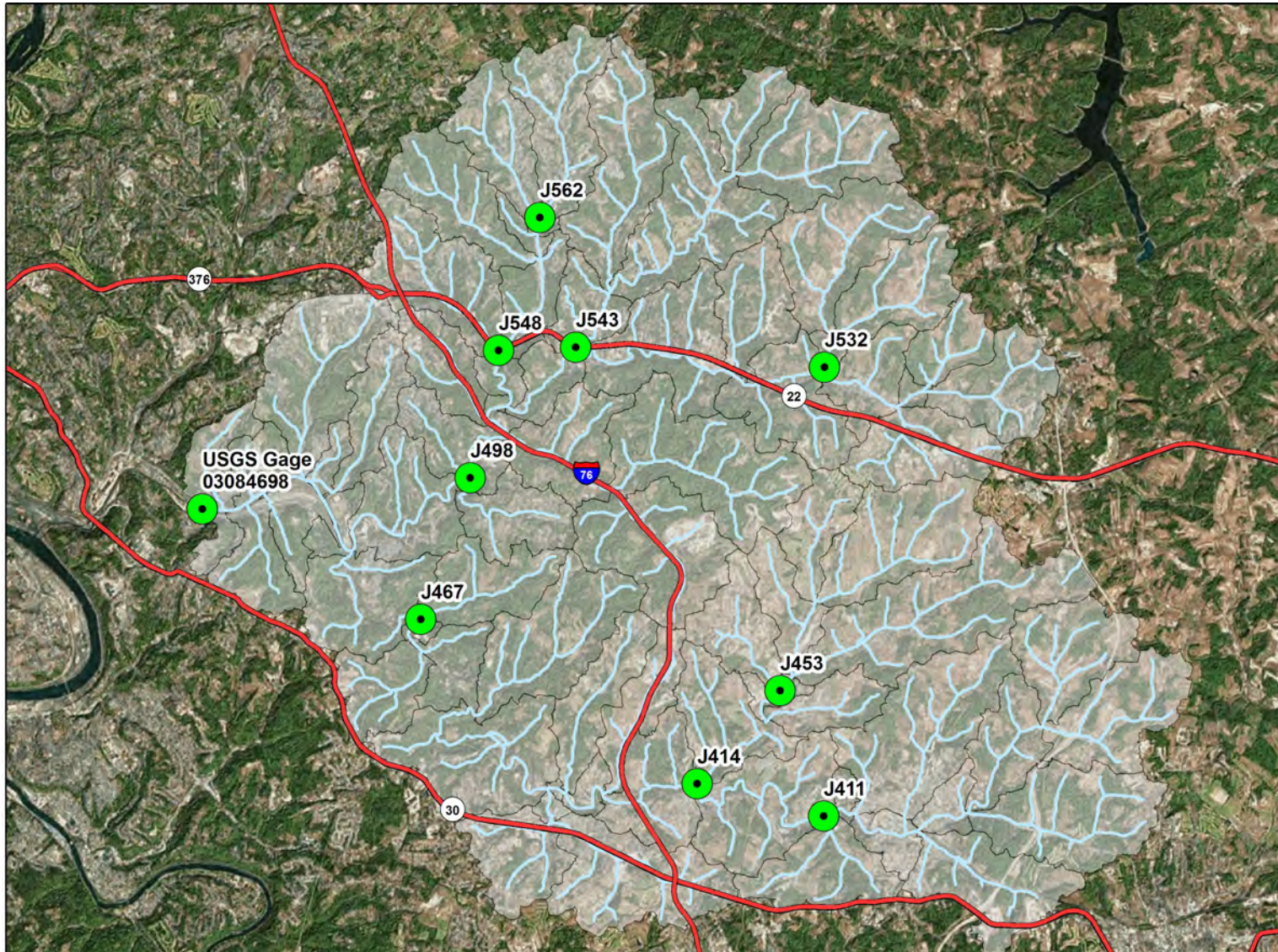

Source - Ethos Collaborative



## CALIBRATION AND VALIDATION:

### Comparison between modeled discharge and measured discharge for design storms

The availability of USGS discharge measurements for the Turtle Creek gage at Wilmerding provided solid data to calibrate and validate the HEC-HMS models. Below, modeled versus measured discharge (CFS) for 2, 5, 10, 25, 50, and 100 year storm events provide evidence that the model estimates large flows well, when compared to measured large flows.

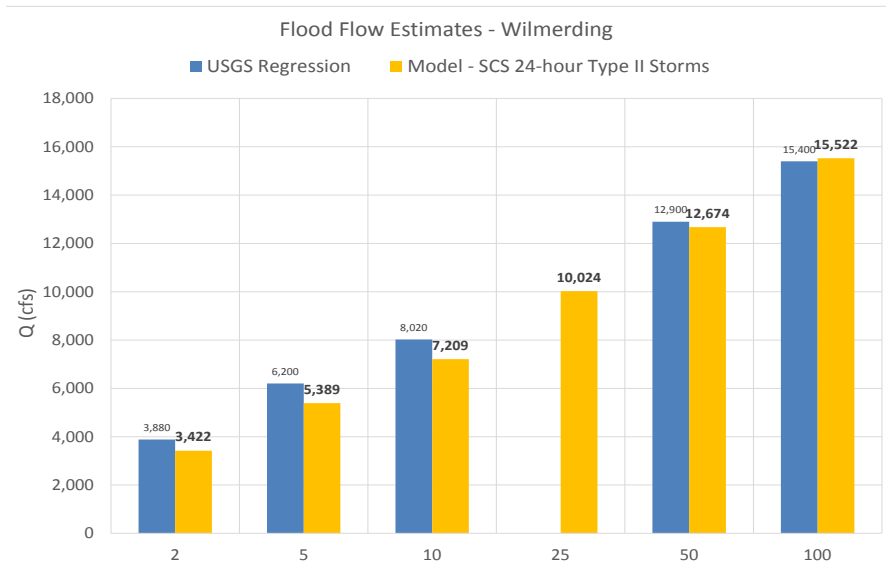

Source - Ethos Collaborative



Turtle Creek

## STATISTICAL COMPARISON:

### Model Results versus Gage Results for Specific Storm Events

Statistical evaluation of individual storms allowed us to quantify the degree of difference between model results and measured data.

- **Pearson's Correlation Coefficient ( $r$ )** measures the strength of a relationship between two variables. The " $r$ " values shown below indicate a very strong positive relationship between modeled and measured discharge values.
- **Percent Bias (PBIAS)** calculates the difference between the mean (average) of the model versus the gage data. In general, it provides an estimate of how the model over or under predicts the actual data.
- **Nash-Sutcliffe efficiency (NSE)**, assess model accuracy, where the closer the NSE is to 1, the closer the model is to actual data. In the chart below, the calculated NSE ranges from 0.97 to 0.40.

Event	Pearson's Correlation Coefficient ( $r$ )	Percent Bias (PBIAS)	Nash-Sutcliffe efficiency (NSE)
Ivan 2004	0.99	-4%	0.97
June 2013	0.98	0%	0.95
July 2013	0.97	-28%	0.88
Sandy 2012	0.93	8%	0.87
August 2007	0.93	3%	0.85
January 2005	0.99	0%	0.98
January 2013	0.95	-15%	0.88
December 2008	0.95	-10%	0.85
November-December 2010	0.99	59%	0.40
December 2012	0.95	-5%	0.90

Source - Ethos Collaborative

When combined with the actual storm hydrographs (right), these statistical parameters help to define the degree to which HEC-HMS over or under-predicts the data. For example, the hydrograph for the July 2013 storm (right) shows that the blue modeled data line is largely under the red gage line. The " $r$ " value for this storm indicates good correlation between the data. The Percent Bias of -28% indicates that the model is under predicting, and the NSE is 0.88, again suggesting overall that the model achieves a good degree of accuracy.



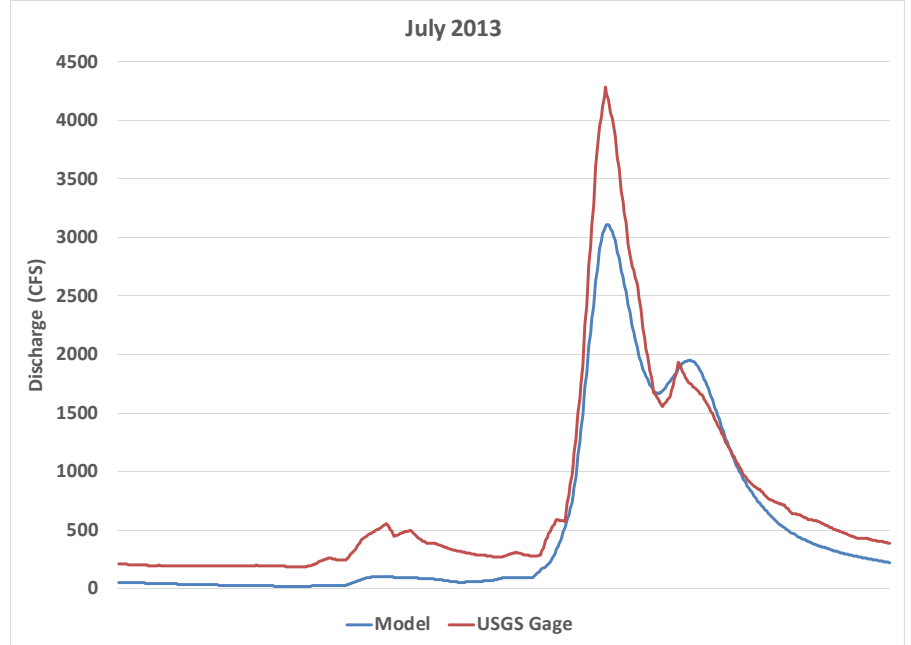
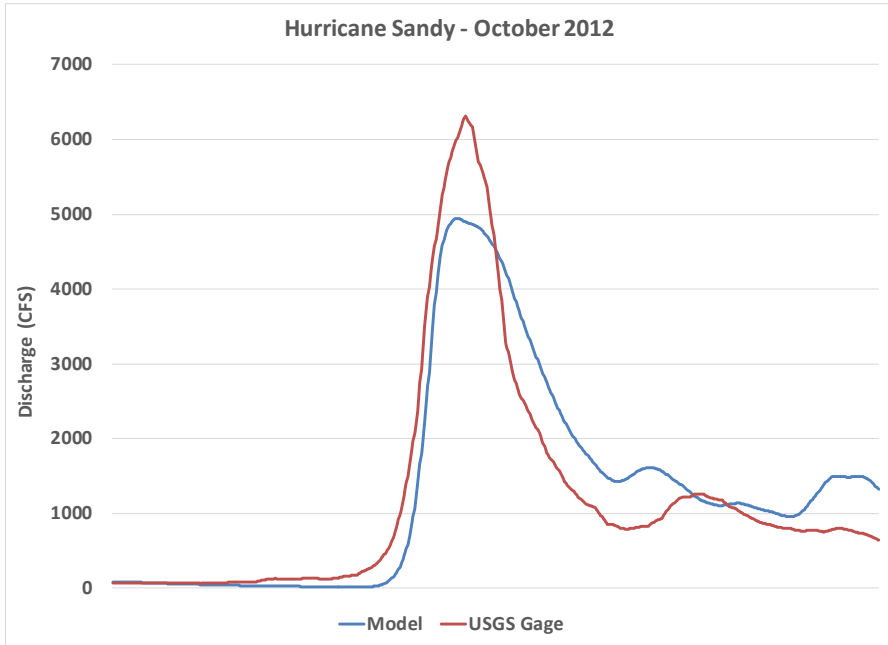
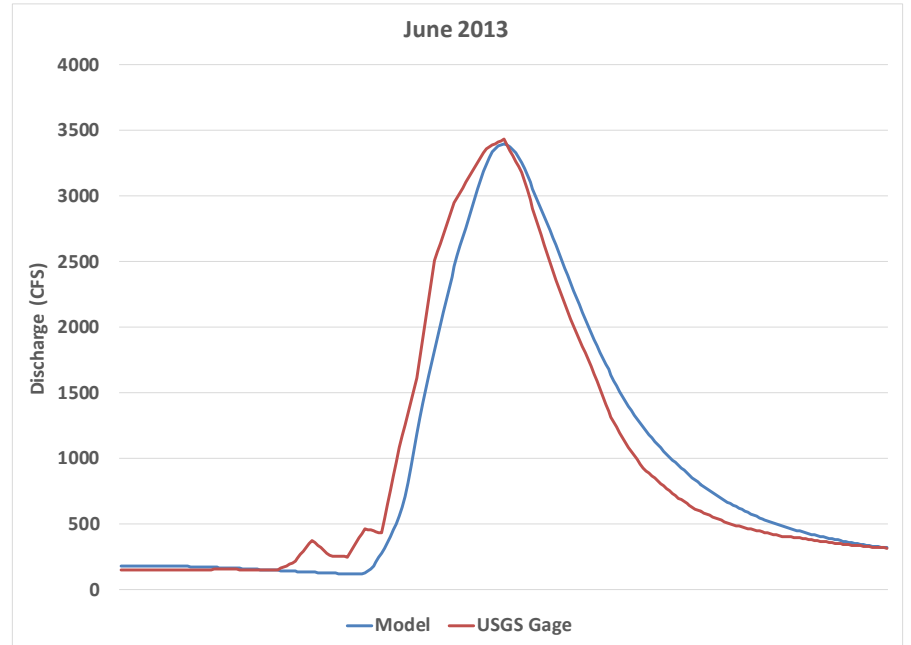
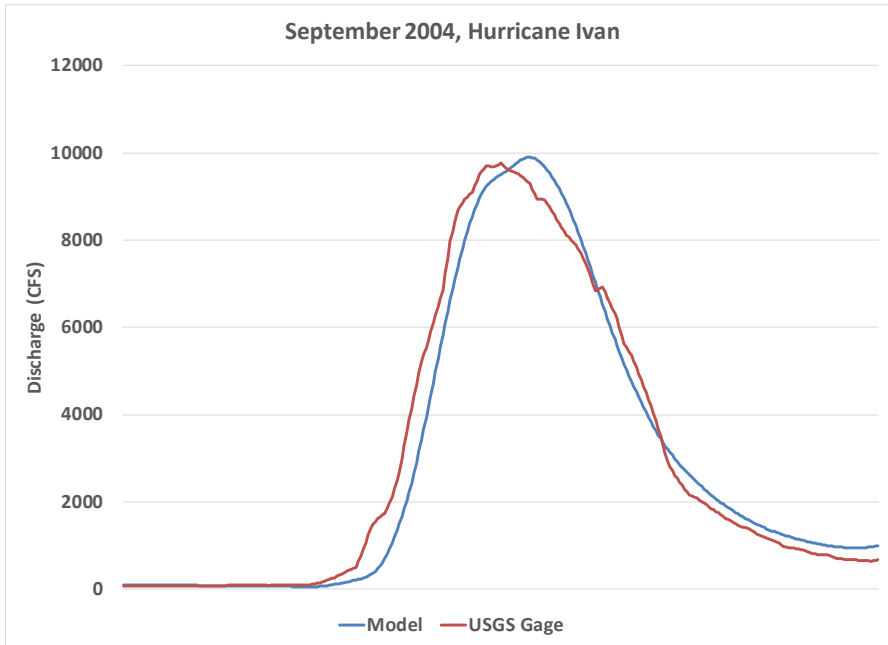

## COMPARISON BETWEEN STREAMSTATS AND MODEL RESULTS

In the Turtle Creek watershed, we first used the gage data to validate and calibrate the HEC-HMS model. We then compared the results from the HEC-HMS model to StreamStats for different stream reaches. This allowed us to determine the feasibility of using StreamStats discharge data, in the absence of gages throughout the watershed. This was particularly important in watersheds without stream gages installed in them.

The graphs below show how StreamStats and the hydrological model discharge results compare for the 2, 5, 10, 50, and 100 year storms. There is a good correlation between model results and Streams Stats data, which suggests this is a reasonable approach to the lack of discharge data in other watersheds.

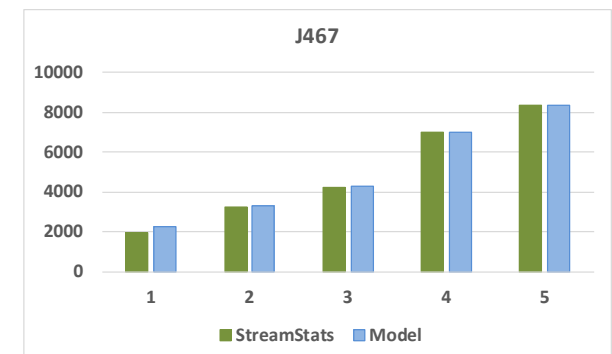
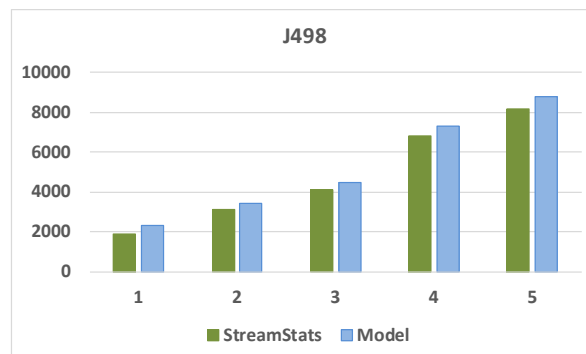
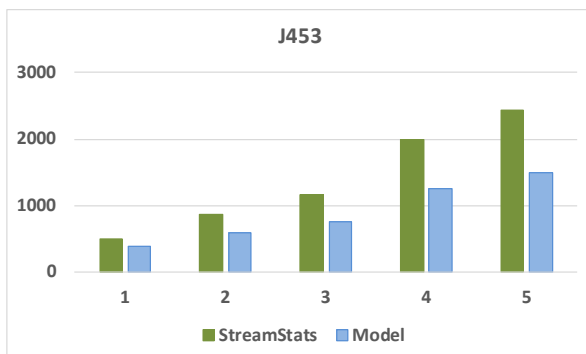
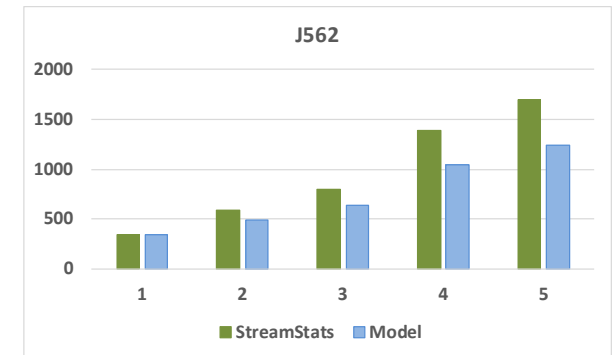
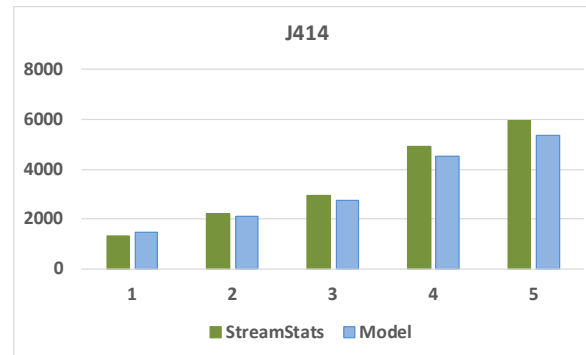
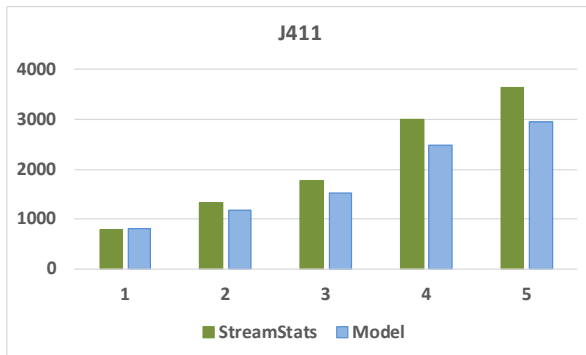
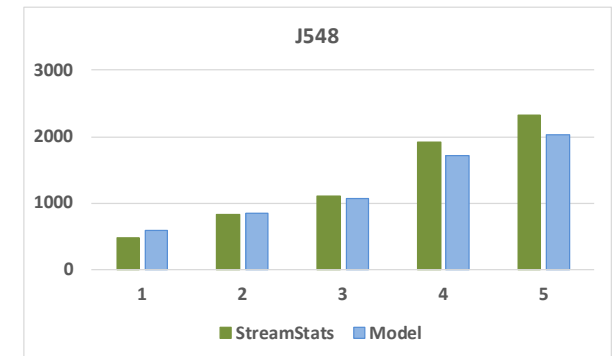
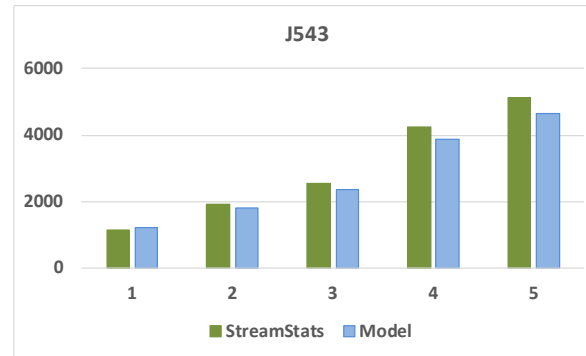
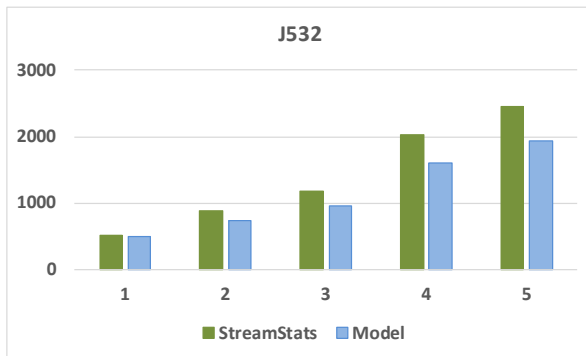
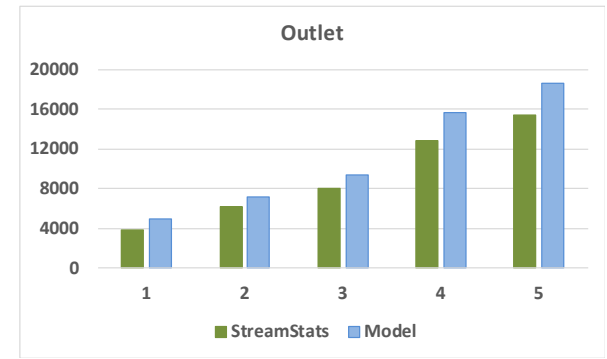



## RECOMMENDED RELEASE RATE MAP FOR THE TURTLE CREEK WATERSHED AREA OF INTEREST

Release rates are a tool that help determine the timing of when water can be released from a watershed. Final calculated release rates are shown to the right. Darker colors and lower release rates indicate regions where future development must reduce runoff rates.

A release rate of 50% for a sub-watershed indicates that the rate at which stormwater moves out of the watershed and downstream must be reduced by half (50%) in any future development.

In contrast, a release rate of 100% indicates that, with future development, stormwater can move off of the sub-watershed at the same rate that it does in the present. In other words, lower release rates require an increased control of runoff.

Release rates were calculated based on a hydrologic model of the area of interest using HEC-HMS, the U.S. Army Corps of Engineers (USACE) Hydrologic Modeling System, in conjunction with GEO-HMS (a GIS extension that allows for the manipulation of spatial data).

The methodology to calculate release rates focuses on the basin-wide contribution of upstream land on downstream flooding. In order to control more localized flooding, individual municipalities may enact stricter stormwater runoff controls.

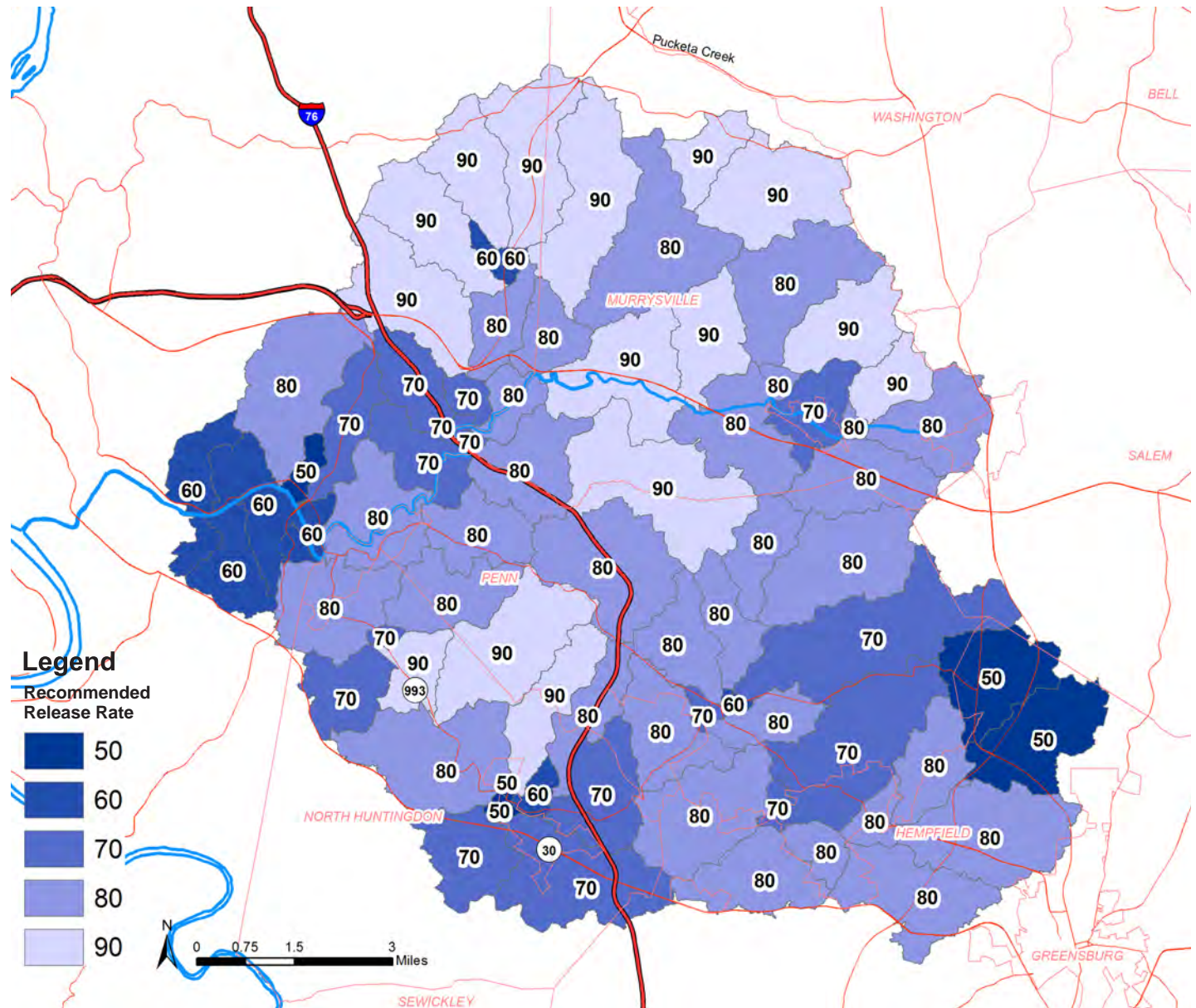

Source - Ethos Collaborative / WCD



## LANDSCAPE POLLUTION ACCUMULATION MODELING

To understand where and how pollution-bearing runoff moves across the landscape, we modeled accumulation using ArcGIS in conjunction with a specialized terrain analysis toolset, (TAUDEM). This analysis allowed us to understand both pollution contributions and pollution reductions due to the underlying landscape. Please see the Methodology Appendix for further details about this process.

### TOTAL SUSPENDED SOLIDS (TSS)

Sediment, or Suspended Solids, encompasses any number of particulate pollutants or natural particles, from a myriad number of sources. Shown below is the estimated sub-watershed export of sediment, in pounds per year.

- Impervious surfaces collect solids during dry weather and then during wet weather contribute to high TSS loads draining from these watersheds. These regions have little in the way of riparian buffers or other landscape features that help to slow, infiltrate, and absorb water.
- Significant contributions of TSS are also found in sub-watersheds where agricultural activities such as grazing and plowing take place. These regions in particular would benefit from the increase in riparian buffers as a way to capture water and associated pollutants before it reaches the stream.

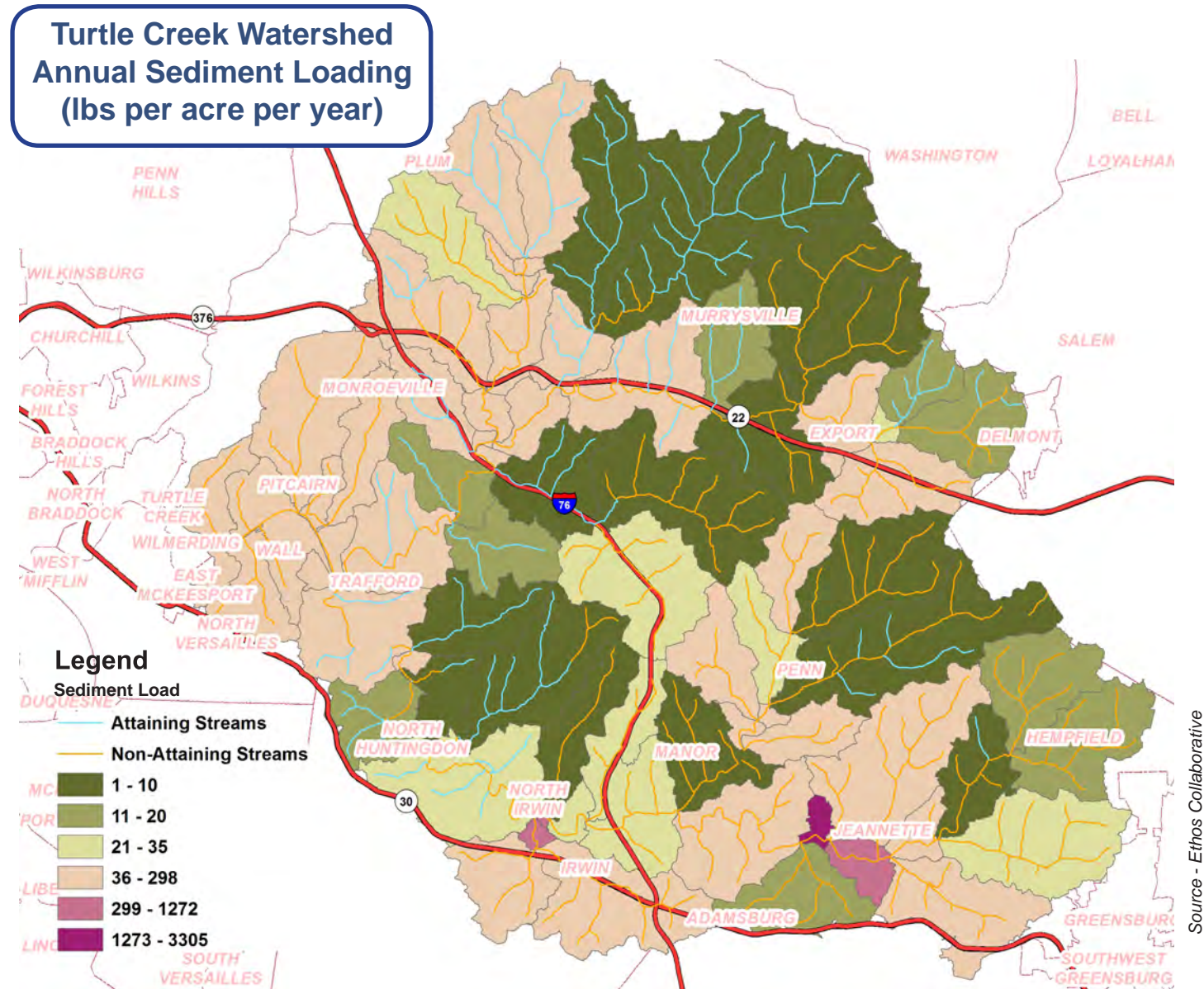

Source - Ethos Collaborative



## NITRATE (NO<sub>3</sub><sup>-</sup>)

Nitrogen, here expressed as nitrate (NO<sub>3</sub><sup>-</sup>), is a nutrient essential for plant and animal growth. Historically, biologically available nitrogen was a limiting factor in ecosystems, however industrial activities have increased biologically available nitrogen to the point where it is now considered a pollutant in many regions. Shown on the map to the right is the modeled sub-watershed export of nitrate, in pounds per year.

- Agricultural activities and residential areas both contribute fertilizer-sourced nitrogen to the watershed. Fertilizer applied to croplands and residential lawns can be washed from the land surface into streams.
- Nitrogen can be found in urine excreted from grazing animals. Urine-sourced nitrogen is biologically transformed to nitrate, which can then be transported downstream.
- Fixed nitrogen is emitted to the atmosphere when fossil fuels are burned. This nitrogen is deposited as nitrogen oxides or NO<sub>x</sub>, on the landscape, with concentrations found in near-road areas.
- Wastewater contains biologically available nitrogen. Wastewater treatment plants may not remove all of the nitrogen before treated water is discharged to streams. Septic systems may contribute biologically available nitrogen to groundwater.

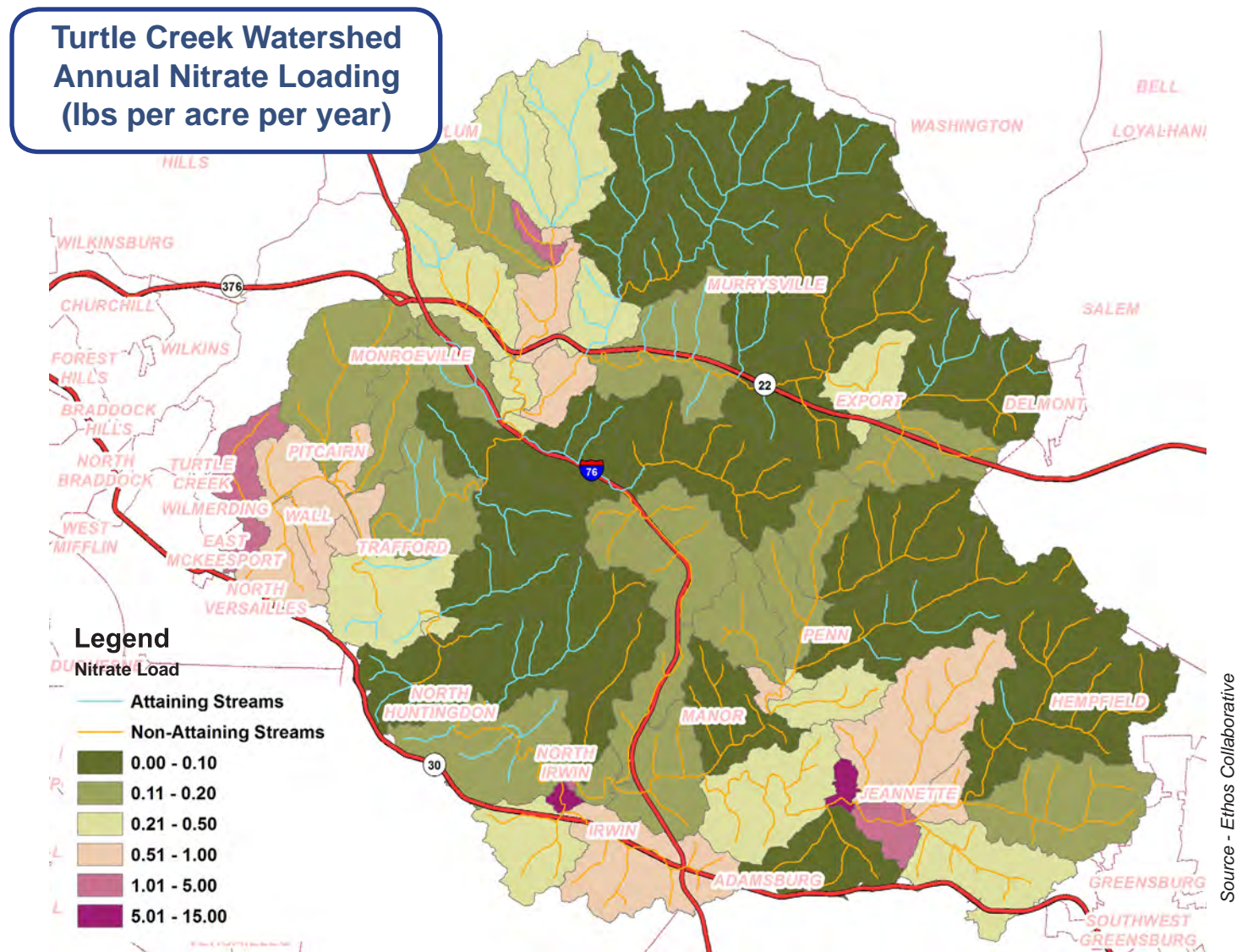

## TOTAL PHOSPHORUS (TP)

Phosphorus, here expressed as Total Phosphorus (TP) is a nutrient essential for life. Phosphorus, like Nitrogen, used to be a limiting nutrient, however industrial activities and fertilizer both contribute excess phosphorus to ecosystems. Phosphorus contributes to algae blooms in water bodies, eutrophication, and overall habitat deterioration. Shown on the map is the modeled sub-watershed export of TP in pounds per year.

- Higher amounts of phosphorus are exported from the urban sub-watersheds. Here, phosphorus is sourced primarily from lawn fertilizer and roadway deposition. These sources produce both particulate and dissolved forms of phosphorus.
- Soil erosion is another contributor of phosphorus to streamwater. Erosion depletes the soil of valuable nutrients like phosphorus and transports the nutrient downstream.
- Crops lands export Phosphorus to downstream environs, sourced from fertilizer applied to the fields. Fertilizer-sourced Phosphorus is likely in particulate forms, and therefore structural BMP's that filter and/or detain sediment and particles can help to mitigate downstream export.
- Wastewater contains phosphorus from human waste and detergents. Wastewater treatment plants may not remove all of the phosphorus before treated water is discharged to streams.

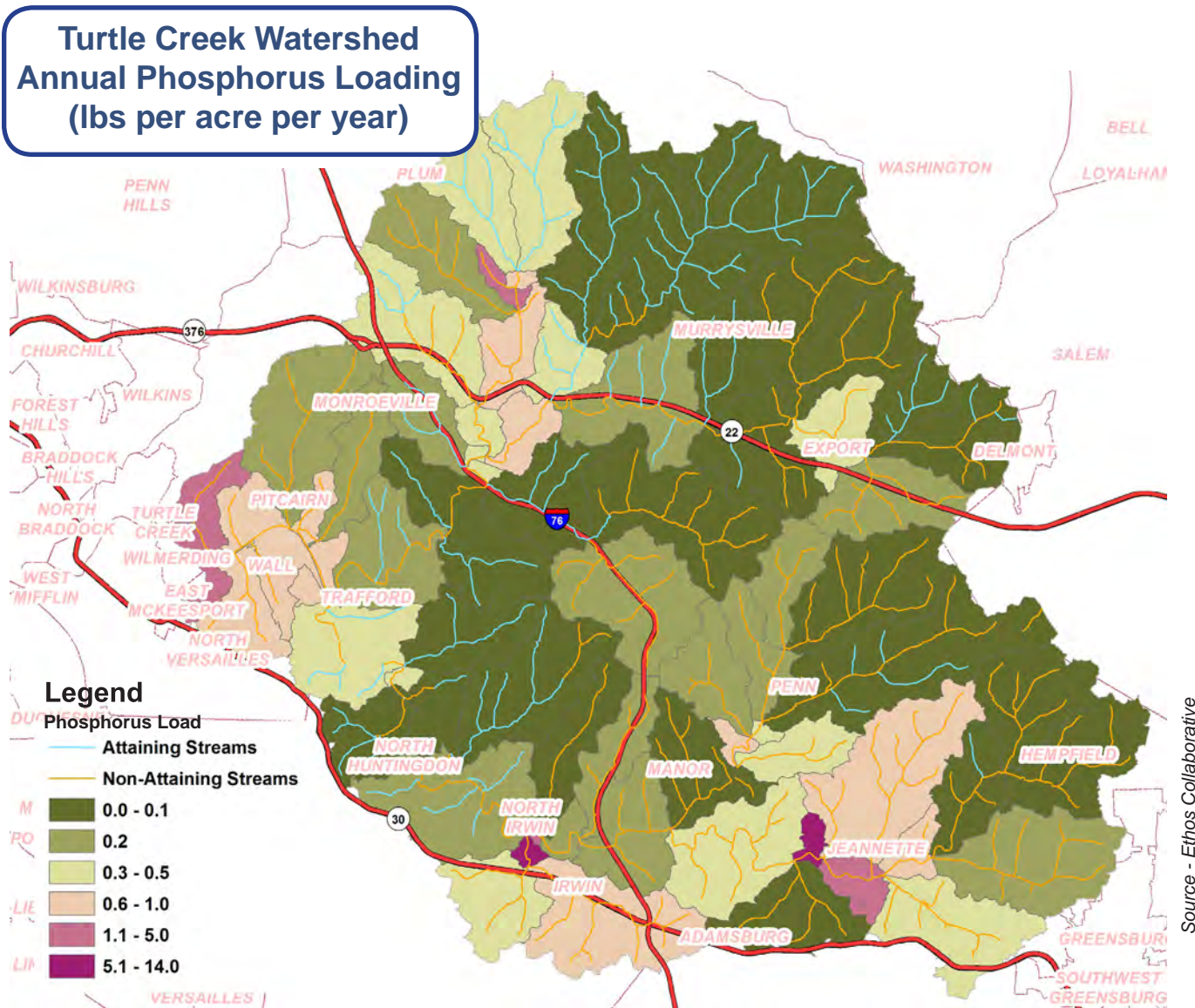



# OPPORTUNITIES FOR EFFECTIVE STORMWATER MANAGEMENT IN THE TURTLE CREEK WATERSHED

Based on Modeling Watershed Hydrology and Pollution Sources to Inform Smart Water Management:

## Effective water management protects valuable resources and built infrastructure.

The groundwater and rivers in this area serve as drinking water sources and support the local ecosystem. Effective stormwater management measures should consider ways water management that decreases soil erosion, sedimentation in receiving water bodies, and pollution reaching water bodies. Sensible, proactive water management also protects our built infrastructure, such as roads, buildings, and bridges, from destructive flooding.

## To increase water quality, we must decrease overland water flow.

As the overland flow of water increases, so does the load of pollutants and sediment downstream. Slowing and decreasing overland flow during a storm decreases downstream flooding and the

subsequent transport of water-borne pollutants. Water detained by increasing infiltration to groundwater also encourages retention, or the uptake and filtration of pollutants by biota and soil. Together, the processes of infiltration and retention increase water quality through decreasing erosion and downstream transport.

## Conceptual Ideas for BMP's/Landscape Restoration: Highlighting the potential for water and pollutant capture and retention.

The following are conceptual ideas and potential locations for Best Management Practices, or BMPs, at different points in the watershed. These potential sites were identified by local residents. It should be stressed that these conceptual ideas are not currently under consideration for any specific project. Instead, these highlight potential sites for restoration, based on relatively simple spatial analysis methods. These sites are located in the residential/commercial regions of the watershed, which export the bulk of the pollution.



Photo by Rob Cronauer

Westmoreland Heritage Trail along Turtle Creek - Before



Photo by Rob Cronauer

Westmoreland Heritage Trail along Turtle Creek - After



## Water Quality and Stormwater Issues in the Turtle Creek Watershed

Thirteen sites in the Turtle Creek Area of Interest with known stormwater or water quality issues are identified below. This list was compiled based on reports made by local property owners to the Westmoreland Conservation District and should by no means be considered an exhaustive list. Identified issues include untreated Abandoned Mine Drainage (AMD), stormwater runoff and associated

erosion, as well as the identification of sites appropriate for Green Infrastructure such as stormwater retrofits, riparian buffer restoration, and stream restoration. When coupled with the landscape-based nutrient accumulation and decay modeling, this list can help to identify and prioritize projects for future conservation efforts.

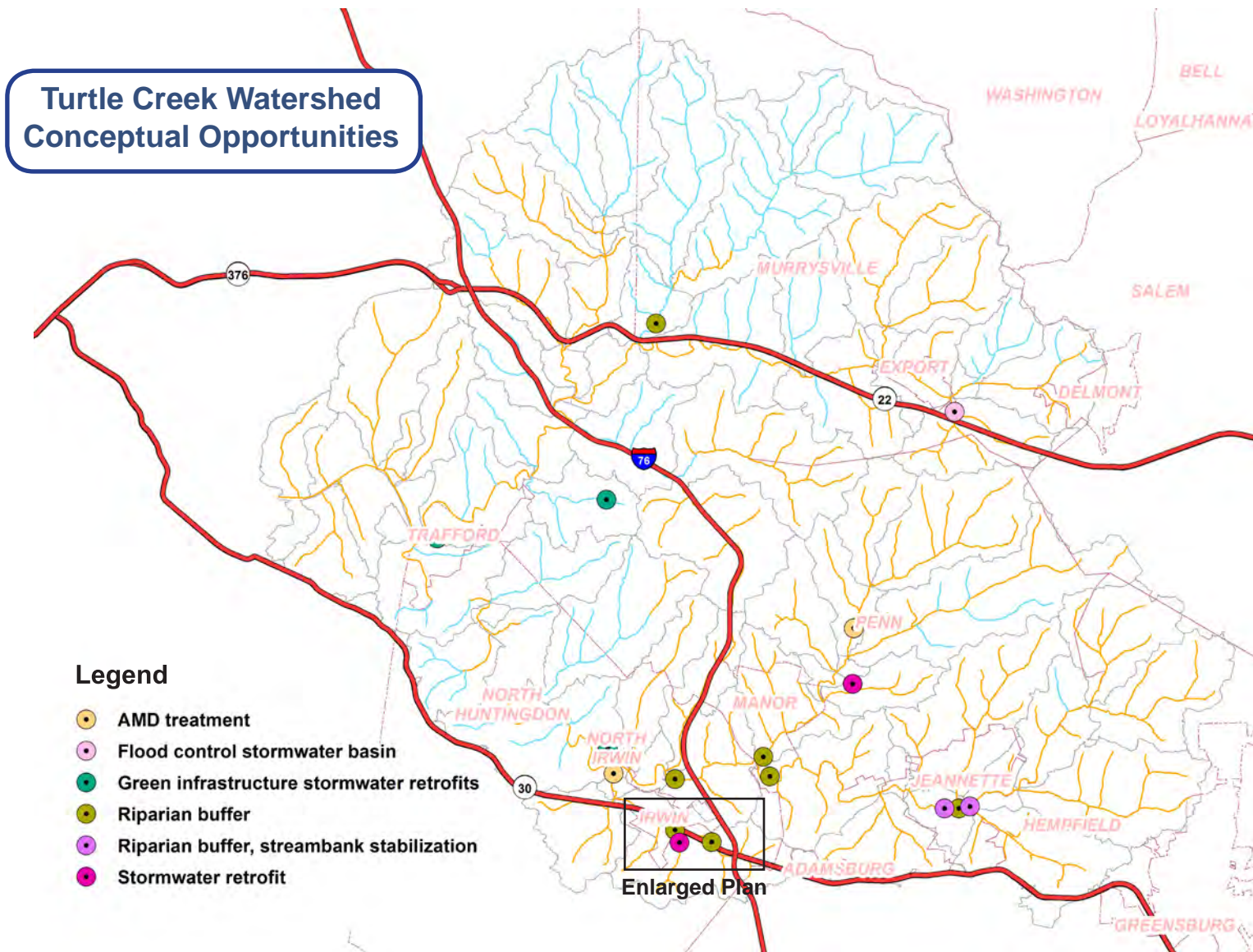

**Turtle Creek Watershed  
Conceptual Opportunities**

### Legend

- AMD treatment
- Flood control stormwater basin
- Green infrastructure stormwater retrofits
- Riparian buffer
- Riparian buffer, streambank stabilization
- Stormwater retrofit

Enlarged Plan



## CONCEPTUAL OPPORTUNITIES IN THE TURTLE CREEK WATERSHED: RIPARIAN BUFFER RESTORATION/STORMWATER RETROFIT

These three sites are located near the border of Irwin and North Huntingdon, along the commercial Route 30 corridor. The stream reach moving through this area drains a region with a high proportion of impervious surface.

### Water Quality Goals:

During rain events, water rushes from the impervious surfaces into storm sewers and the stream network. This water can increase downstream flooding, as well as deliver sediment and pollution including dissolved and particulate Suspended Solids (TSS), Phosphorus (TP), and Nitrate ( $\text{TNO}_3^-$ ).

### Stormwater Management Potential:

Identified needs include increasing the riparian buffer on above-ground portions of the stream and retrofitting an existing stormwater detention basin into a retention/infiltration basin.

### Landscape Elements to Consider:

The map above shows the area of interest, close-up. The above-ground stream portions are shown in blue, the stream sections that flow through underground storm sewers are shown in yellow. Green thickening lines show surface flow paths, indicating the accumulation of stormwater and pollutants flowing across the landscape and into streams. There is little tree canopy / riparian buffer between these pollution sources and the stream course.

### Water Quality Impacts of Stormwater Management:

Stream restoration efforts should focus on water quality improvement through slowing the water to encourage particle filtration/settling, water infiltration, and increasing biological processing interactions. This would help to decrease stream loads of TSS, TP and  $\text{TNO}_3^-$  that are contributed from the impervious surfaces. Restoring/augmenting the riparian buffer on both sides of the above-ground stream would help to mitigate the influx of nutrients and sediment.

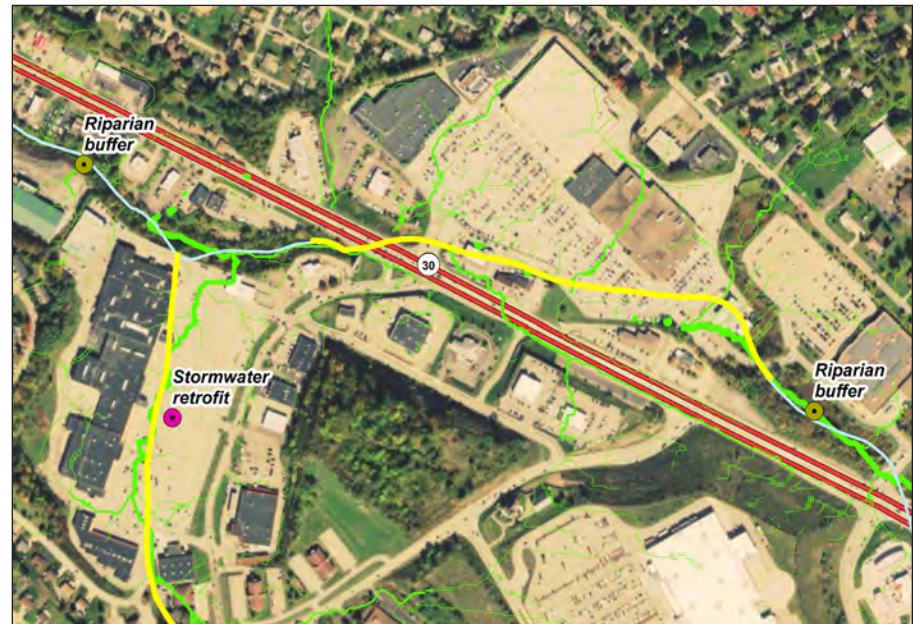

*Enlarged plan of opportunity sites*

Source - Ethos Collaborative

# SEWICKLEY CREEK WATERSHED AREA OF INTEREST

## REGION OVERVIEW

The Sewickley Creek Area of Interest is approximately 167 mi<sup>2</sup> and contains 508 miles of streams that drain southwest into the Youghiogheny (outlet indicated by a star on the map, left). Landcover in this watershed is predominantly deciduous forest and hay/pasture, with a concentration of urbanized land and associated impervious surface around the towns of Greensburg and New Stanton. Sub-watersheds were delineated ranging from 0.07 to 2.56 square miles in size. Most sub-watersheds were in the range of 1-2 square miles.

### Why is this watershed of particular interest?

During Phase I assessment, this watershed was identified as an area of interest due to recent, rapid growth and the potential for more and numerous recurrent flooding problems.

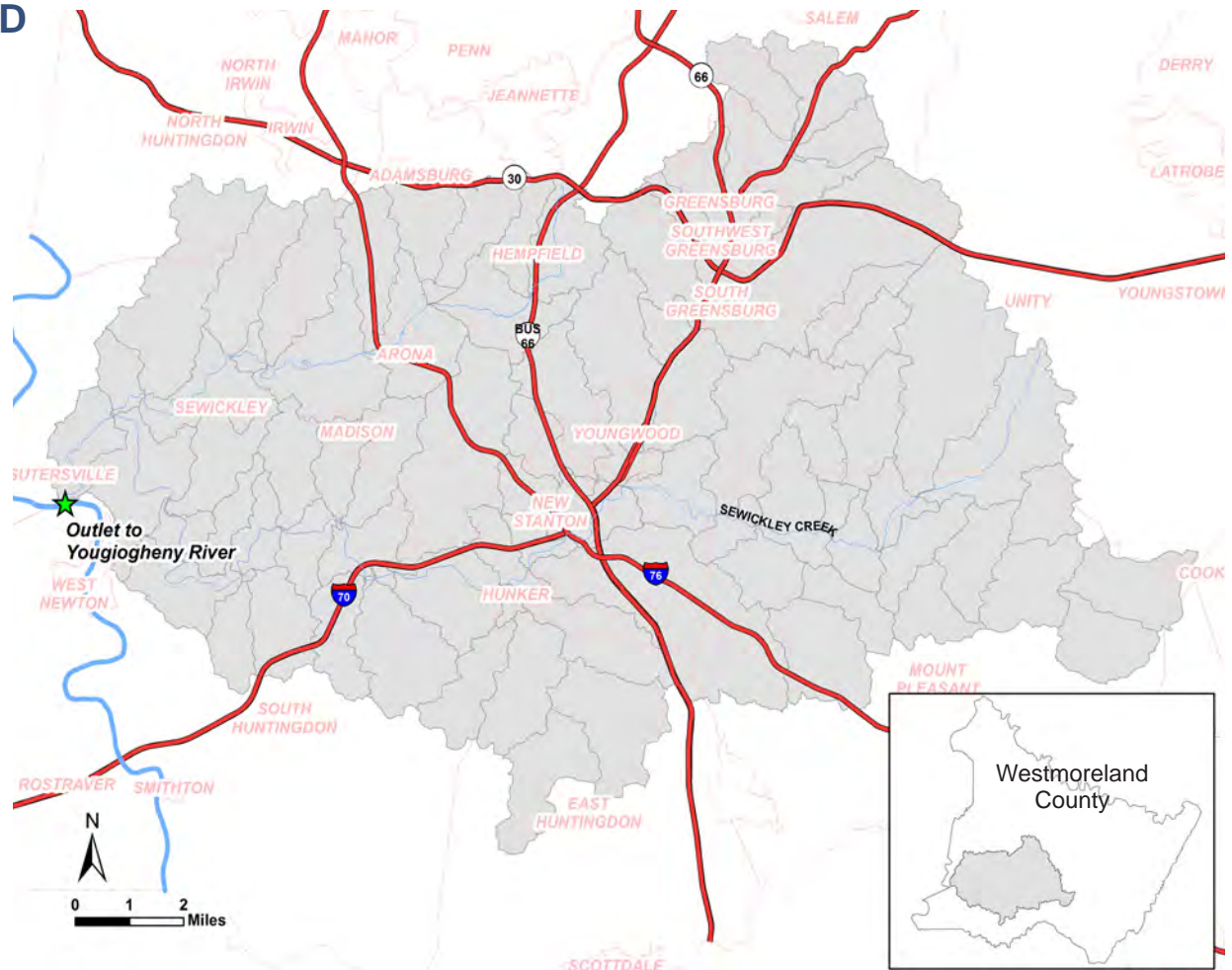

Source - Ethos Collaborative

**WATERSHED SNAPSHOT**

- **Area:** 167 square miles
- **Water Quality:** Impaired for Aquatic Life and Recreational Uses
- **Characterization:** This area of interest features heavily developed commercial corridors and the county seat City of Greensburg
- **Highways** provide relatively quick transportation from more rural outskirts to urbanized areas.

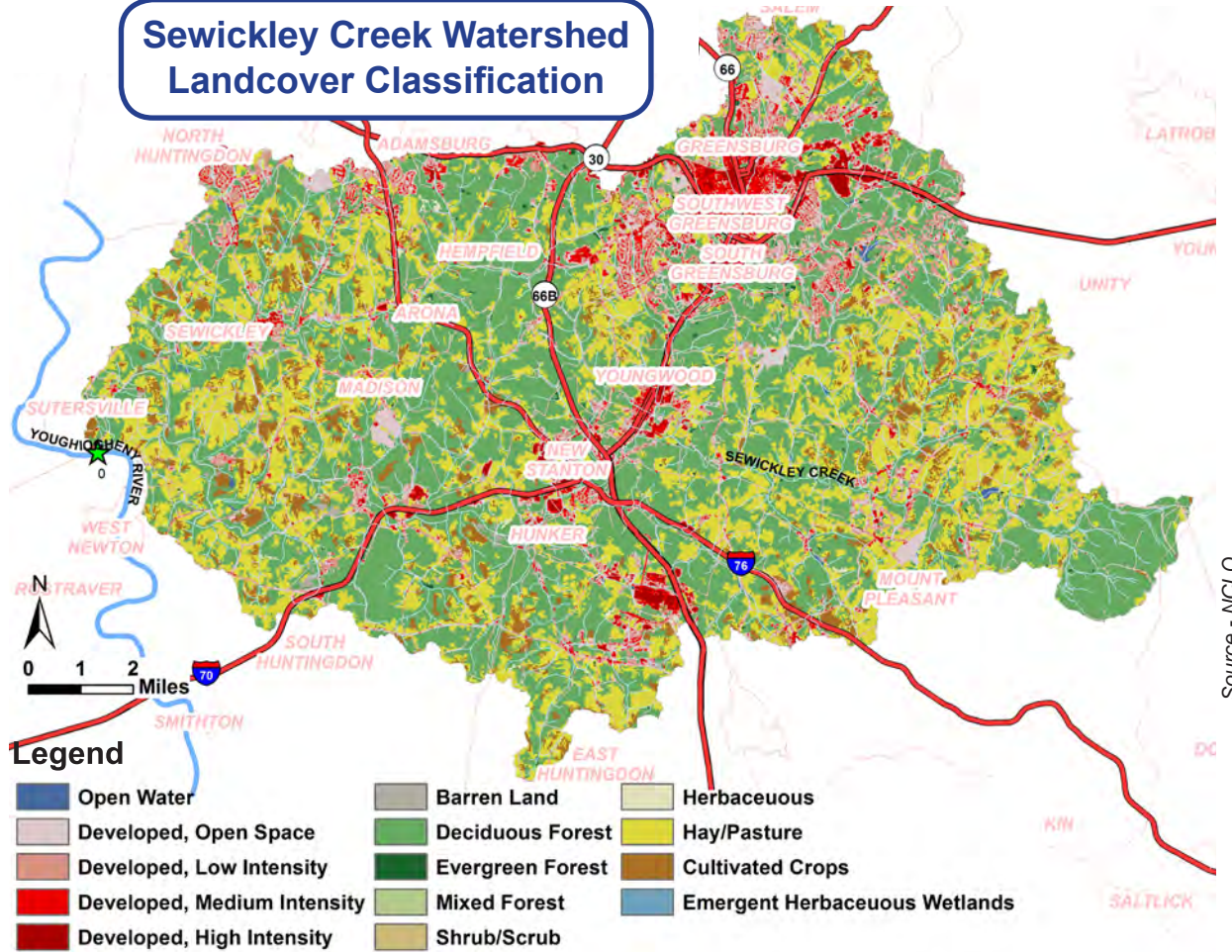

Photo by Tom Keller

Sewickley Creek Watershed Association volunteer tree planting at Jack's Run



## Sewickley Creek Watershed Landcover Classification



### Assets in the Watershed

Although some regions are undergoing rapid development, there is significant potential to guide this development in the future. The forested and farmed land uses still comprise over 76% of the watershed as a whole. The Sewickley Creek Watershed Association helps to guide and encourage sustainable development of this land.

### Landcover / Landuse

Landcover in this watershed includes a significant amount of urban growth, and the potential for more. There is a concentration of urbanized land and associated impervious surface around the Westmoreland County Seat, the city of Greensburg, the highway interchanges in Hempfield and New Stanton, and the regions along State Route 30. This region also has a significant amount of land that is used for hay/pasture and croplands. Landcover data is based on the 2011 National Land Cover Dataset created by the Multi-resolution Land Characteristics Consortium (MRLC). Refer to [www.mrlc.gov](http://www.mrlc.gov) for methodology.

Source - NCLC

Landcover Class	Acres	Total Area (%)
Open Water	172	0.2
Developed- Open Space	10150	9.5
Developed- Low Intensity	8775	8.2
Developed- Medium Intensity	4393	4.1
Developed- High Intensity	1520	1.4
Barren Land	416	0.4
Deciduous Forest	47570	44.4

Landcover Class	Acres	Total Area (%)
EverGreen Forest	267	0.2
Mixed Forest	106	0.1
Shrub/Scrub	7.5	0.007
Herbaceous	152	0.1
Hay/Pasture	28230	26.4
Cultivated Crops	5306	5

## CURRENT WATER QUALITY IN THE SEWICKLEY CREEK WATERSHED

### Non-point source pollution

In all, the Pennsylvania Department of Environmental Protection identified 229 stream miles as “attaining” their designated uses of supporting aquatic life, 127 stream miles as “non-attaining” for the designated uses aquatic life (106 stream miles) and recreation (21 stream miles). The remaining stream miles are unclassified. In a watershed of this size, there are numerous Identified impairments from agricultural land, Abandoned Mine Drainage, runoff and nutrients from residential/urban areas within the watershed, and wastewater. Below, the map classifies the streams based on major impairment. These are considered non-point sources, originating not from one identifiable point but instead from diffuse sources across the landscape.

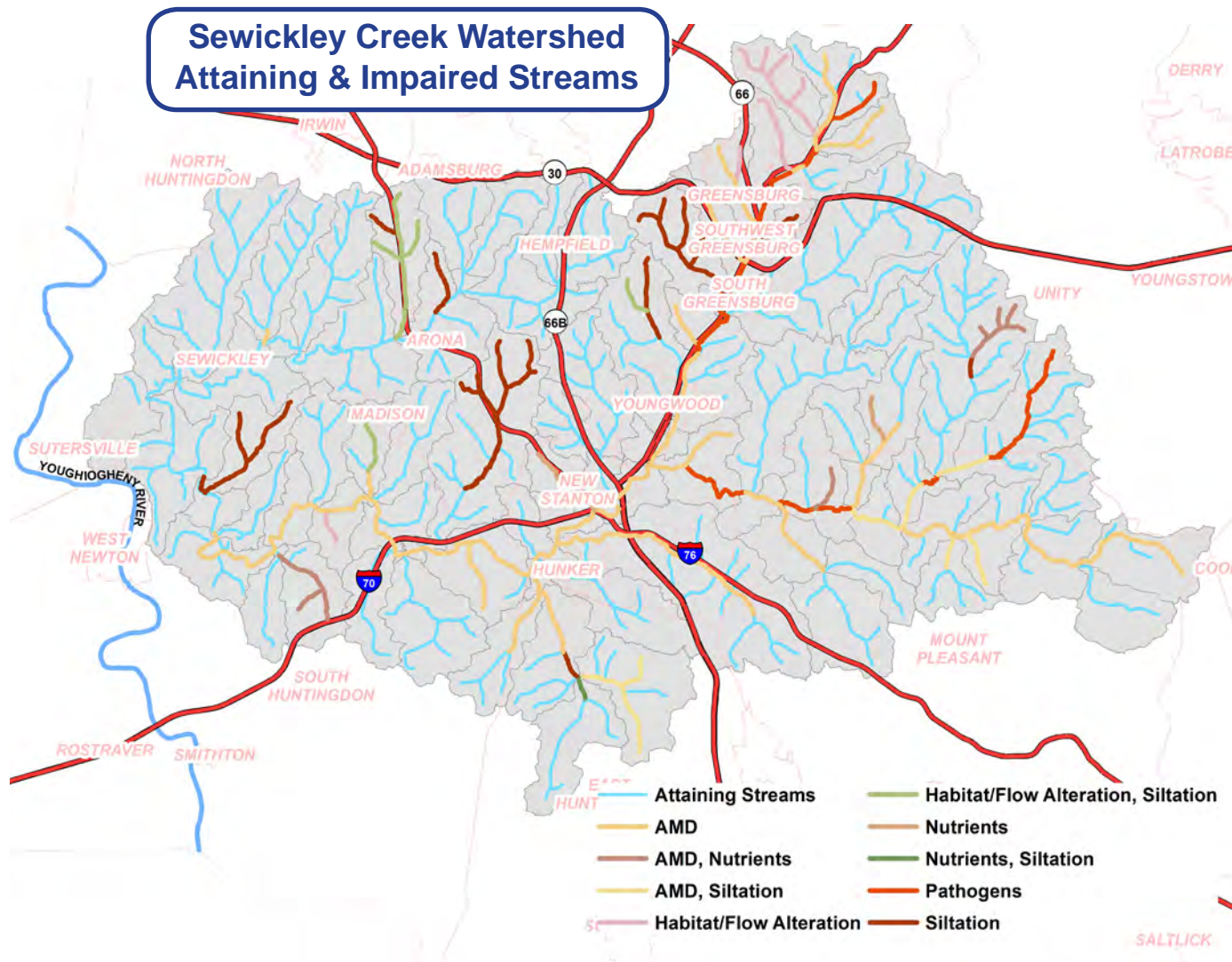

### TMDL status of the streams in this area of interest

All of the streams in the Sewickley Creek Area of Interest are under a TMDL, (Total Maximum Daily Load) agreement, The “Sewickley Creek Watershed TMDL.” This TMDL is a seeks to reduce pollution from Metals/ high pH (from Abandoned Mine Drainage) and Total Dissolved Solids. The other impairment sources are not addressed by TMDL agreements.

The Abandoned Mine Land Inventory identified 170 known sites in the Sewickley creek watershed, with a scant 30 of these classified as reclaimed. There are also 41 known Abandoned Mine Discharges. These discharges add sediment, change the pH of the water, and generally contribute to poor aquatic habitat conditions.



## WATER QUALITY AND WATER QUANTITY ARE INEXTRICABLY LINKED IN THE SEWICKLEY CREEK WATERSHED

As water accumulates and moves overland on impervious surfaces, it picks up pollutants from the surface of the landscape and delivers it to receiving waters. Development, particularly that which increases impervious surfaces on the landscape, increases the overland flow

of water during storms and decreases infiltration to groundwater. Increased stormwater also increases the erosive force of overland flow, increasing sediment load and delivering it to downstream receiving waters. As stormwater runoff increases, so does the water's capacity to carry sediment and nutrients such as Nitrogen and Phosphorus. These contributed to downstream pollution problems. In the end, water from this region reaches the Gulf of Mexico, where nutrients and pollution collect and create an area of poor habitat quality.

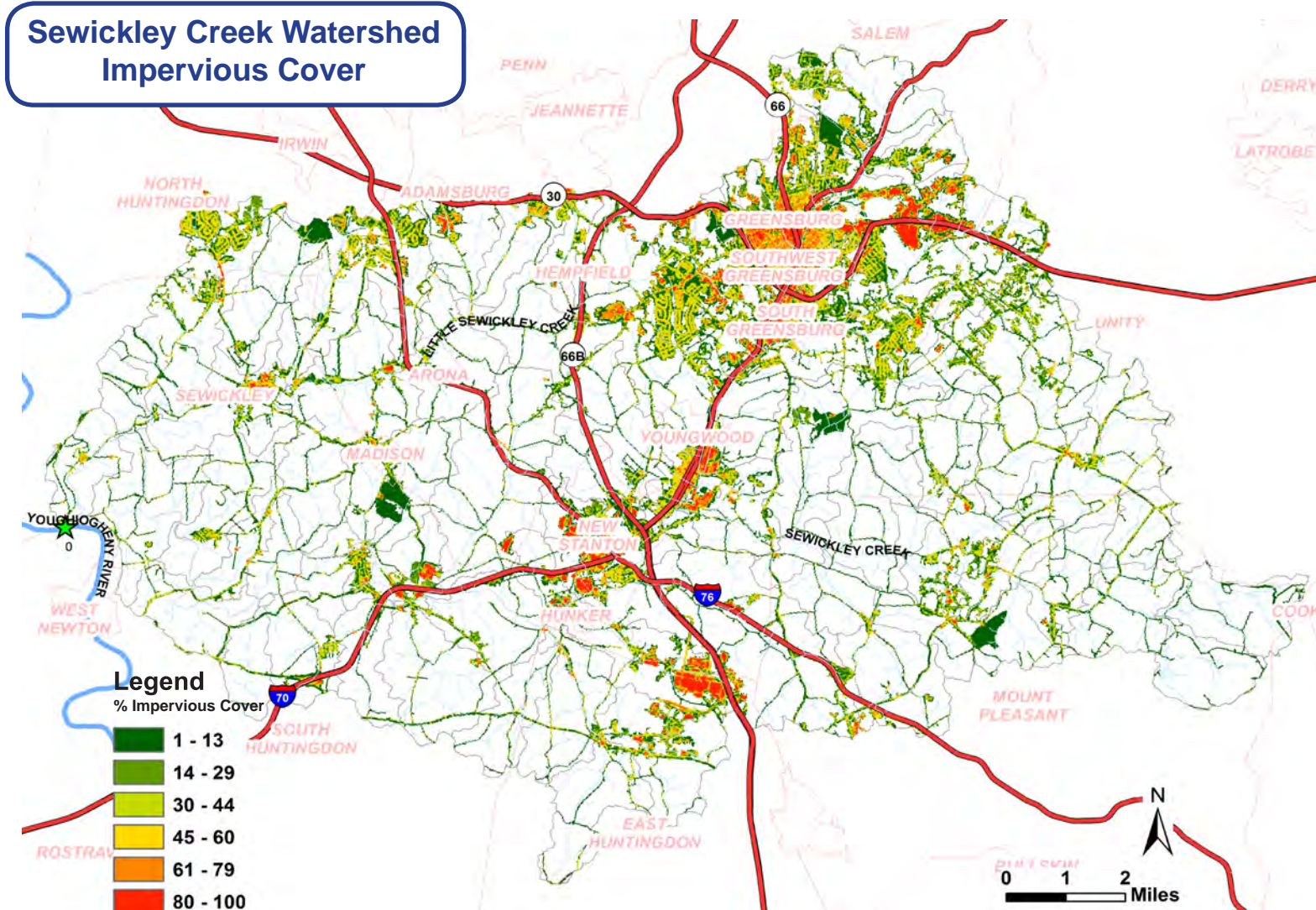

Source - NLCD



## FUTURE TRENDS IN THE SEWICKLEY CREEK WATERSHED

This watershed will likely see increasing development and a reduction in forested and agricultural land. These land-use trends will likely add to stormwater runoff and non-point pollution loadings. There is tremendous opportunity to carefully plan now in order to

mitigate the potential increase in flooding and pollution delivery downstream. The projections below are compiled from the ESRI GREEN INFRASTRUCTURE Online Mapping tool, developed in conjunction with the Clark Labs (<http://www.esri.com/about-esri/greeninfrastructure>).

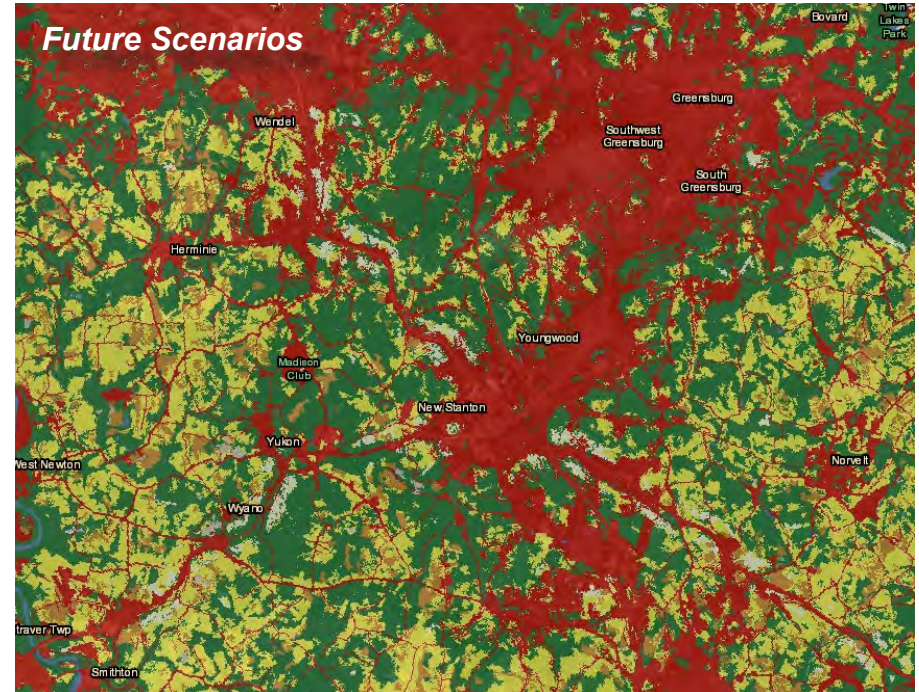
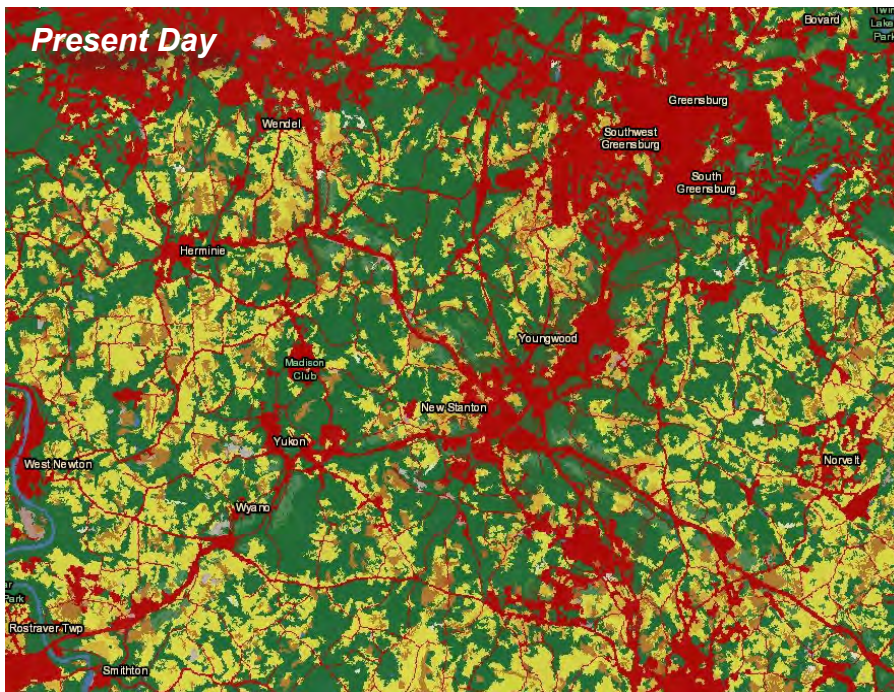

Source - ESRI

### Legend

#### National Land Cover Database

 Open Water	 Grassland/Herbaceous
 Perennial Ice/Snow	 Pasture/Hay
 Developed	 Cultivated Crops
 Barren Land (Rock/Sand/Clay)	 Herbaceous and Woody Wetlands
 Forests	
 Scrub/Shrub	

### Specific predictions of change in land-use

Above, a visual comparison of land use in 2011 versus predicted land use in 2050 highlights the forecasted increase in impervious surfaces. This analysis of land use change in the Sewickley Creek Area of Interest specifically estimates

- A 21% *INCREASE* in developed land,
- A 11% *DECREASE* in forest cover
- A 9% *DECREASE* in agricultural cropland



## HYDROLOGIC WATERSHED MODELING:

### INPUT PARAMETERS AND MODEL CALABRATION & FINAL RELEASE RATES FOR THE SEWICKLEY CREEK WATERSHED

Controlling water now and in the future requires an understanding of current conditions and pollution sources. The *Parameters* below and on the following pages were used in hydrological models to help us understand the contribution of different sub-watersheds to the flow of the whole, and possible future changes.

**Hydrologic Soil Groups in the Sewickley Creek Watershed.** The map below is color-coded by the Hydrologic Soil Group, which indicates a soil's water holding capacity. Group A soils have low runoff potential and high infiltration rates, while Group D soils show the highest runoff potential with very low infiltration rates. Also shown are the specific soil names, please see appendix for a list and descriptions of individual soil types.

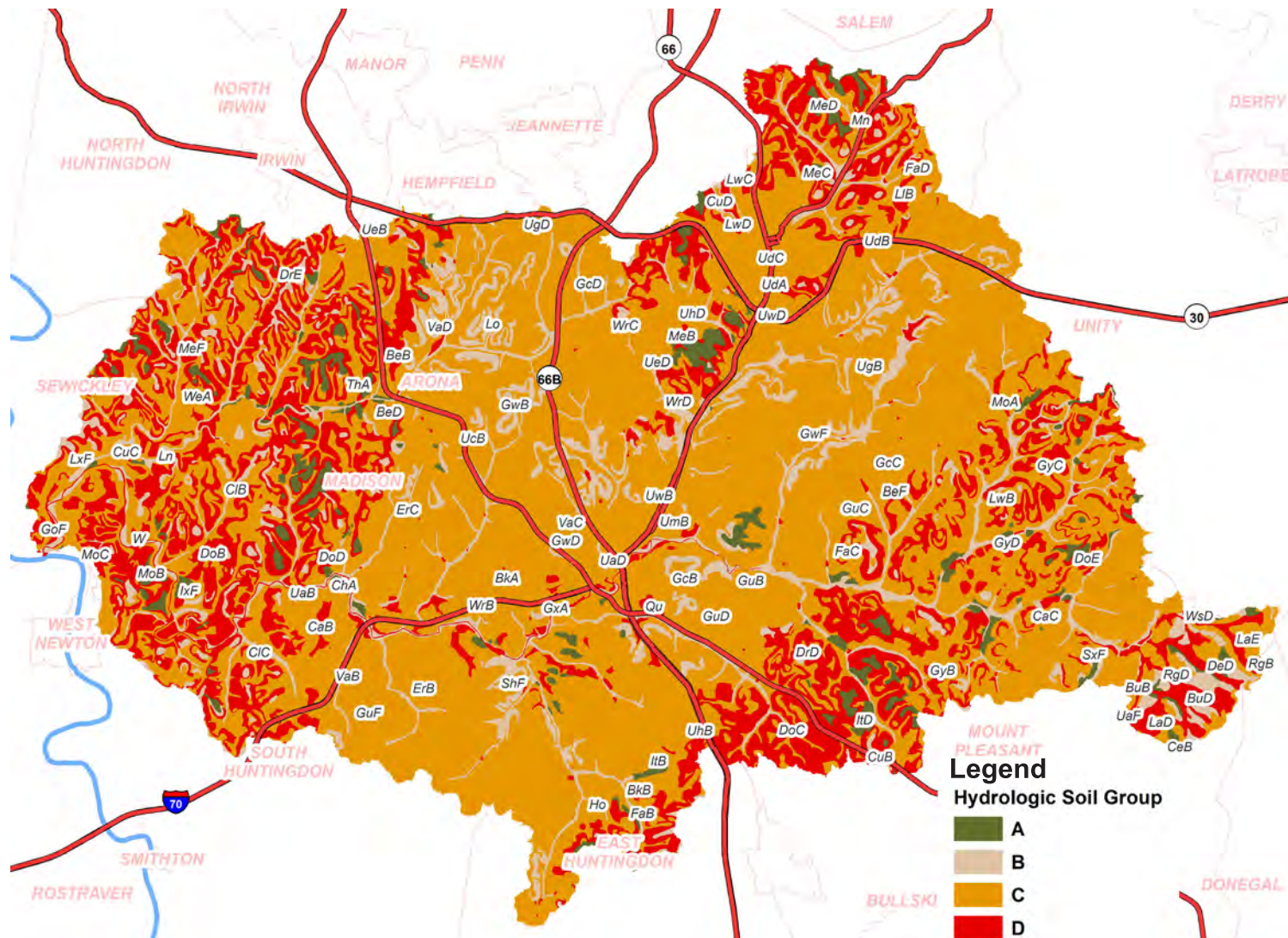

Source - PASDA

**Basin Curve Numbers (“CN’s”) in the Sewickley Creek Watershed** are an empirical parameter that help predict direct runoff/infiltration from a parcel of land during a rain event. In the Kiskiminetas are of interest, these range from 65 to 78. Watersheds with a higher curve number indicate higher runoff potential, leading to greater flooding and pollution delivery to streams.

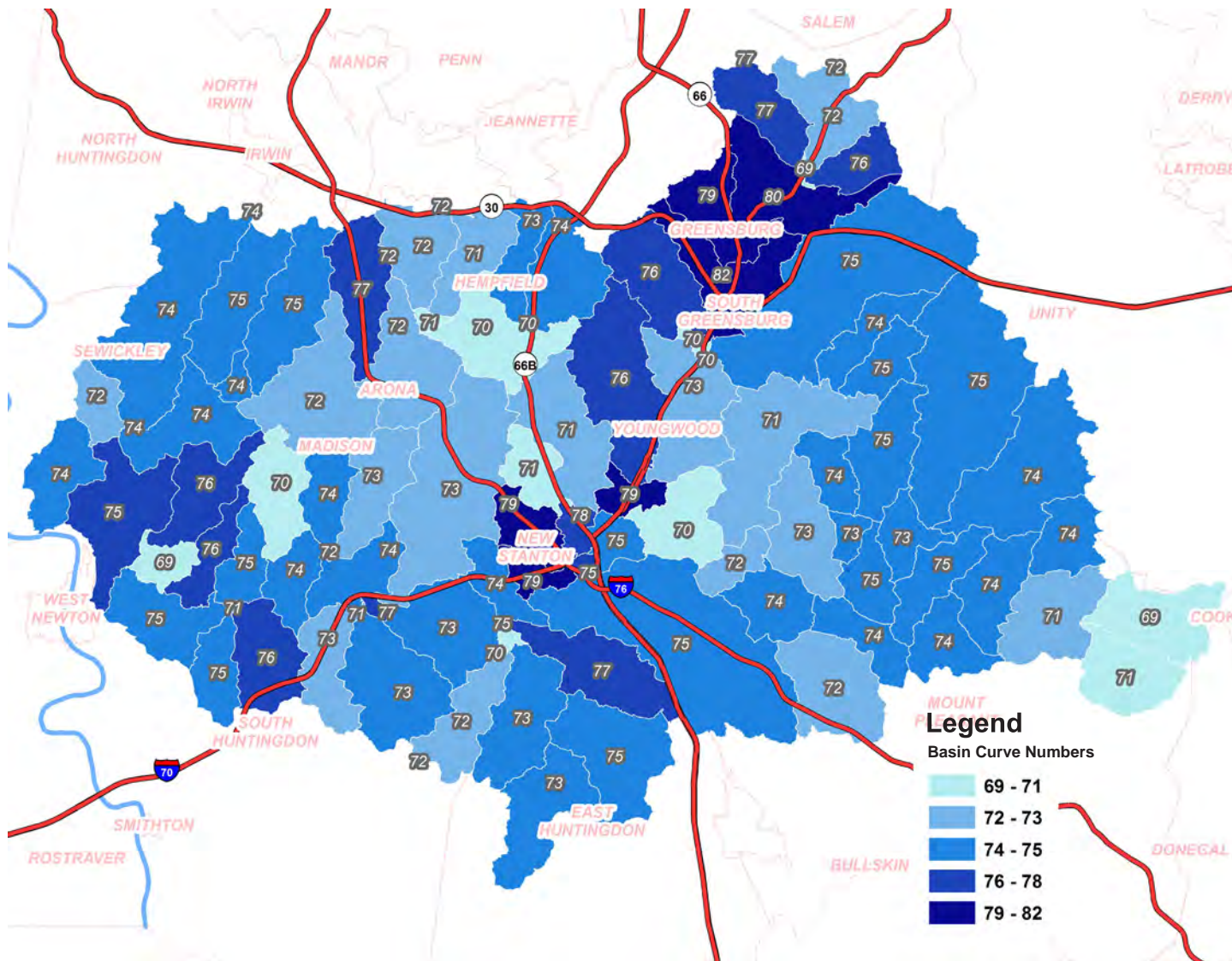

Source - Ethos Collaborative



**Average Basin Slope (%) in the Sewickley Creek Watershed.** Generally most regions in this watershed show a moderate slope, with a basin-wide average slope of 14%. Steeper slopes are found in the stream valleys and shallower slopes on the upland regions. Slope steepness contributes to overall runoff calculations and the calculation of basin release rates, as steeper regions generally experience greater runoff during rain events.

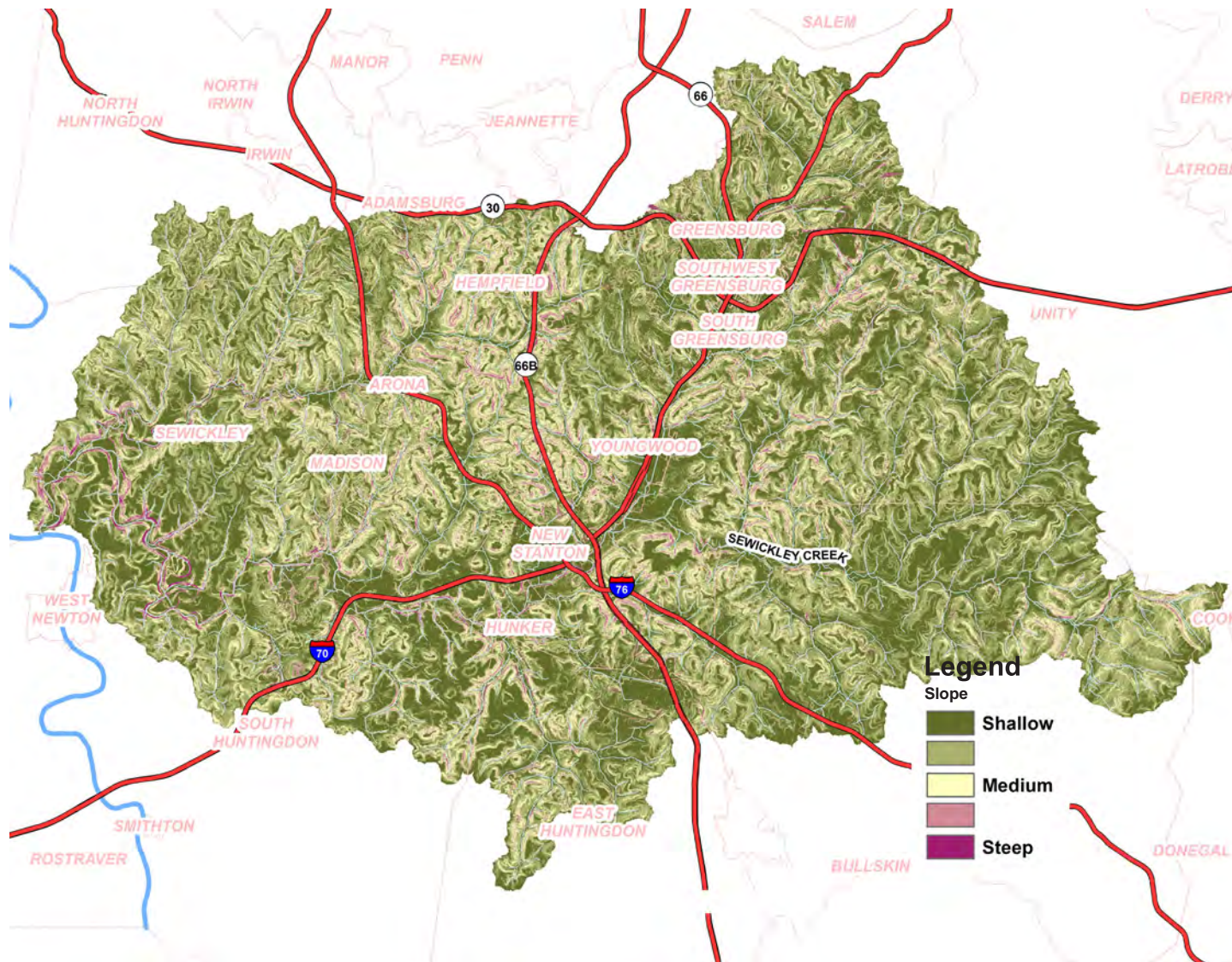

Source - Ethos Collaborative



**The Basin Storage Ratio in the Sewickley Creek Watershed** indicates the proportion of each sub-watershed that can store water in a storm, instead of directly increasing stream discharge. Storage areas include lakes, ponds and floodplains. Storage ratios range from 0.0008 to 0.1999, therefore the storage amount available in each sub-watershed varies from 0.08-20% of the sub-watershed area.

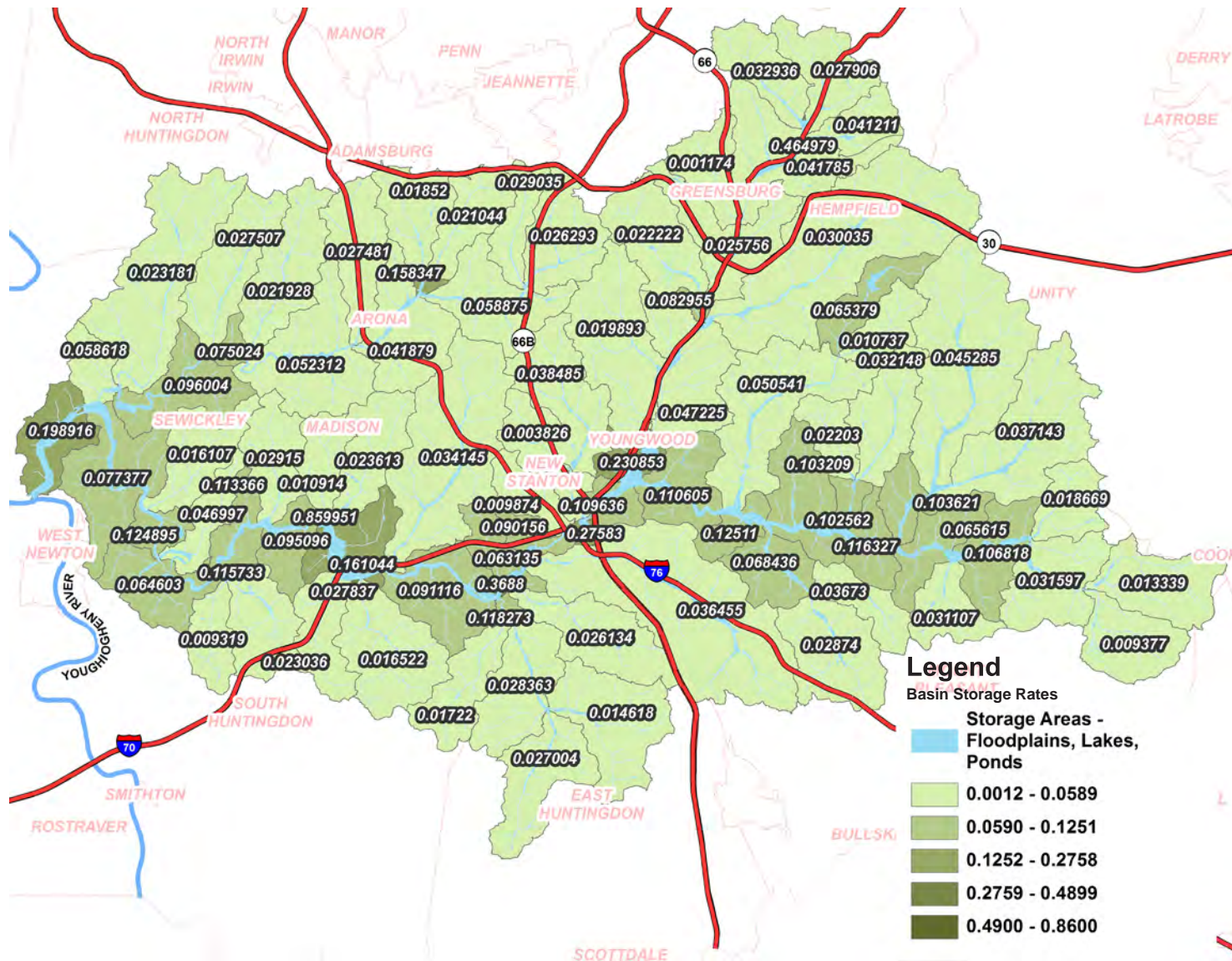

Source - Ethos Collaborative

Sewickley Creek Watershed - 109



## MODEL CALIBRATION IN THE SEWICKLEY CREEK WATERSHED

The Westmoreland Conservation District installed two water level gauges in this watershed, shown below, along Sewickley Creek and Jacks Run. These gauges provided important calibration data for this watershed, to compare modeled results to real-world discharge data. In addition, 10 sites were chosen and model results were

compared to StreamStats for the same sites. This approach allowed for the fine calibration of hydrological models, in the absence of multiple stream gage locations in the watershed. Calibration sites were placed at important stream junctions throughout the watershed. Individual sites are designated with “J” below. For the methodology used for calibration, validating statistics and comparisons refer to the methodology in the appendix.

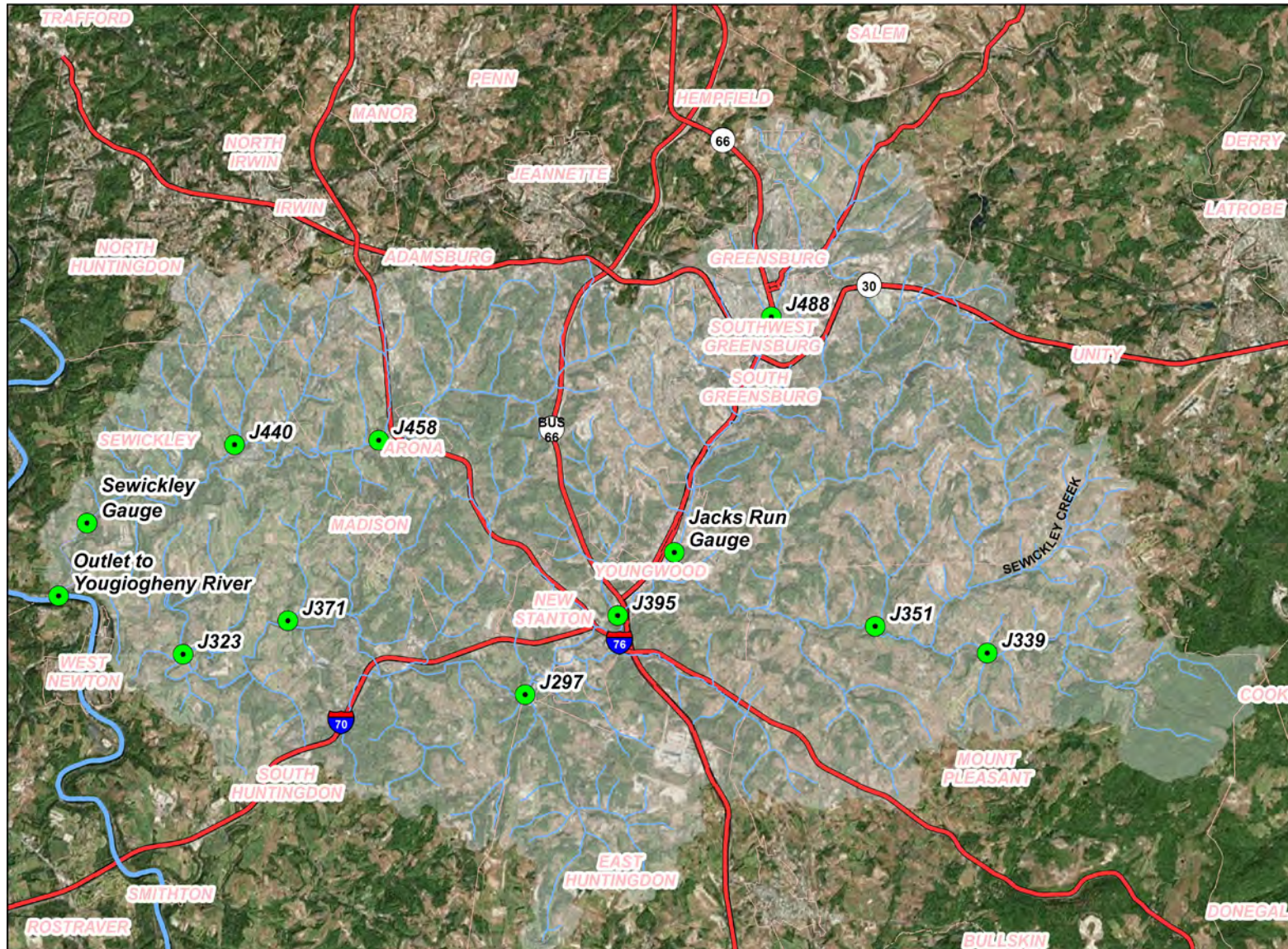

Source - Ethos Collaborative



## RECOMMENDED RELEASE RATE MAP FOR THE SEWICKLEY CREEK WATERSHED AREA OF INTEREST

Release rates are a tool that help determine the timing of when water can be released from a watershed. A release rate of 50% for a sub-watershed indicates that the rate at which stormwater moves out of the watershed and downstream must be reduced by half in any future development. In contrast, a release rate of 100% indicates that, with future development, stormwater can move off of the sub-watershed at the same rate that is does in the present. In other words, lower release rates require an increased control of runoff.

Release rates were calculated based on a hydrologic model of the area of interest using HEC-HMS, the U.S. Army Corps of Engineers (USACE) Hydrologic Modeling System, in conjunction with GEO-HMS (a GIS extension that allows for the manipulation of spatial data).

Final calculated release rates show a range in value from 50-100%. Darker colors and lower release rates indicate regions where future development must reduce runoff rates.

It should be noted that the methodology to calculate release rates focuses on the basin-wide contribution of upstream land on downstream flooding. In order to control more localized flooding, individual municipalities may enact stricter stormwater runoff controls.

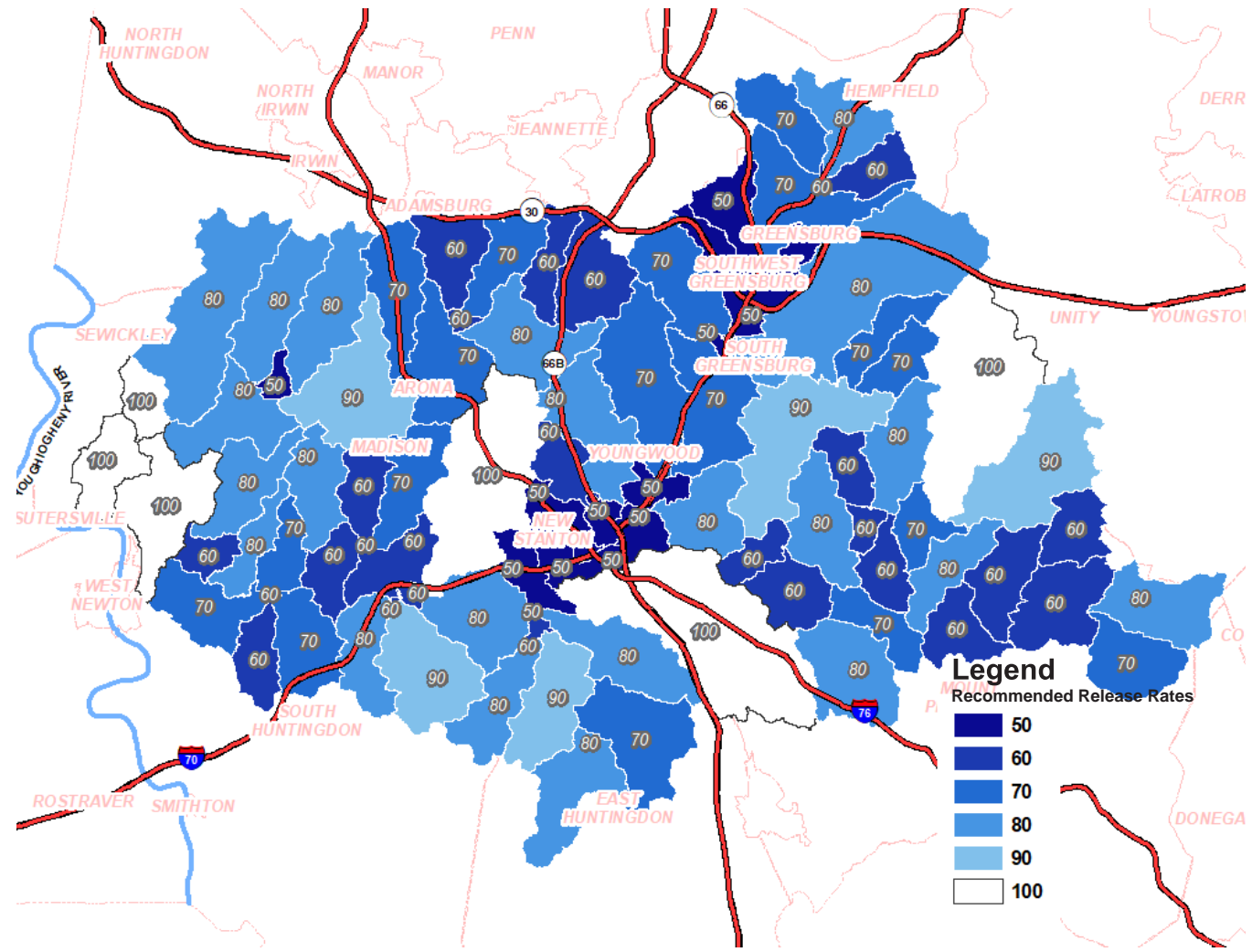

Source - Ethos Collaborative



## LANDSCAPE POLLUTION ACCUMULATION MODELING

To understand where and how pollution-bearing runoff moves across the landscape, we modeled accumulation using ArcGIS in conjunction with a specialized terrain analysis toolset, (TAUDEM). This analysis allowed us to understand both pollution contributions and pollution reductions due to the underlying landscape. Please see the Methodology Appendix for further details about this process.

### TOTAL SUSPENDED SOLIDS (TSS)

Sediment, or Suspended Solids, encompasses any number of particulate pollutants or natural particles, from a myriad number of sources. Shown to the right is the estimated sub-watershed export of sediment, in pounds per year. It should be noted that this analysis does not include the sediment resulting from point source discharges, such as abandoned mine drainage, or in-stream sedimentation.

- The high percent of impervious surfaces in the urbanized centers of Greensburg and New Stanton collect solids during dry weather and then during wet weather contribute to high TSS loads. These sub-watersheds have little in the way of riparian buffers or other landscape features that help to slow, infiltrate, and absorb water.
- Significant contributions of TSS are also found in sub-watersheds where agricultural activities such as grazing and plowing take place. These regions in particular would benefit from the increase in riparian buffers as a way to capture water and associated pollutants before it reaches the stream.

### Sewickley Creek Watershed Annual Sediment Loading (lbs per acre per year)

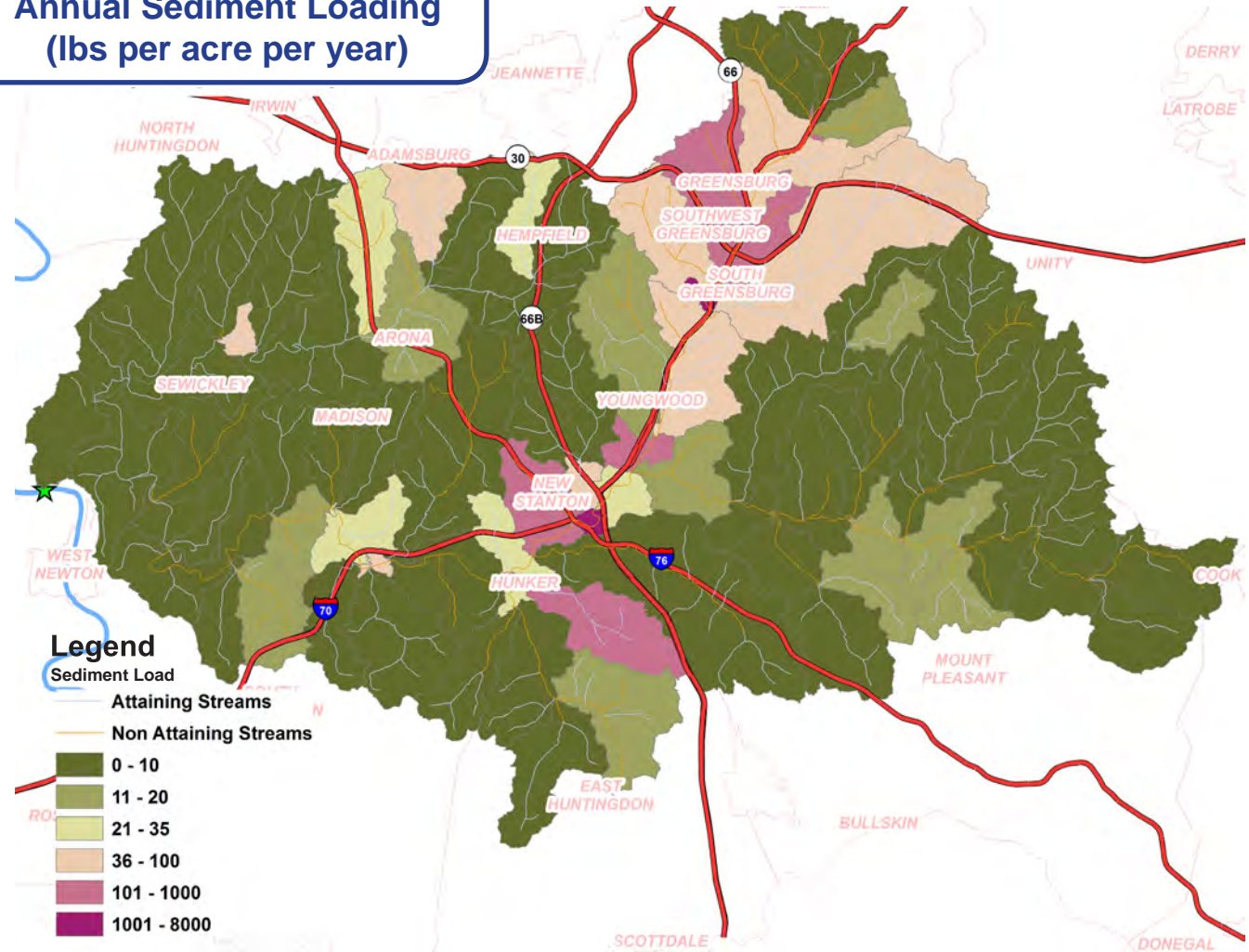

Source - Ethos Collaborative

## NITRATE (TNO<sub>3</sub><sup>-</sup>)

Nitrogen, here expressed as nitrate (NO<sub>3</sub><sup>-</sup>), is a nutrient essential for plant and animal growth. Historically, biologically available nitrogen was a limiting factor in ecosystems, however industrial activities have increased biologically available nitrogen to the point where it is now considered a pollutant in many regions. Below, the sub-watershed export of nitrate is expressed in pounds per year.

- Agricultural activities and residential areas both contribute fertilizer-sourced nitrogen to the watershed. Fertilizer applied to croplands and residential lawns can be washed from the land surface into streams.
- Nitrogen can be found in urine excreted from grazing animals. Urine-sourced nitrogen is biologically transformed to nitrate, which can then be transported downstream.
- Fixed nitrogen is emitted to the atmosphere when fossil fuels are burned. This nitrogen is deposited as nitrogen oxides or NO<sub>x</sub>, on the landscape, with concentrations found in near-road areas.
- Wastewater contains biologically available nitrogen. Wastewater treatment plants may not remove all of the nitrogen before treated water is discharged to streams. Septic systems also contribute biologically available nitrogen to groundwater.

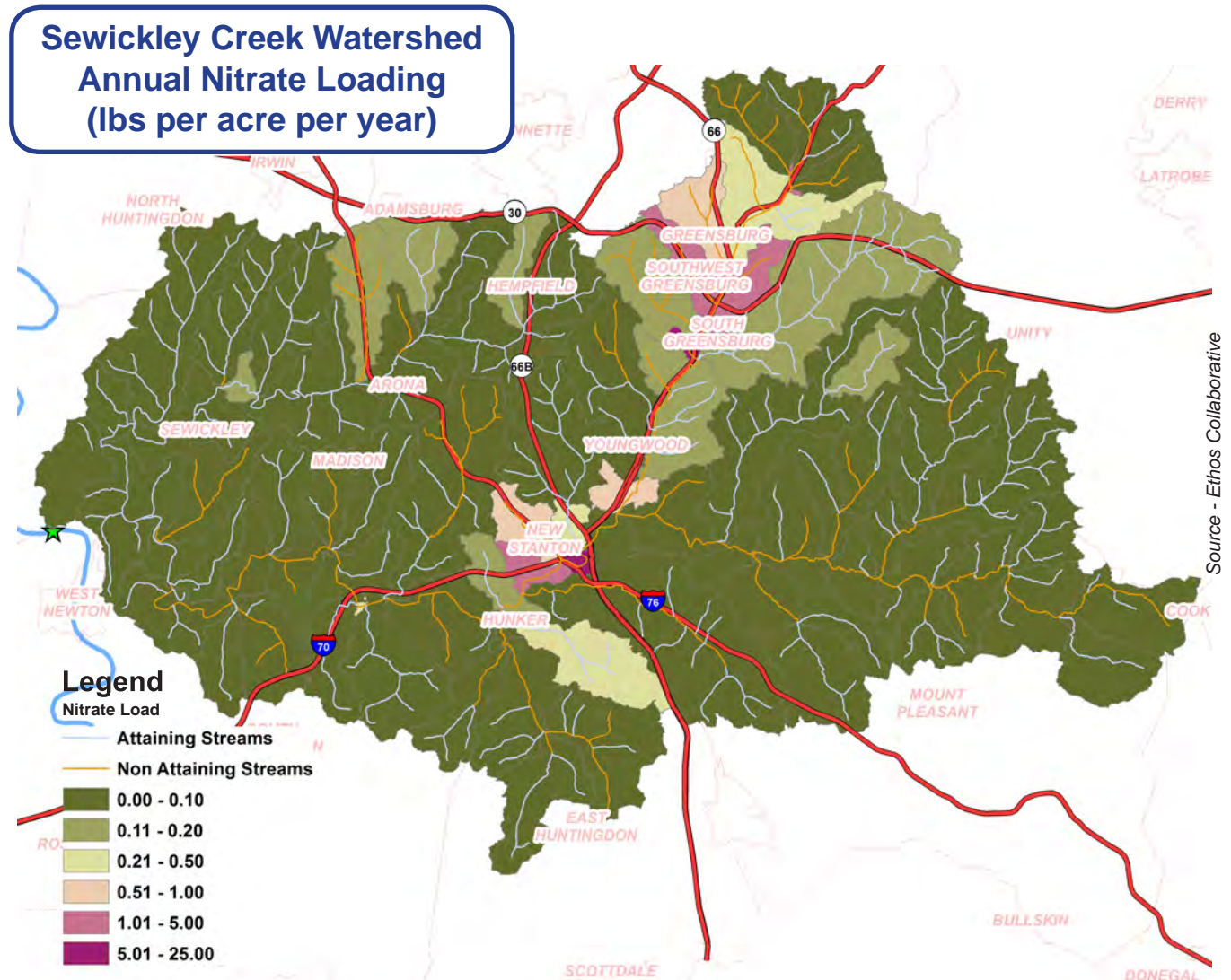



## TOTAL PHOSPHORUS (TP)

Phosphorus, here expressed as Total Phosphorus (TP) is a nutrient essential for life. Phosphorus, like Nitrogen, used to be a limiting nutrient for ecosystems. Industrial activities and fertilizer both contribute excess phosphorus to ecosystems. This phosphorus contributes to algae blooms in water bodies, eutrophication, and overall habitat deterioration. Shown on the map to the right is the modeled sub-watershed export of TP in pounds per year.

- Higher amounts of phosphorus are exported from the urban sub-watersheds such as Greensburg and New Stanton. Phosphorus is sourced primarily from lawn fertilizer and roadway deposition. These sources produce both particulate and dissolved forms of phosphorus.
- Soil erosion is another contributor of phosphorus to streamwater. Erosion depletes the soil of valuable nutrients like phosphorus and transports the nutrient downstream, where it can contribute to water body eutrophication.
- Crops lands export Phosphorus to downstream environs, sourced from fertilizer applied to the fields. Fertilizer-sourced Phosphorus is likely in particulate forms, and therefore structural BMP's that filter and/or detain sediment and particles can help to mitigate downstream export.
- Wastewater contains phosphorus from human waste and detergents. Wastewater treatment plants may not remove all of the phosphorus before treated water is discharged to streams.

### Sewickley Creek Watershed Annual Phosphorus Loading (lbs per acre per year)

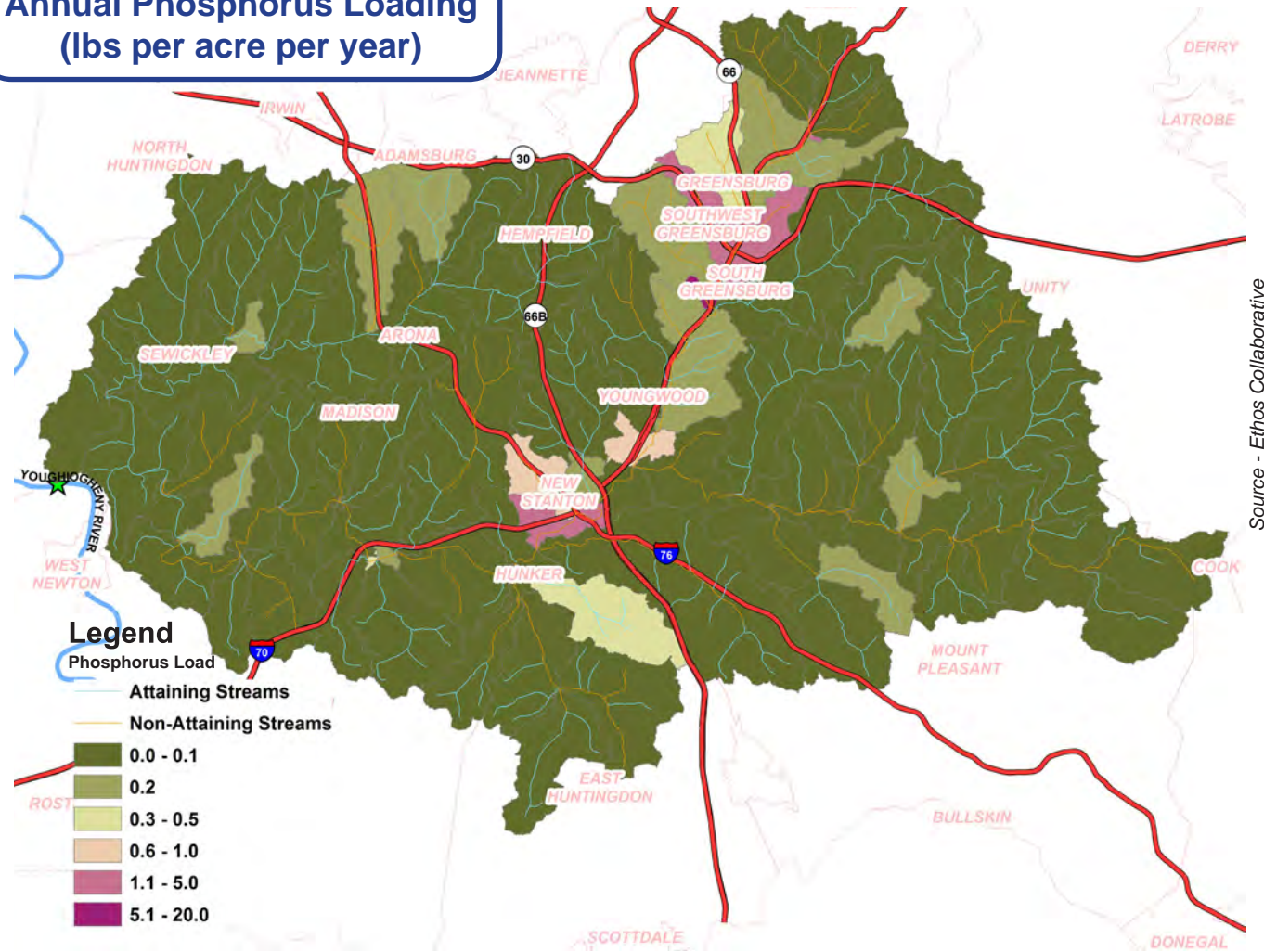

## OPPORTUNITIES FOR EFFECTIVE STORMWATER MANAGEMENT:

Based on Modeling Watershed Hydrology and Pollution Sources to Inform Smart Water Management

### Effective water management protects valuable resources and built infrastructure.

The drinking water and agricultural soils in this watershed are both valuable resources that must be conserved for future generations. Conservation efforts should consider ways to manage water runoff that decrease soil erosion, pollution transport, and in-stream erosion. The Sewickley Creek watershed is also affected by Abandoned Mine Drainage, which contributes to in-stream sedimentation, decreased habitat quality, and streamwater affected by acidic or alkaline mine drainage waters.

### To increase water quality, we must decrease overland flow and water quantity.

Water detained by increasing infiltration to groundwater encourages nutrient retention, or the uptake and filtration of pollutants by biota and soil. Together, the processes of detention and retention increase water quality through decreasing erosion and downstream transport.

### Conceptual ideas for BMP's/ Landscape Restoration: Highlighting the potential for water and pollutant capture and retention.

Identified issues include stormwater runoff and associated erosion, as well as the identification of sites appropriate for Green Infrastructure such as stormwater retrofits, riparian buffer restoration, and stream restoration. When coupled with the landscape-based nutrient accumulation and decay modeling, this list can help to identify and prioritize projects for future conservation efforts.

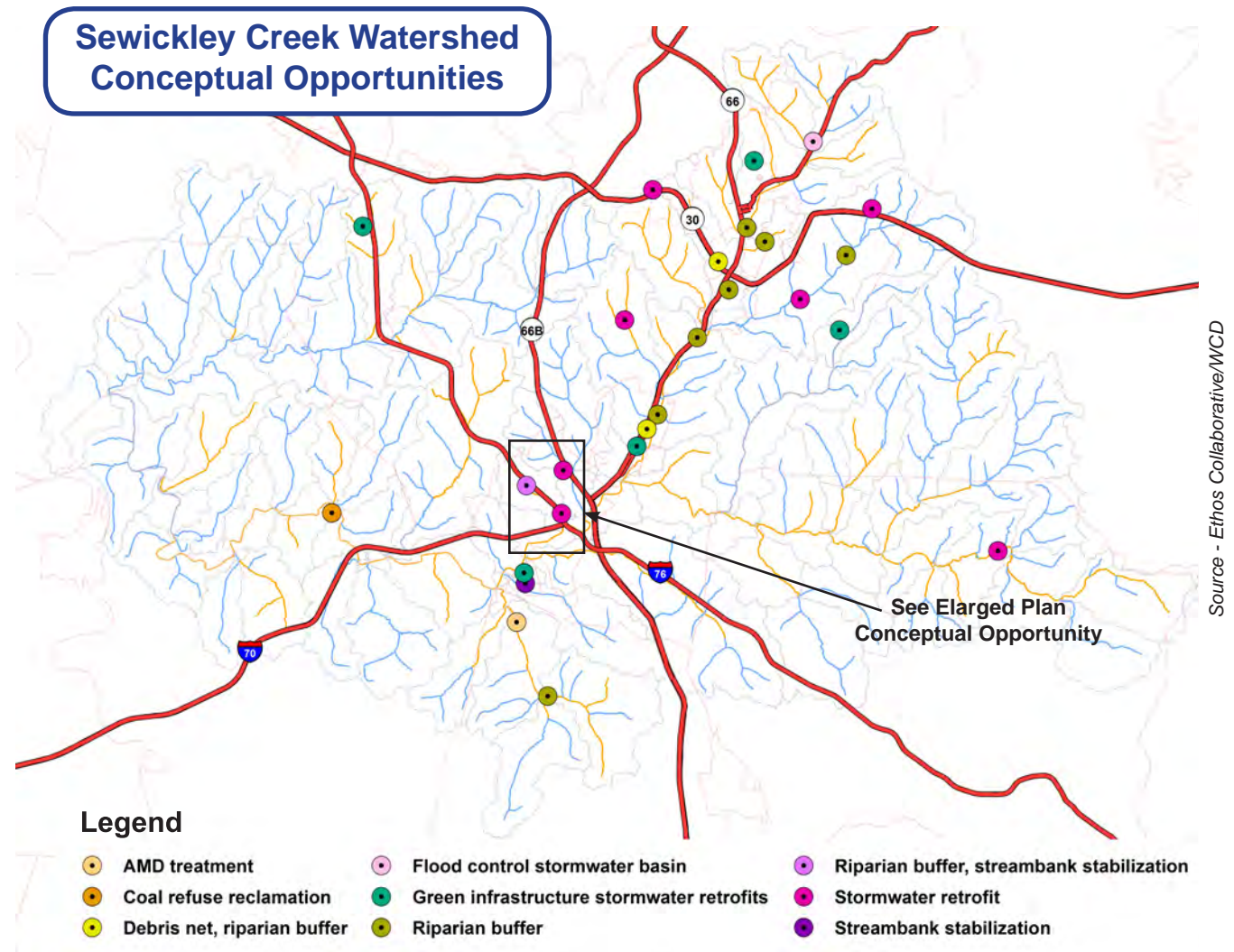



## CONCEPTUAL OPPORTUNITY IN THE SEWICKLEY CREEK WATERSHED: WATERSHED IMPLEMENTATION PLAN

This small watershed (719 acres) is drained by ~2 miles of stream, yet estimates indicate it may contribute up to 241 pounds per acre every year of sediment to Sewickley Creek. The landuses are primarily developed (417 acres) and farmland (142 acres). During rain events, water flows across the farm fields and parking lots, contributing to increased downstream flooding, sediment, and nutrient loads. The watershed contains several large industrial complexes and associated parking lots. Significant watershed improvement could be gained by routing parking lot runoff through basins retrofitted to capture stormwater and settle sediment. Bioswales, bioretention, and enhanced riparian buffers would help infiltrate runoff and capture pollutants.

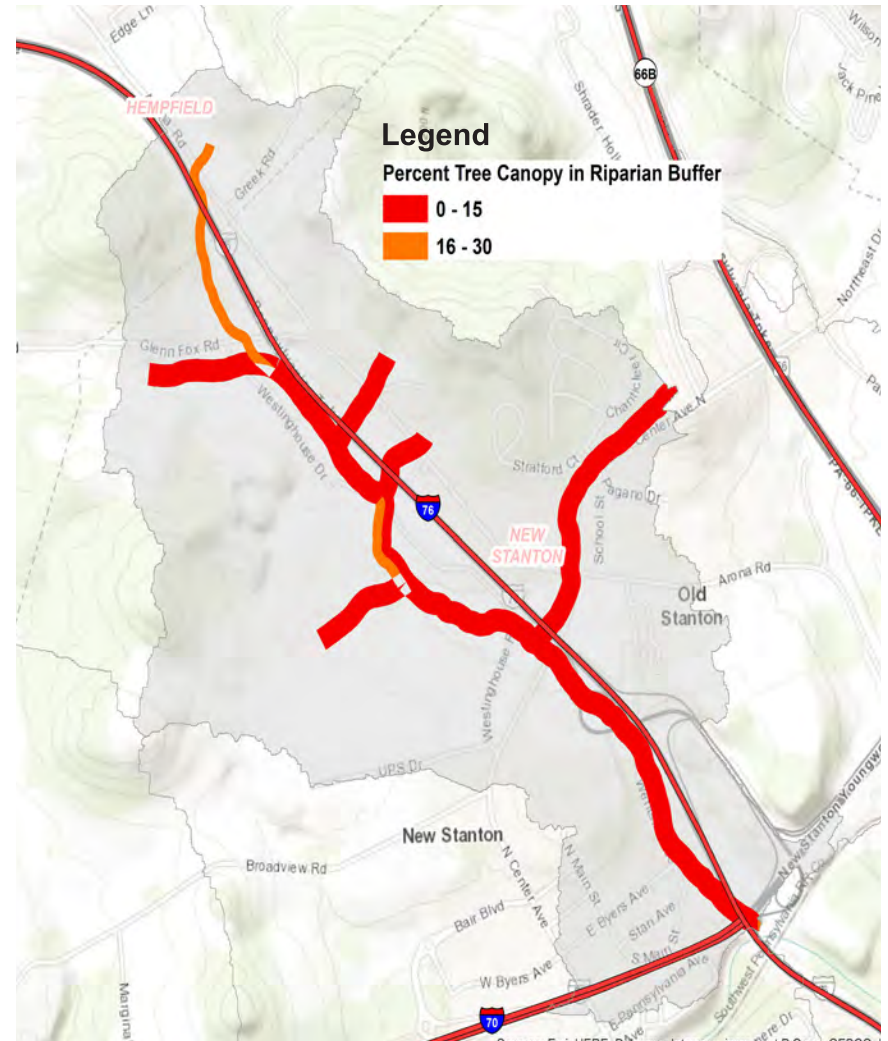
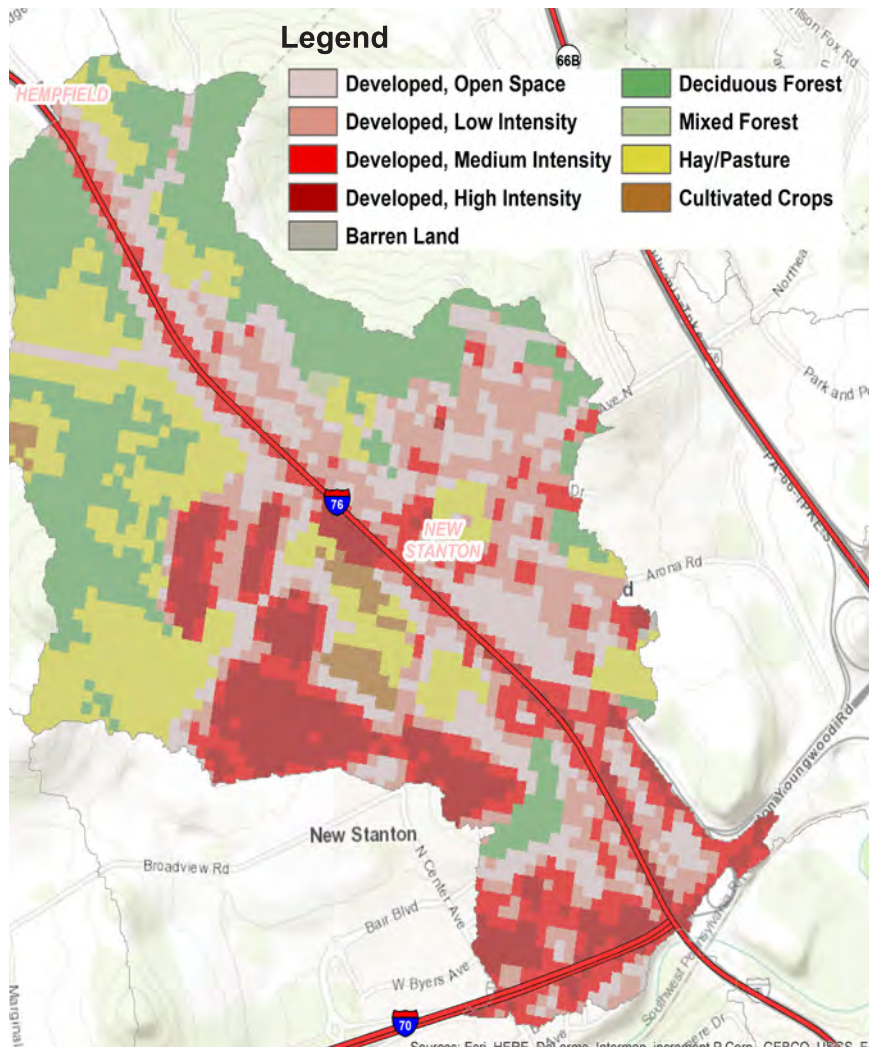

Source - Ethos Collaborative

Source - NLCO

Enlarged Plan: The lack of a healthy riparian buffer along the stream in New Stanton contributes to stream impairment but provides opportunities for establishing water quality BMPs.

Enlarged Plan: High stream flows and polluted runoff are the result of high density development in this New Stanton Watershed.

# KISKIMINETAS WATERSHED AREA OF INTEREST

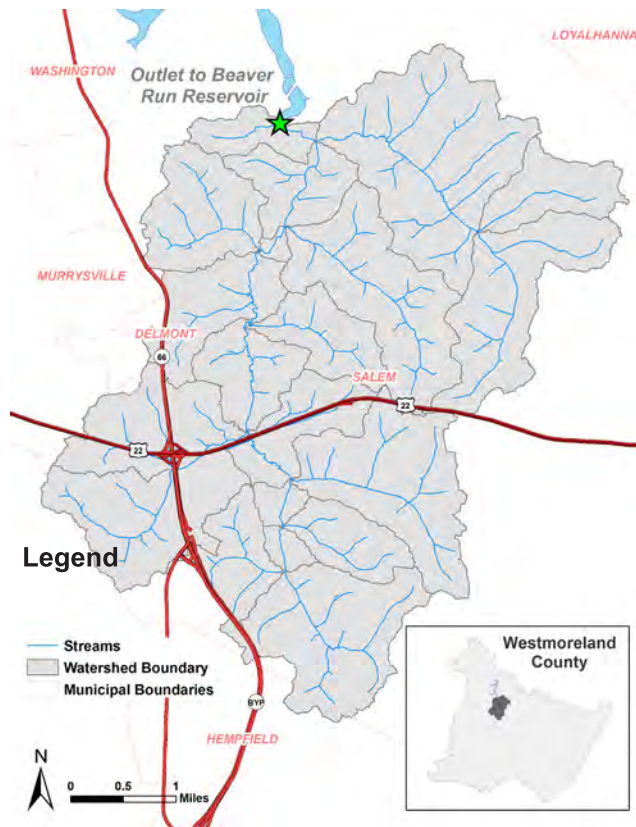

Source - Ethos Collaborative

## REGION OVERVIEW

The Kiskiminetas Area of Interest is approximately 19 mi<sup>2</sup>/12,193 acres and contains 56 miles of streams that drain north into the Beaver Run Reservoir (outlet indicated by a star on the map, left). Landcover in this watershed is predominantly deciduous forest and hay/pasture, with a concentration of urbanized land and associated impervious surface around the town of Delmont and the State Highway 66/Old William Penn Highway (Rte 22) interchange. Twenty-one sub-watersheds were delineated ranging from 0.07 to 2.56 square miles in size. Most sub-watersheds were in the range of 1-2 square miles.

### Why is this watershed of particular interest?

This watershed was identified in Phase I as a region with recurrent flooding problems. This small watershed has great potential for rapid development, which would only exacerbate flooding problems. The region is located East of the city of Pittsburgh and the developing Monroville/Murrysville suburban complex. The largely rural landscape leaves room for future expansion of residential or industrial areas. The lovely landscape and outdoor amenities draw visitors and residents alike. There is tremendous opportunity to carefully manage future development and stormwater planning in this area.

### Assets in the Watershed

Water quality is of paramount importance in this watershed because the Beaver Run Reservoir serves as a drinking water supply to approximately 130,000 people. Ongoing collaborations between the Municipal Authority of Westmoreland County and researchers from Indiana University of Pennsylvania monitor the water and air quality at various locations in the Beaver Run Reservoir Watershed and around the reservoir. Sampling efforts are focused on areas with active Marcelles and Utica shale gas well pads, but are also examining the effects of other pollution, such as agricultural and urban runoff. Links to the project data and further information can be found at <http://www.iup.edu/energy/research-initiatives/beaver-run-reservoir/>.

### WATERSHED SNAPSHOT

- **Area:** 19 square miles
- **Water Quality:** Impaired for aquatic life
- **Characterization:** This area of interest is largely forested, with pockets of developed land.
- **Highways provide relatively quick transportation from this rural region to the cities of Pittsburgh and Greensburg.**
- **These qualities make the region an ideal location for future development.**



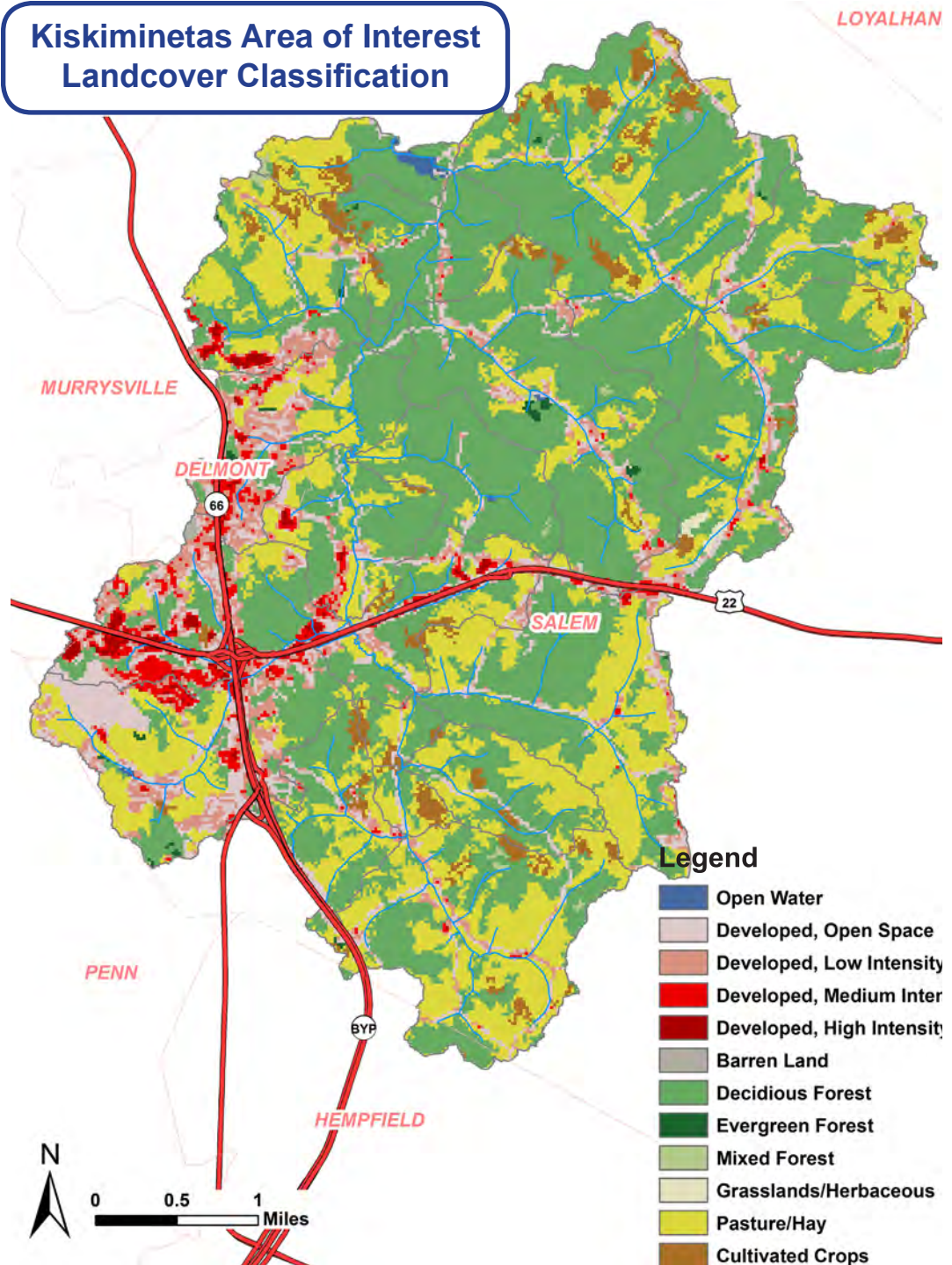

Photo - pawatersheds.org

Kiskiminetas River

## Kiskiminetas Area of Interest Landcover Classification

**Landcover / Landuse** Landcover in this watershed is predominantly deciduous forest and hay/pasture, with a concentration of urbanized land and associated impervious surface around the town of Delmont and the State Highway 66/William Penn Highway (Rte 22) interchange. Landcover data is based on the 2011 National Land Cover Dataset, created by the Multi-Resolution Land Characteristics Consortium (MRLC). Refer to [www.mrlc.gov](http://www.mrlc.gov) for methodology.



Source - NLCD (2011)

Landcover Class	Acres	Total Area (%)
Open Water	22	0.2
Developed- Open Space	987	8
Developed- Low Intensity	821	7
Developed- Medium Intensity	369	3
Developed- High Intensity	114	1
Barren Land	11	0.1
Deciduous Forest	6105	50
Evergreen Forest	29	0.2
Mixed Forest	22	0.2
Herbaceous	17	0.1
Hay/Pasture	3300	27
Cultivated Crops	393	3

## CURRENT WATER QUALITY IN THE KISKIMINETAS WATERSHED AREA OF INTEREST

### Non-point source pollution

In all, the Pennsylvania Department of Environmental Protection identified 7.55 stream miles as “attaining” their designated uses of providing a potable water supply and supporting aquatic life, 38.9 stream miles as “non-attaining” for those specific designated uses, and the remaining are unclassified. The majority of streams that drain this watershed are considered “impaired” for aquatic life. Identified impairments include nutrients and siltation from agricultural land, as well as runoff and nutrients from residential/urban areas within the watershed. These are considered non-point sources, originating not from one identifiable point but instead from diffuse sources across the landscape.

### Kiskiminetas Area of Interest Attaining and Impaired Streams

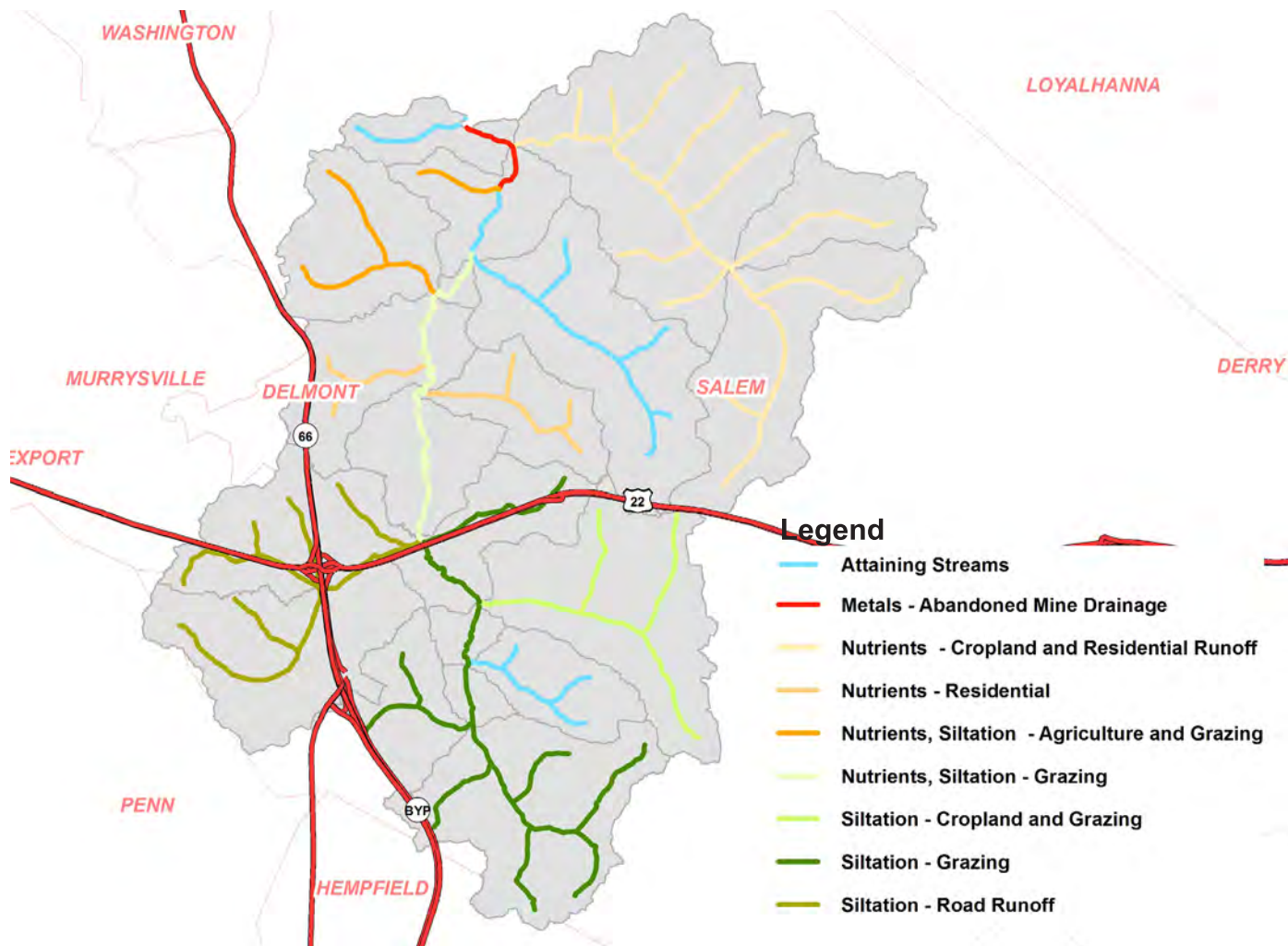

### TMDL status of the streams in this area of interest

All of the streams in the Kiskiminetas Area of Interest are under a TMDL, (Total Maximum Daily Load) agreement, The “*Kiskiminetas-Conemaugh River Watersheds TMDL.*” This TMDL is a seeks to reduce non-point sources of pollution from Metals/ high pH (from Abandoned Mine Drainage) as well as Siltation and Suspended Solids. The other impairment sources are not addressed by TMDL agreements.

Abandoned Mine sites include regions of subsidence, abandoned structures and entries, and abandoned mine drainages. In particular, the drainages contribute to poor habitat and water quality.

Source - PA DEP



## WATER QUALITY AND WATER QUANTITY ARE INEXTRICABLY LINKED IN THE KISKIMINETAS WATERSHED AREA OF INTEREST

As water accumulates and moves overland on impervious surfaces, it picks up pollutants from the surface of the landscape and delivers it to receiving waters. Development, particularly that which increases impervious surfaces on the landscape, increases the overland flow of water during storms and decreases infiltration to groundwater. Increased stormwater also increases the erosive force of overland flow, increasing sediment load and delivering it to downstream receiving waters. Below, a watershed map shows the concentration of impervious surface in the area of Delmont and the highway.

### Kiskiminetas Area of Interest Impervious Cover (%)

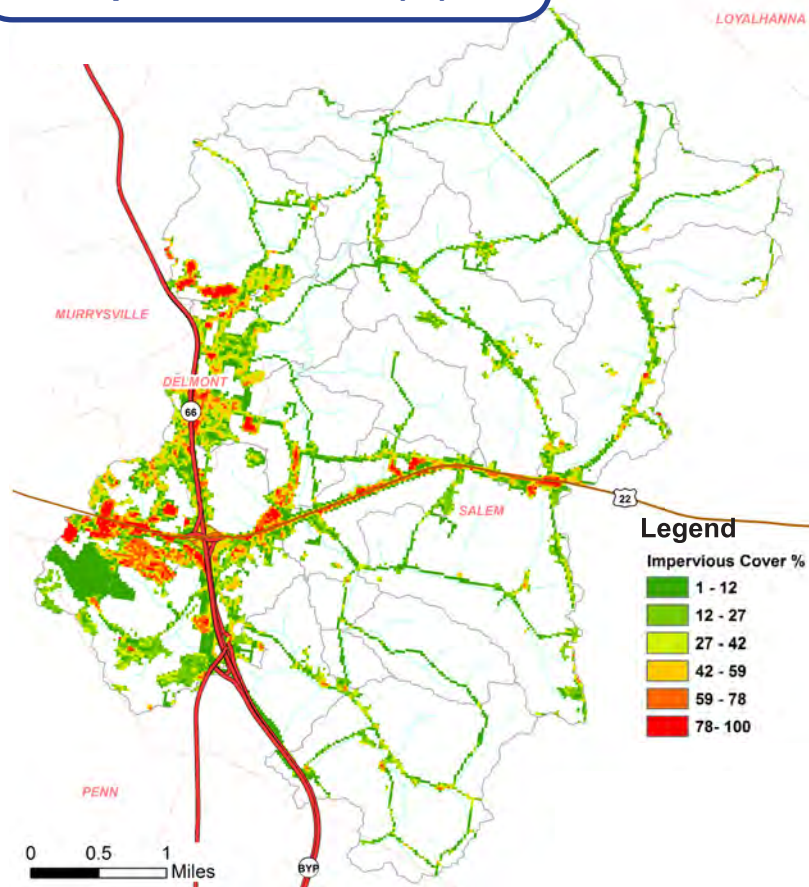

Beaver Run - Sediment Bar

As stormwater runoff increases, so does the water's capacity to carry sediment and nutrients such as Nitrogen and Phosphorus. Stormwater may drop sediment and pollutants when the flow/energy of the water decreases. Above, we can observe this process where Beaver Run empties into Beaver Run Reservoir. The aerial image of the site clearly shows a sand/sediment bar at the mouth of Beaver Run. The swiftly moving stream water slows as it enters the reservoir and the water deposits sediment and associated pollution.

Both the sediment and the pollution are a threat to water. Accumulated nutrients can lead to harmful algae blooms, which may affect wildlife and water quality in the reservoir. The sediment accumulation represents the erosion, and loss, of valuable soil from upstream landscapes. The sediment is also a threat in the future as it continues to accumulate and reduces the available water holding capacity of the reservoir.

Source - Westmoreland County

Source - NLCD



## FUTURE TRENDS IN THE KISKIMINETAS WATERSHED AREA OF INTEREST

This watershed will likely see increasing development and a reduction in forested and agricultural land. These land-use trends will likely add to stormwater runoff and non-point pollution loadings.

There is tremendous opportunity to carefully plan now in order to mitigate the potential increase in flooding and pollution delivery downstream. The projections below are compiled from the ESRI GREEN INFRASTRUCTURE Online Mapping tool, developed in conjunction with the Clark Labs (<http://www.esri.com/about-esri/greeninfrastructure>).

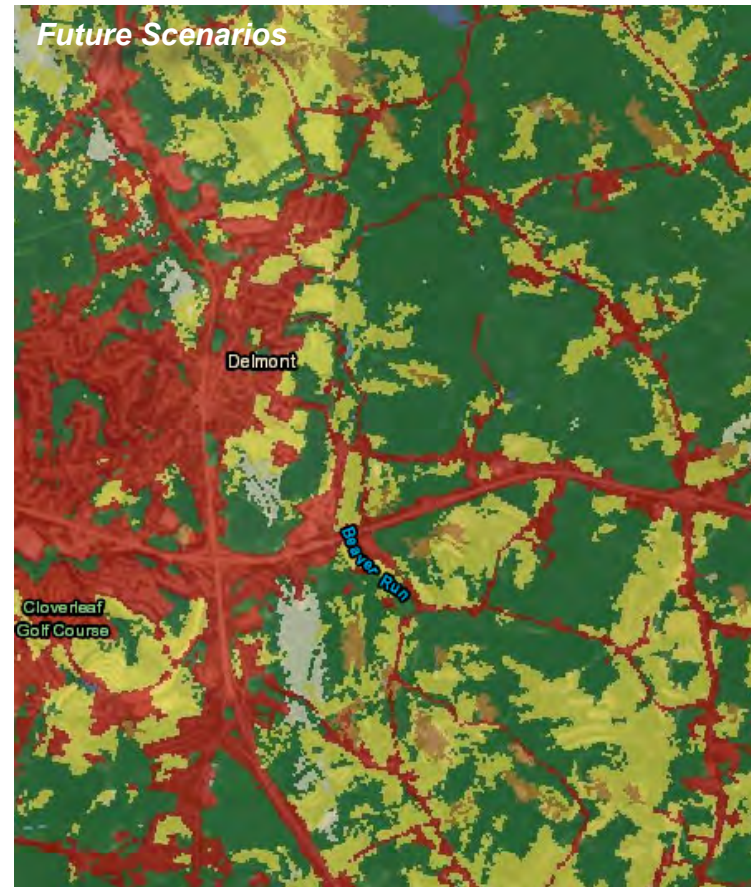
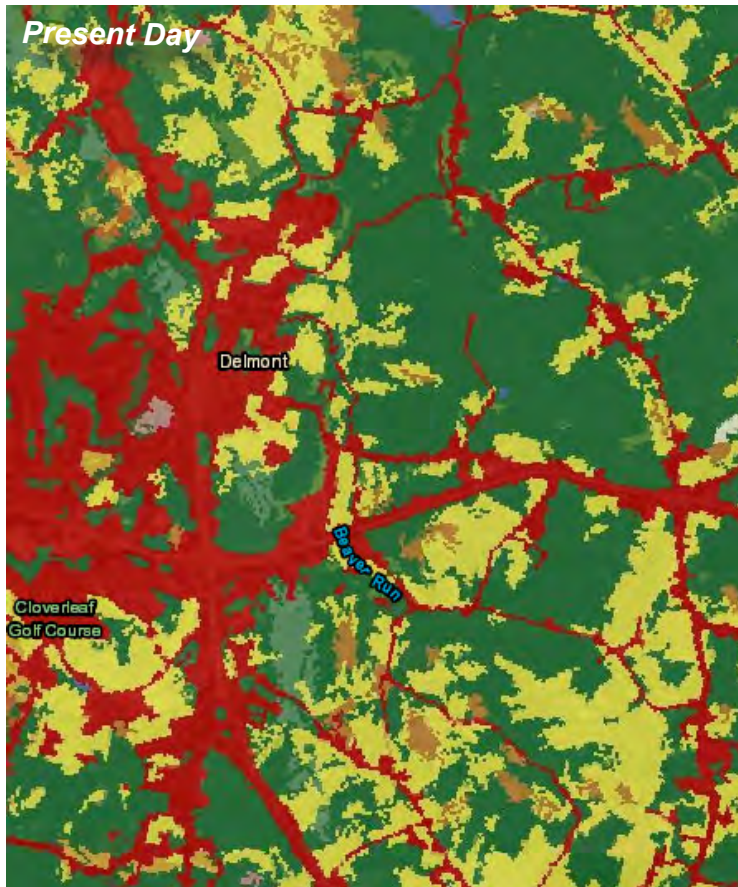

### Legend

National Land Cover Database

 Open Water	 Scrub/Shrub
 Perennial Ice/Snow	 Grassland/Herbaceous
 Developed	 Pasture/Hay
 Barren Land (Rock/Sand/Clay)	 Cultivated Crops
 Forests	 Herbaceous and Woody Wetlands

### Specific predictions of change in land-use

Above, a visual comparison of land use in 2011 versus predicted land use in 2050 highlights the forecasted increase in impervious surfaces. This analysis of land use change in the Kiskiminetas Area of Interest specifically estimates

- A 22% *INCREASE* in developed land,
- A 8% *DECREASE* in forest cover
- A 14% *DECREASE* in agricultural cropland

Source - ESRI



# HYDROLOGIC WATERSHED MODELING: INPUT PARAMETERS, MODEL CALIBRATION & FINAL RELEASE RATES FOR THE KISKIMINETAS WATERSHED AREA OF INTEREST

Controlling water now and in the future requires an understanding of current conditions and pollution sources. The **Parameters** below and on the following pages were used in hydrological models to help us understand the contribution of different sub-watersheds to the flow of the whole, and possible future changes.

**Hydrologic Soil Groups in the Kiskiminetas Watershed Area of Interest** The map below is color-coded by the Hydrologic Soil Group, which indicates a soil's water holding capacity. Group A soils have low runoff potential and high infiltration rates, while Group D soils show the highest runoff potential with very low infiltration rates. Also shown are the specific soil names, please see appendix for a list and descriptions of individual soil types.

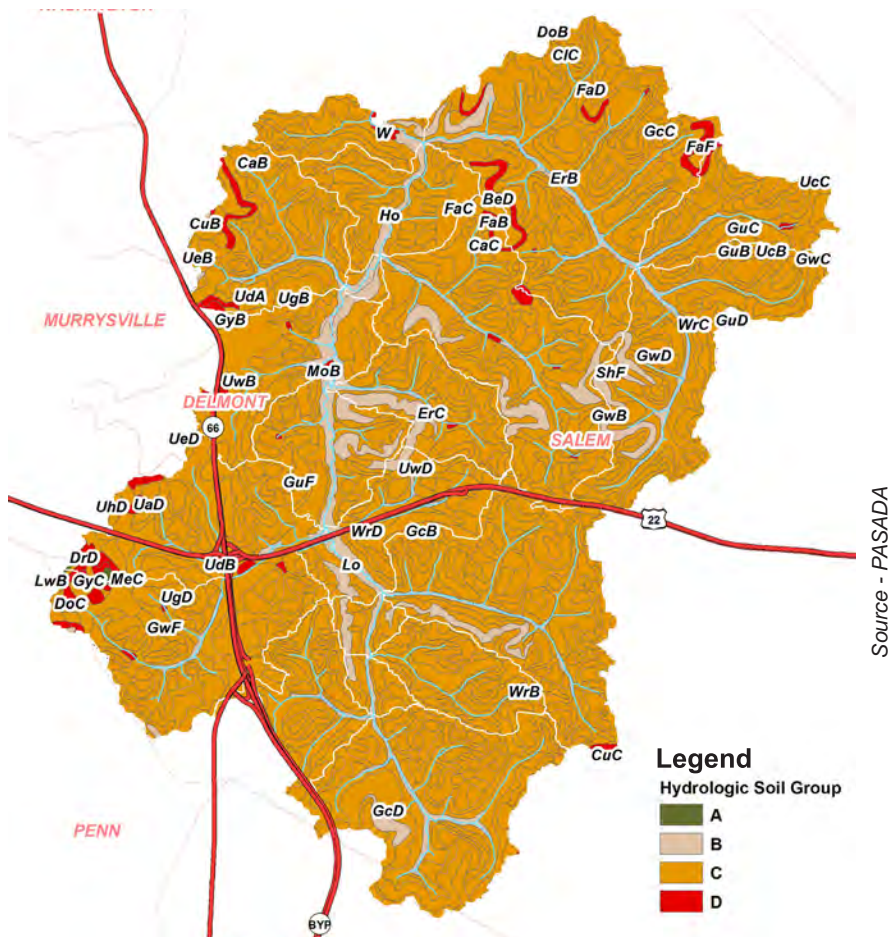

**Basin Curve Numbers ("CN's") in the Kiskiminetas Watershed Area of Interest** are an empirical parameter that help predict direct runoff/infiltration from a parcel of land during a rain event. In the Kiskiminetas are of interest, these range from 65 to 78. Watersheds with a higher curve number indicate higher runoff potential, leading to greater flooding and pollution delivery to streams.

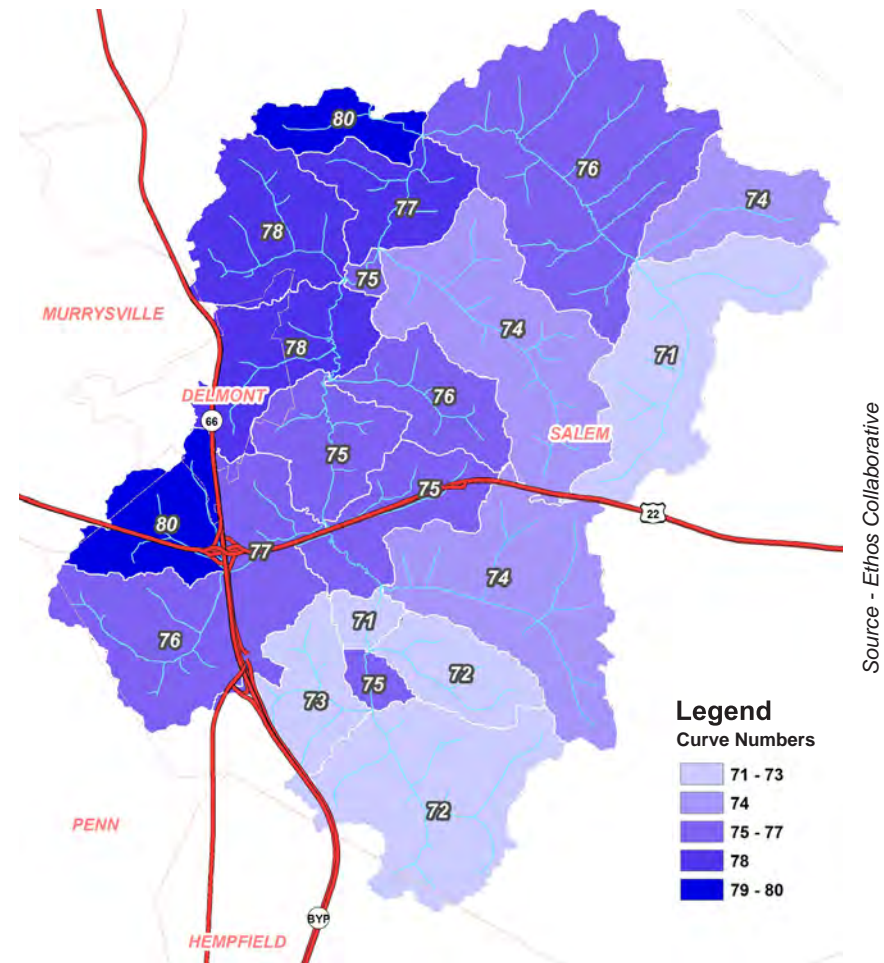



**Average Basin Slope (%) in the Kiskiminetas Watershed Area of Interest** Generally most regions in this watershed show a moderate slope, with a range of values from 16.37% to 32.29%. Steeper slopes are found in the stream valleys and shallower slopes on the upland regions. Slope steepness contributes to overall runoff calculations, as steeper regions generally experience greater runoff during rain events.



**The Basin Storage Ratio in the Kiskiminetas Area of Interest** indicates the proportion of each sub-watershed that can store water in a storm, instead of directly increasing stream discharge. Storage areas include lakes, ponds and floodplains. Storage ratios range from 0.0008 to 0.1999, therefore the storage amount available in each sub-watershed varies from 0.08-20% of the sub-watershed area.

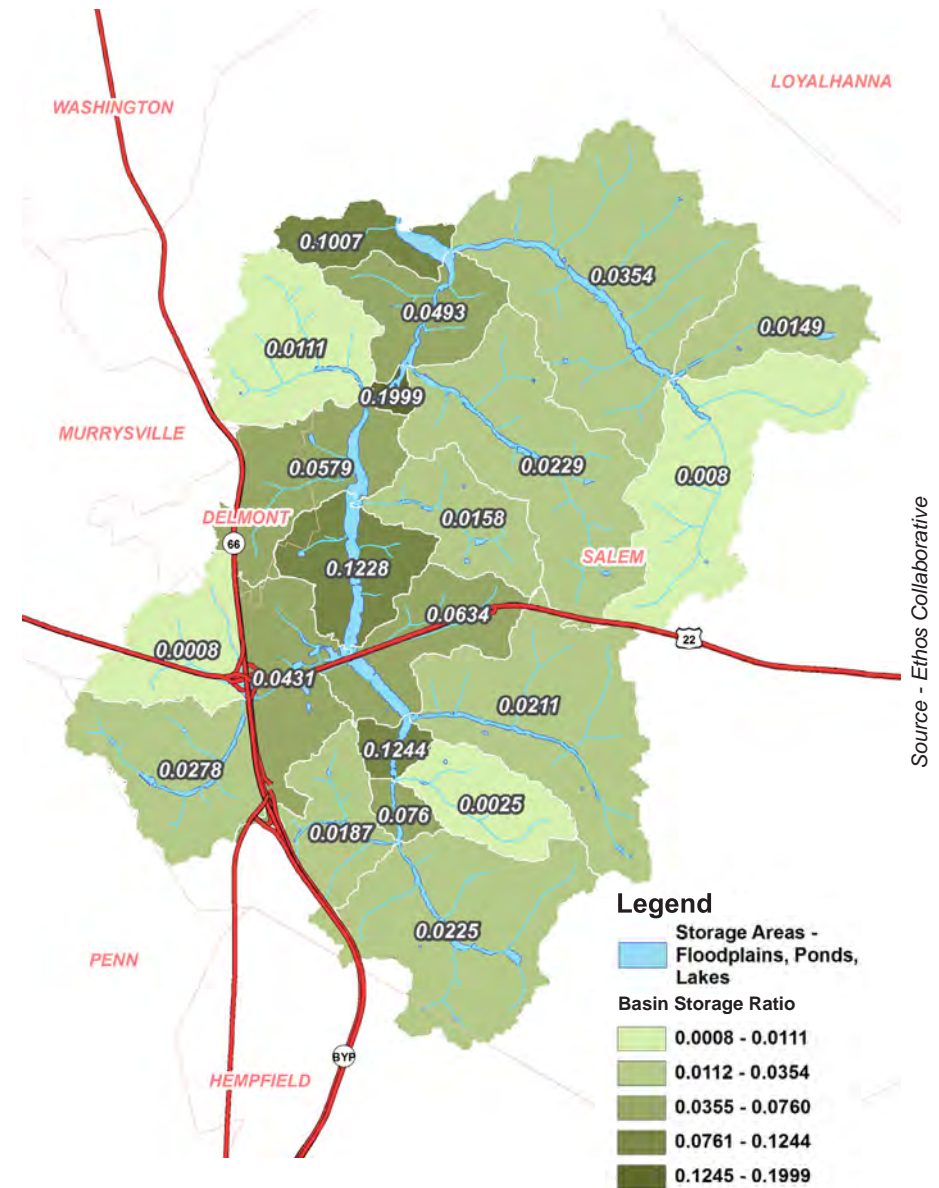

Source - Ethos Collaborative



## MODEL CALIBRATION IN THE KISKIMINETAS WATERSHED AREA OF INTEREST

Six sites were chosen as “areas of interest” and model results at these sites were compared to Stream Stats data for the same site. This approach allowed the calibration of hydrological models, in the absence of multiple stream gage locations in the watershed. The graphs below show how each point of interest compares for the 2, 5, 10, 50, and 100 year storms. There is a good correlation between model results and Streams Stats data. For the methodology used for calibration, validating statistics and comparisons refer to the methodology in the appendix.

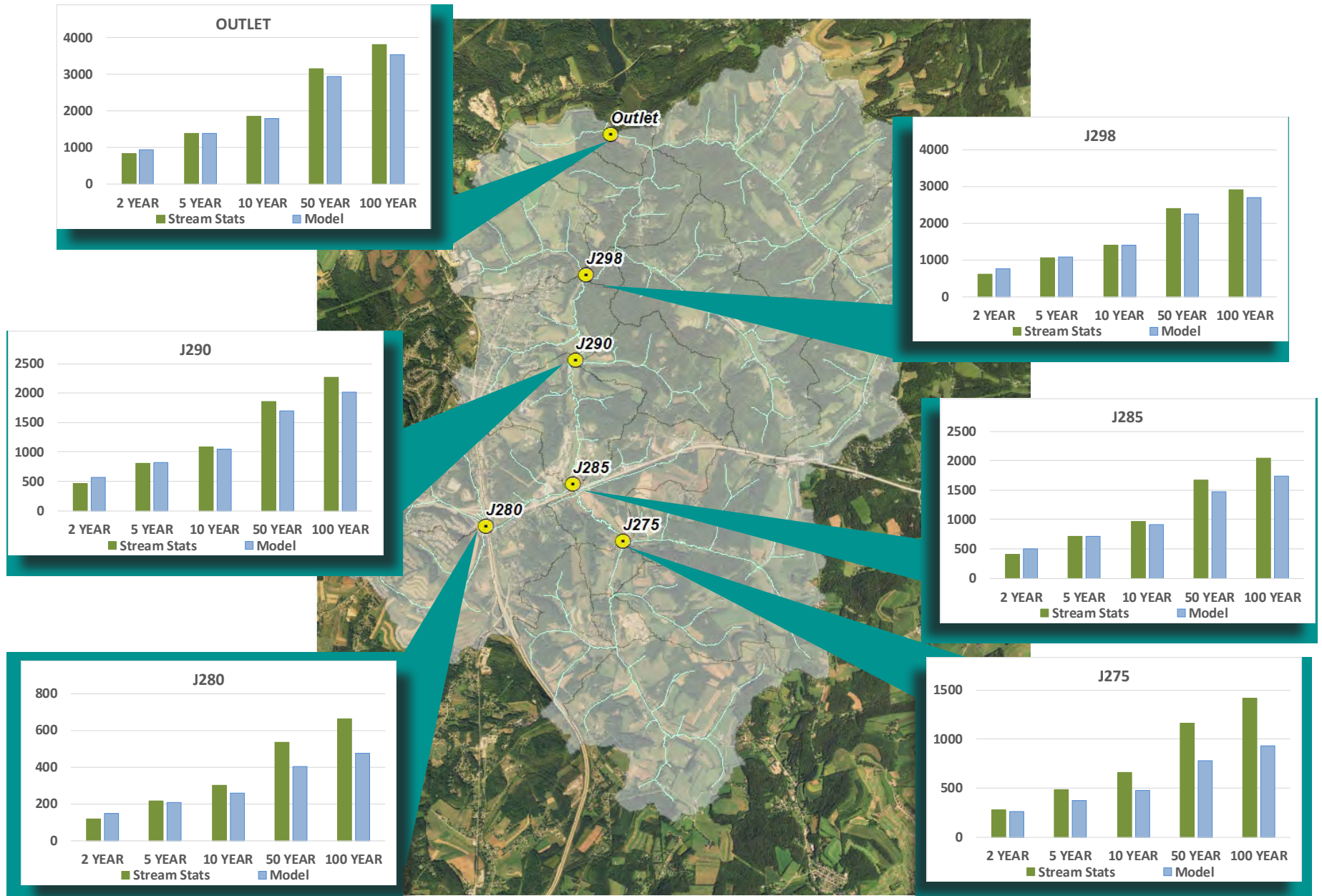

Source - Ethos Collaborative

## RECOMMENDED RELEASE RATE MAP FOR THE KISKIMINETAS WATERSHED AREA OF INTEREST

Release rates are a tool that help determine the timing of when water can be released from a watershed. A release rate of 50% for a sub-watershed indicates that the rate at which stormwater moves out of the watershed and downstream must be reduced by half in any future development. In contrast, a release rate of 100% indicates that, with future development, stormwater can move off of the sub-watershed at the same rate that it does in the present. In other words, lower release rates require an increased control of runoff.

Release rates were calculated based on a hydrologic model of the area of interest using HEC-HMS, the U.S. Army Corps of Engineers (USACE) Hydrologic Modeling System, in conjunction with GEO-HMS (a GIS extension that allows for the manipulation of spatial data).

Final calculated release rates show a range in value from 50-100%. Darker colors and lower release rates indicate regions where future development must reduce runoff rates.

It should be noted that the methodology to calculate release rates focuses on the basin-wide contribution of upstream land on downstream flooding. **In order to control more localized flooding, individual municipalities may enact stricter stormwater runoff controls.**

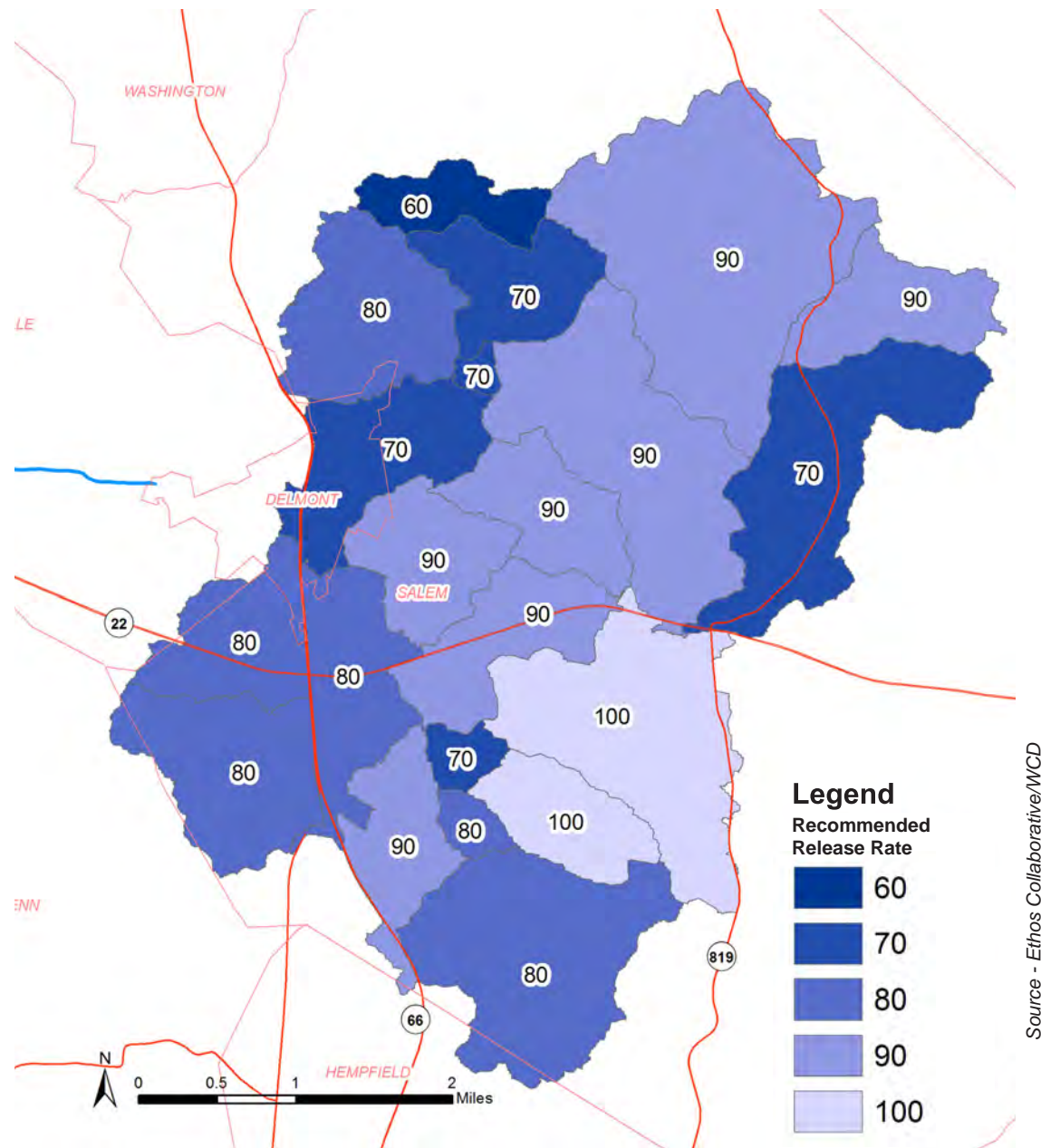



## LANDSCAPE POLLUTION ACCUMULATION MODELING

To understand where and how pollution-bearing runoff moves across the landscape, we modeled accumulation using ArcGIS in conjunction with a specialized terrain analysis toolset, (TAUDEM). This analysis allowed us to understand both pollution contributions and pollution reductions due to the underlying landscape. Please see the Methodology Appendix for further details about this process.

### TOTAL SUSPENDED SOLIDS (TSS)

Sediment, or Suspended Solids, encompasses any number of particulate pollutants or natural particles, from a myriad number of sources. Shown to the right is the estimated sub-watershed export of sediment, in pounds per year.

- The high percent of impervious surfaces in the town of Delmont and the nearby highway interchange collect solids during dry weather and then during wet weather contribute to high TSS loads draining from these watersheds. These sub-watersheds have little in the way of riparian buffers or other landscape features that help to slow, infiltrate, and absorb water, preventing it and associated pollutant loads from moving into the stream, and subsequently downstream.
- Significant contributions of TSS are also found in sub-watersheds where agricultural activities such as grazing and plowing take place. These regions in particular would benefit from the increase in riparian buffers as a way to capture water and associated pollutants before it reaches the stream.

### Kiskiminetas Area of Interest Annual Sediment Loading (lbs per acre per year)

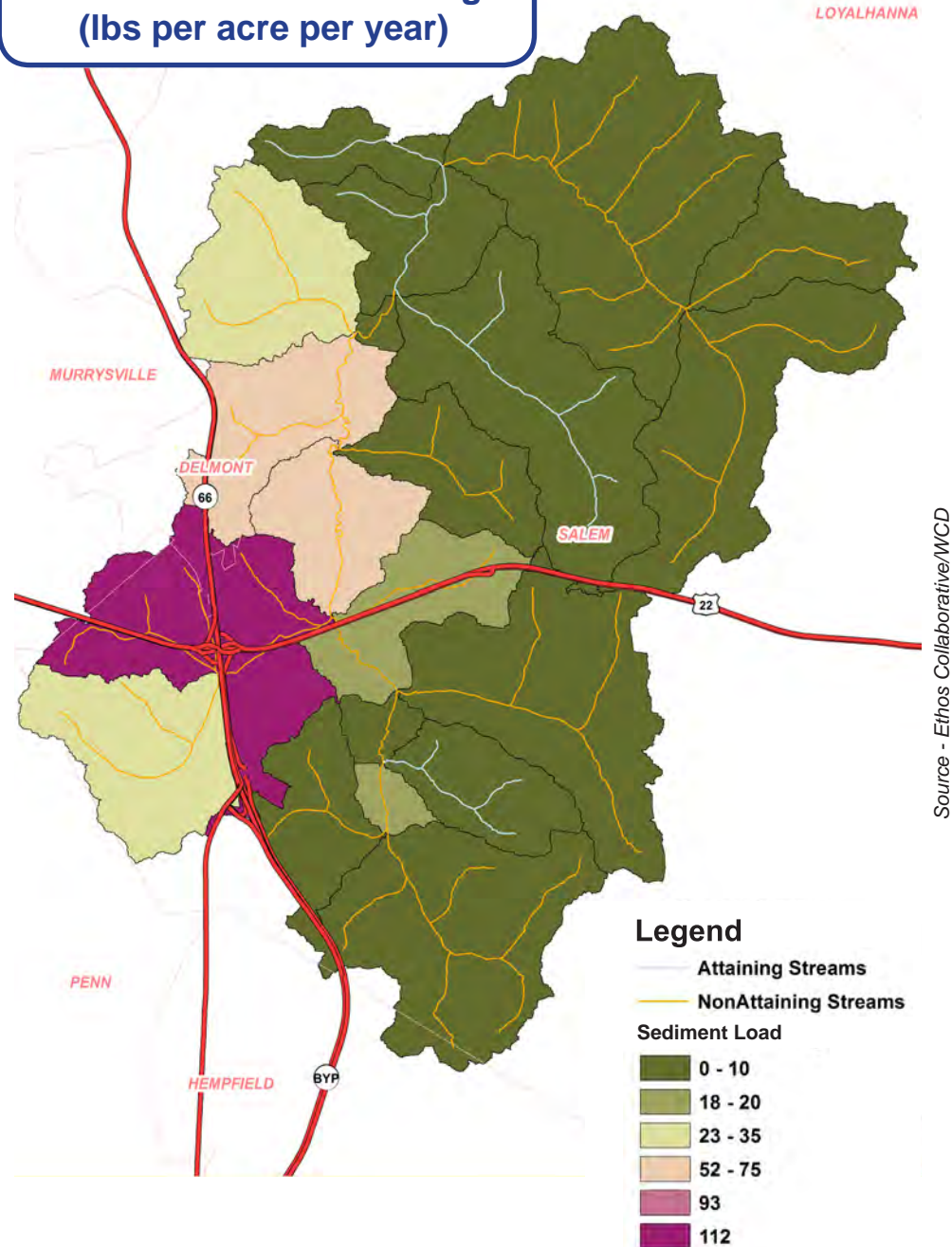

## Kiskiminetas Area of Interest Annual Nitrate Loading (lbs per acre per year)

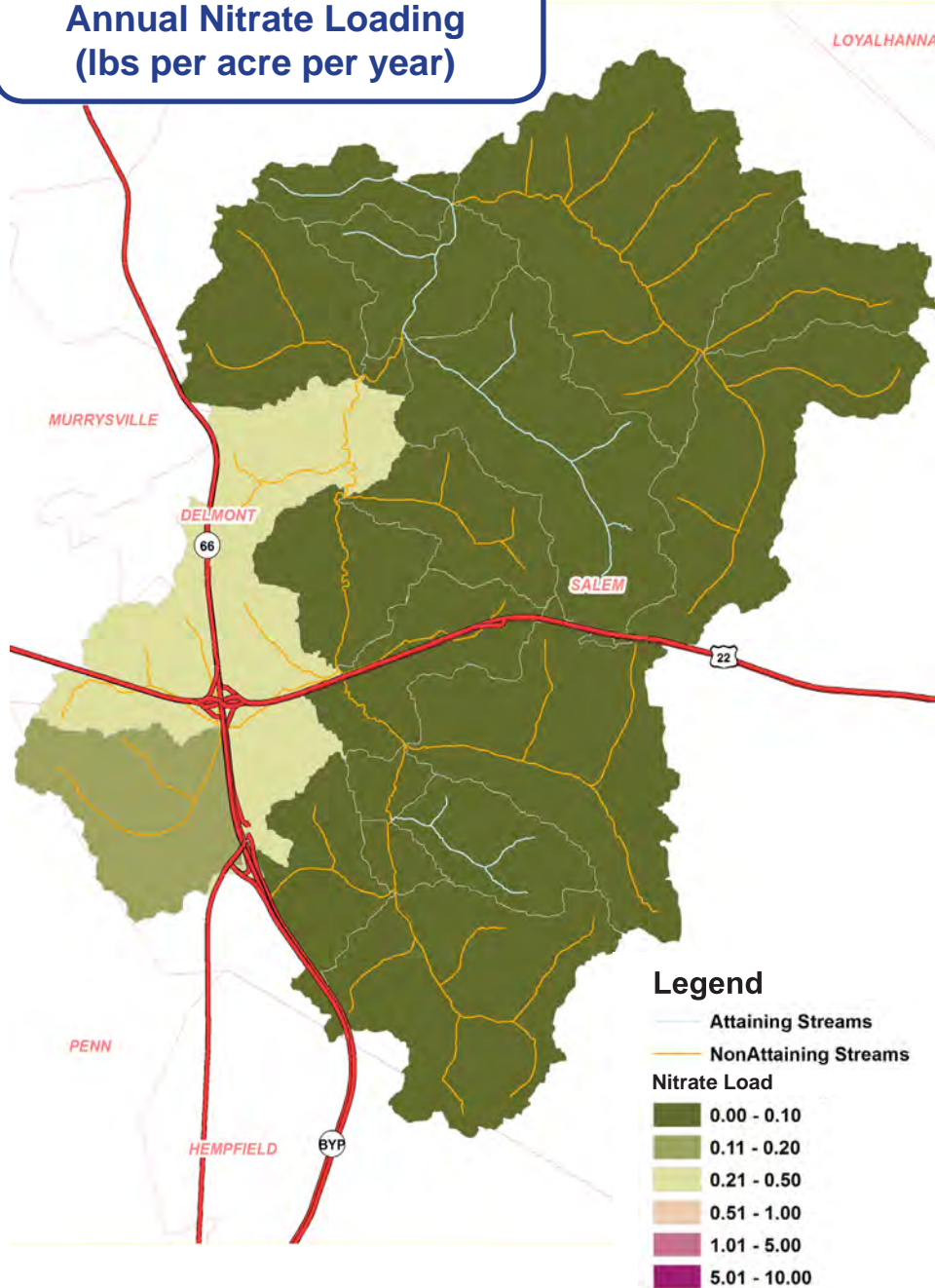

Source - Ethos Collaborative

### NITRATE (TNO3-)

Nitrogen, here expressed as nitrate ( $\text{NO}_3^-$ ), is a nutrient essential for plant and animal growth. Historically, biologically available nitrogen was a limiting factor in ecosystems, however industrial activities have increased biologically available nitrogen to the point where it is now considered a pollutant in many regions. Shown on the map to the right is the modeled sub-watershed export of nitrate, in pounds per year.

- Agricultural activities and residential areas both contribute fertilizer-sourced nitrogen to the watershed. Fertilizer applied to croplands and residential lawns can be washed from the land surface into streams.
- Nitrogen can be found in urine excreted from grazing animals. Urine-sourced nitrogen is biologically transformed to nitrate, which can then be transported downstream.
- Fixed nitrogen is emitted to the atmosphere when fossil fuels are burned. This nitrogen is deposited as nitrogen oxides or  $\text{NO}_x$ , on the landscape, with concentrations found in near-road areas.
- Wastewater contains biologically available nitrogen. Wastewater treatment plants may not remove all of the nitrogen before treated water is discharged to streams. Septic systems may contribute biologically available nitrogen to groundwater.



**Kiskiminetas Area of Interest  
Annual Phosphorus Loading  
(lbs per acre per year)**

**TOTAL PHOSPHORUS (TP)**

Phosphorus, here expressed as Total Phosphorus (TP) is a nutrient essential for life. Phosphorus, like Nitrogen, used to be a limiting nutrient for ecosystems. Industrial activities and fertilizer both contribute excess phosphorus to ecosystems. This phosphorus contributes to algae blooms in water bodies, eutrophication, and overall habitat deterioration. Shown on the map to the right is the modeled sub-watershed export of TP in pounds per year.

- Higher amounts of phosphorus are exported from the urban sub-watersheds in the Kiskiminetas AOI. Phosphorus is sourced primarily from lawn fertilizer and roadway deposition. These sources produce both particulate and dissolved forms of phosphorus.
- Soil erosion is another contributor of phosphorus to streamwater. Erosion depletes the soil of valuable nutrients like phosphorus and transports the nutrient downstream,.
- Crops lands export Phosphorus to downstream environs, sourced from fertilizer applied to the fields. Fertilizer-sourced Phosphorus is likely in particulate forms, and therefore structural BMP's that filter and/or detain sediment and particles can help to mitigate downstream export.
- Wastewater contains phosphorus from human waste and detergents. Wastewater treatment plants may not remove all of the phosphorus before treated water is discharged to streams.

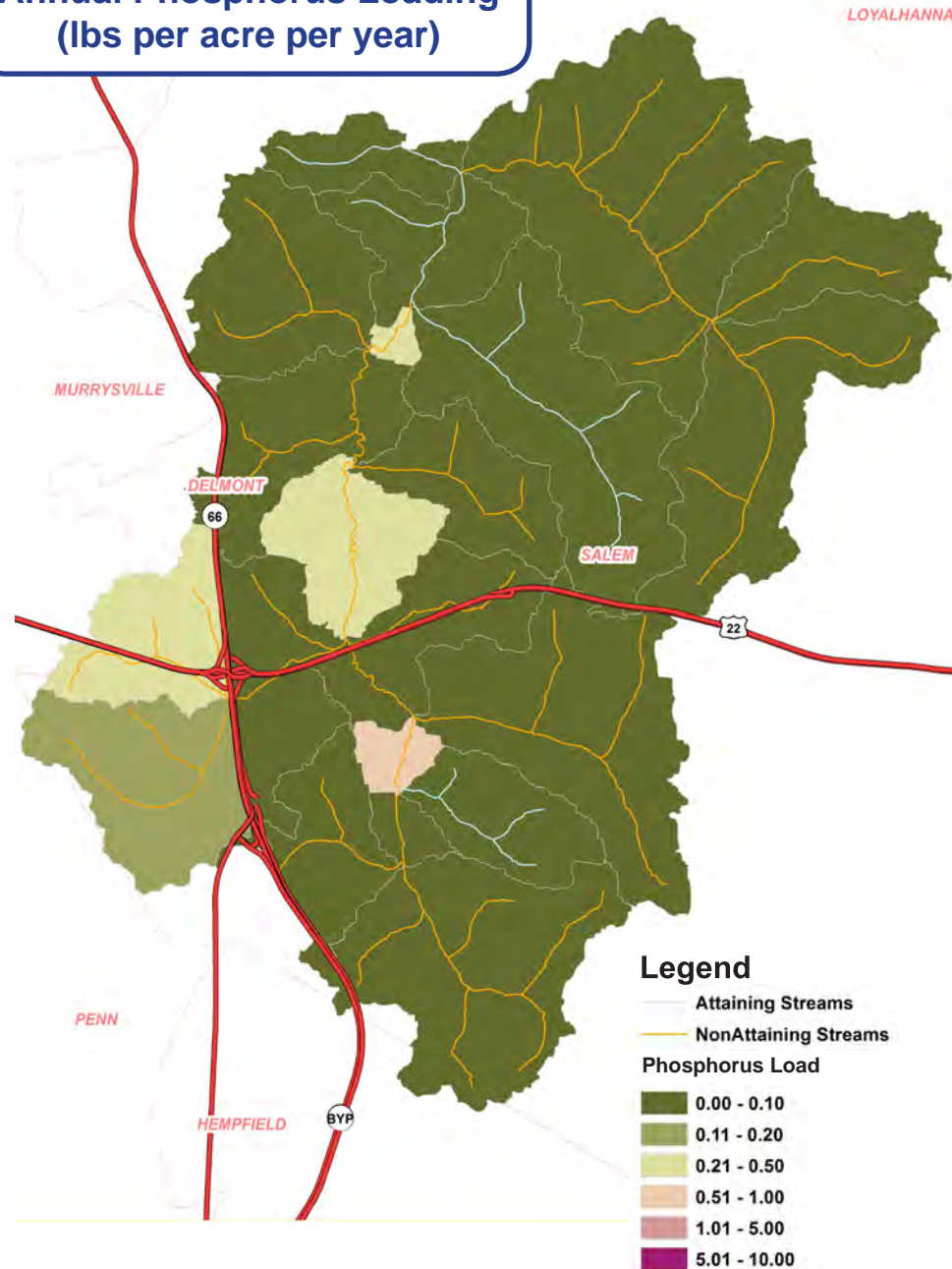

Source - Ethos Collaborative

# OPPORTUNITIES FOR EFFECTIVE STORMWATER MANAGEMENT

Based on modeling watershed hydrology and pollution sources to inform smart water management.

## Effective water management protects valuable resources and built infrastructure.

The drinking water sourced from Beaver Run Reservoir and the soil used in agricultural lands in this watershed are both valuable resources that must be conserved for future generations. Conservation efforts should consider ways to manage water runoff that decrease soil erosion, pollution transport, and sedimentation in the reservoir.

## To increase water quality, we must decrease overland water quantity.

Water detained by increasing infiltration to groundwater encourages nutrient retention, or the uptake and filtration of pollutants by biota and soil. Together, the processes of detention and retention increase water quality through decreasing erosion and downstream transport.

## Conceptual Ideas for BMP's/Landscape Restoration: Highlighting the potential for water and pollutant capture and retention.

Identified issues include stormwater runoff and associated erosion, as well as the identification of sites appropriate for Green Infrastructure such as stormwater retrofits, riparian buffer restoration, and stream restoration. When coupled with the landscape-based nutrient accumulation and decay modeling, this list can help to identify and prioritize projects for future conservation efforts.

## Opportunities for Effective Stormwater management

Three sites in the Kiskiminetas Area of Interest with known stormwater or water quality issues are identified below. This list was compiled based on reports made by local property owners to the Westmoreland Conservation District and should by no means be considered an exhaustive list of problem sites in the watershed.

### Kiskiminetas Area of Interest Conceptual Opportunities

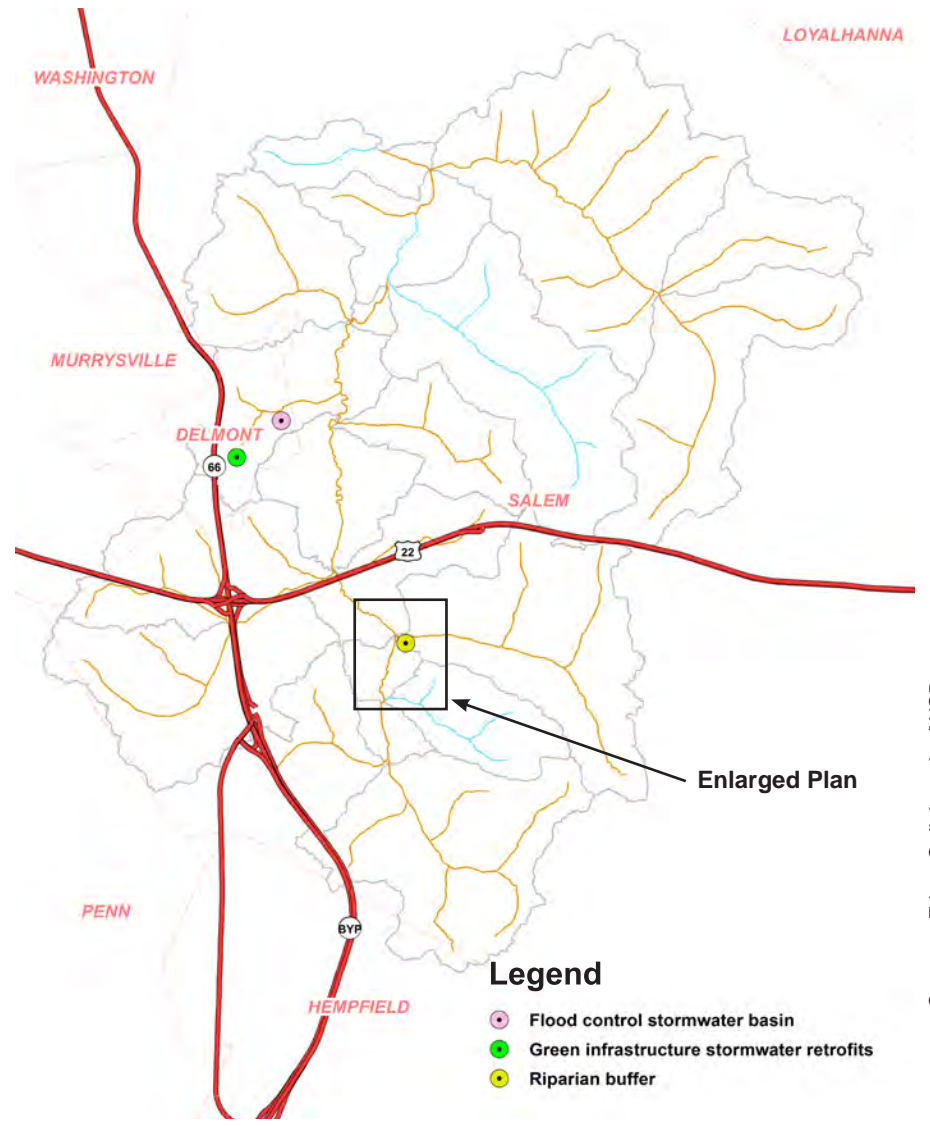

Source - Ethos Collaborative/WCD



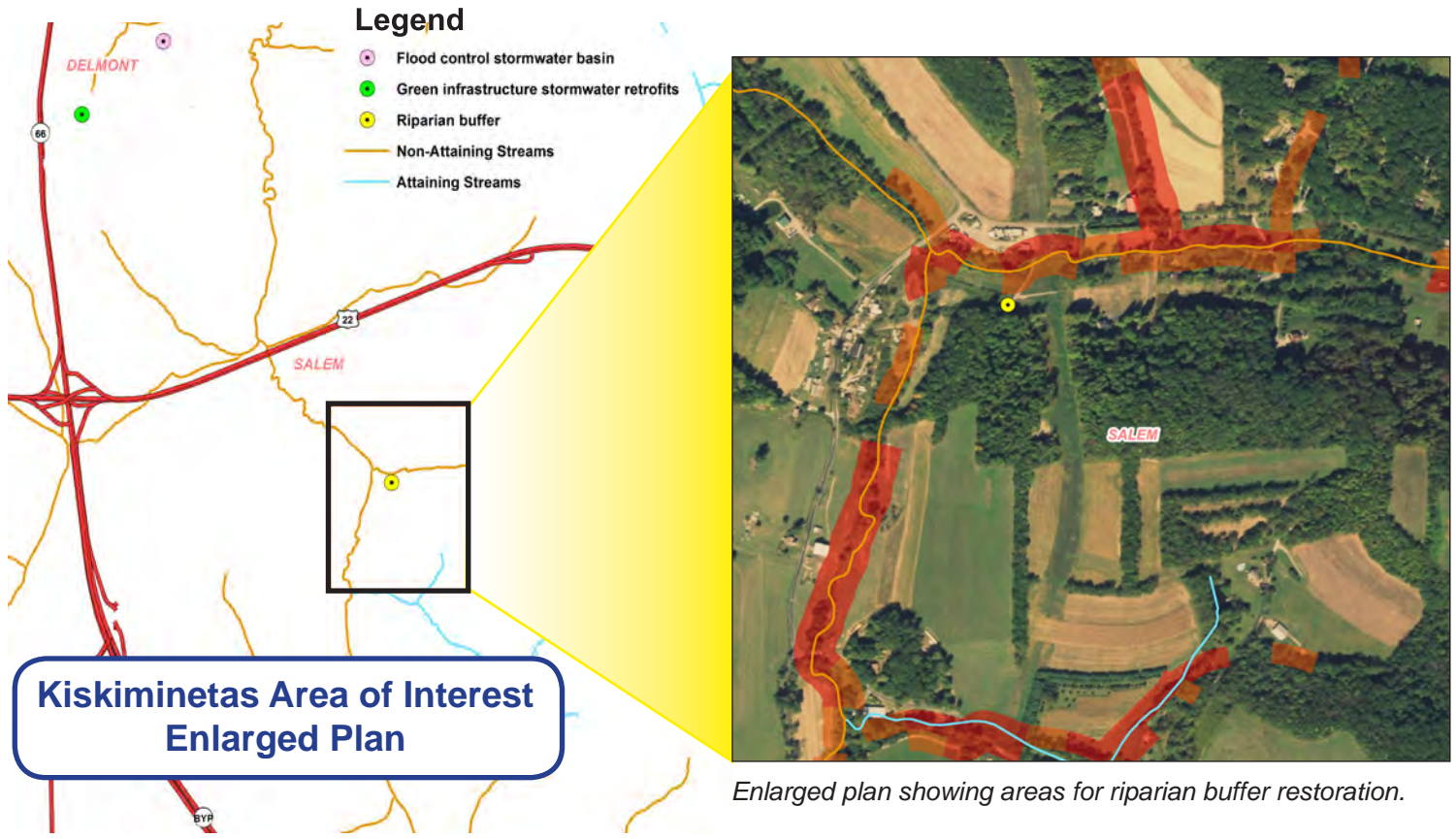

Source - Ethos Collaborative

**CONCEPTUAL OPPORTUNITY IN THE KISKIMINETAS AREA OF INTEREST: RIPARIAN BUFFER RESTORATION**

This area is located in Salem Township, near the Route 22/Route 66 highway interchange. Two tributaries come together to form the main stem of Beaver Run. The stream reach moving through this area drains a region of open land and farm fields.

**Water Quality Goals:**

During rain events, water flows across the farm fields and pastures into the stream network. This water can increase downstream flooding, as well as deliver sediment and fertilizer-sourced pollution including dissolved and particulate Suspended Solids (TSS), Phosphorus (TP), and Nitrate (TNO<sub>3</sub><sup>-</sup>).

**Stormwater Management Potential:**

Identified needs include increasing the riparian buffer along the stream to mitigate the overland flow of water and sediment.

**Landscape Elements to Consider:**

The map above shows the area of interest, close-up. As indicated by the red and orange buffers on either side of the stream, there is little tree canopy in the riparian buffer.

**Water Quality Impacts of Stormwater Management:**

Augmenting the riparian buffer in these areas would help improve water quality. Increased tree canopy would slow overland flow, encouraging water and particle infiltration/settling and increasing biological processing interactions. This would help to decrease stream loads of TSS, TP and TNO<sub>3</sub><sup>-</sup> that are contributed from the landscape. Restoring/augmenting the riparian buffer on both sides of the above-ground stream would help to mitigate the influx of nutrients and sediment.

# CONEMAUGH RIVER WATERSHED AREA OF INTEREST

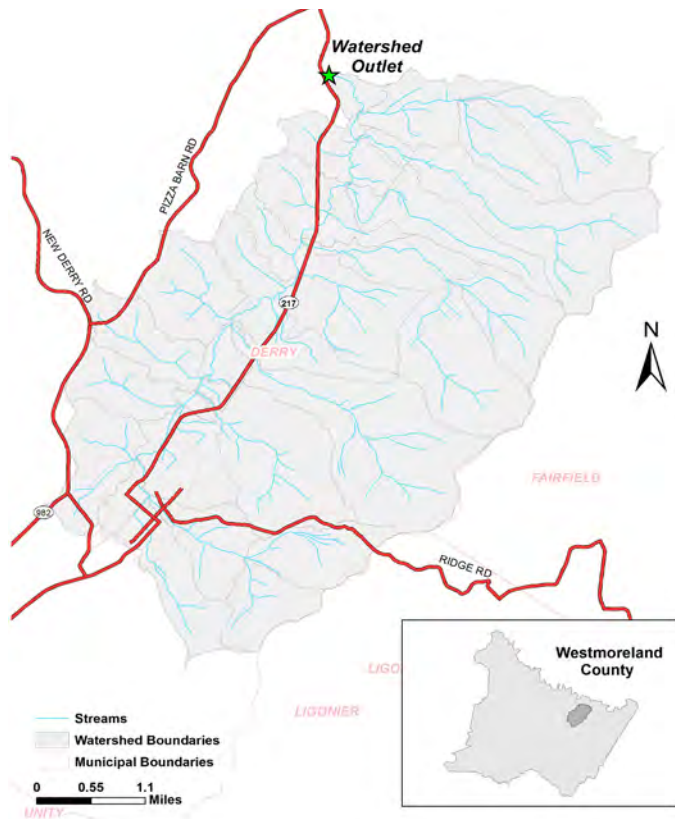

Source - Ethos Collaborative

## WATERSHED SNAPSHOT

- **Area:** 22 mi<sup>2</sup>/14,080 acres
- **Water Quality:** Impaired for aquatic life due to abandoned mine drainage, siltation, nutrients.
- **Characterization:** This area of interest is largely forested, with pockets of developed land in the Southwest corner of the watershed.
- **Derry Borough, the most densely populated region of this watershed, is currently working to reduce pollution as part of an MS4 Pollution Reduction Plan.**

## REGION OVERVIEW

The Conemaugh Area of Interest is approximately 22 mi<sup>2</sup>/14,080 acres and contains 67.9 miles of streams that drain north, eventually joining the Conemaugh River near Blairsville. The Area of Interest drains to a point on McGee Run, indicated by a star on the map to the left. Landcover in this watershed is predominantly deciduous forest and hay/pasture, with a concentration of urbanized land and associated impervious surface around the town of Derry. Thirty-one sub-watersheds were delineated ranging from 0.07 to 7.12 square miles in size. Most sub-watersheds were in the range of 0.5-1.5 square miles.

### Why is this watershed of particular interest?

This region was identified during Phase I as having recurrent flooding problems, particularly upland tributaries in Derry Township/Derry Borough. This problem will be exacerbated in the future, as further development and build-out continues. This small watershed has great potential for rapid development. The largely rural landscape leaves room for future expansion of residential or industrial areas. The lovely landscape and outdoor amenities draw visitors and residents alike. There is tremendous opportunity to carefully manage future development and stormwater planning in this area.

### Assets in the Watershed

The town of Derry is the primary urbanized area in this watershed. Derry Borough released a Pollution Reduction Plan in July of 2017, detailing the pollution reduction goals for three specific sub-watersheds. Current efforts are underway to reduce the pollutants from entering surface waters through Derry's municipal separate sanitary sewer system, or MS4. Proposed efforts include several sections of streambank stabilization in the urbanized center of Derry, conversion of existing swales to bioswales, and additional detention basins. Restoration efforts in this watershed should coordinate with Derry planners.



## Conemaugh River Area of Interest Land Classification

### Landcover / Landuse

Landcover in this watershed is predominantly deciduous forest and hay/pasture, with a concentration of urbanized land and associated impervious surface around the town of Derry. Overall, the watershed has a low percent impervious surfaces (ranging from 0.2% to 32%).

Landcover data is based on the 2011 National Land Cover Dataset, created by the Multi-Resolution Land Characteristics Consortium (MRLC). Refer to [www.mrlc.gov](http://www.mrlc.gov) for methodology.

Landcover Class	Acres	Total Area (%)
Open Water	42	0.3
Developed- Open Space	741	5
Developed- Low Intensity	527	4
Developed- Medium Intensity	217	2
Developed- High Intensity	36	0.3
Barren Land	56	0.4
Deciduous Forest	10302	73
Evergreen Forest	70	0.5
Mixed Forest	7	0.05
Herbaceous	9	0.1
Hay/Pasture	1595	11
Cultivated Crops	437	3
woody wetlands	1	0.01

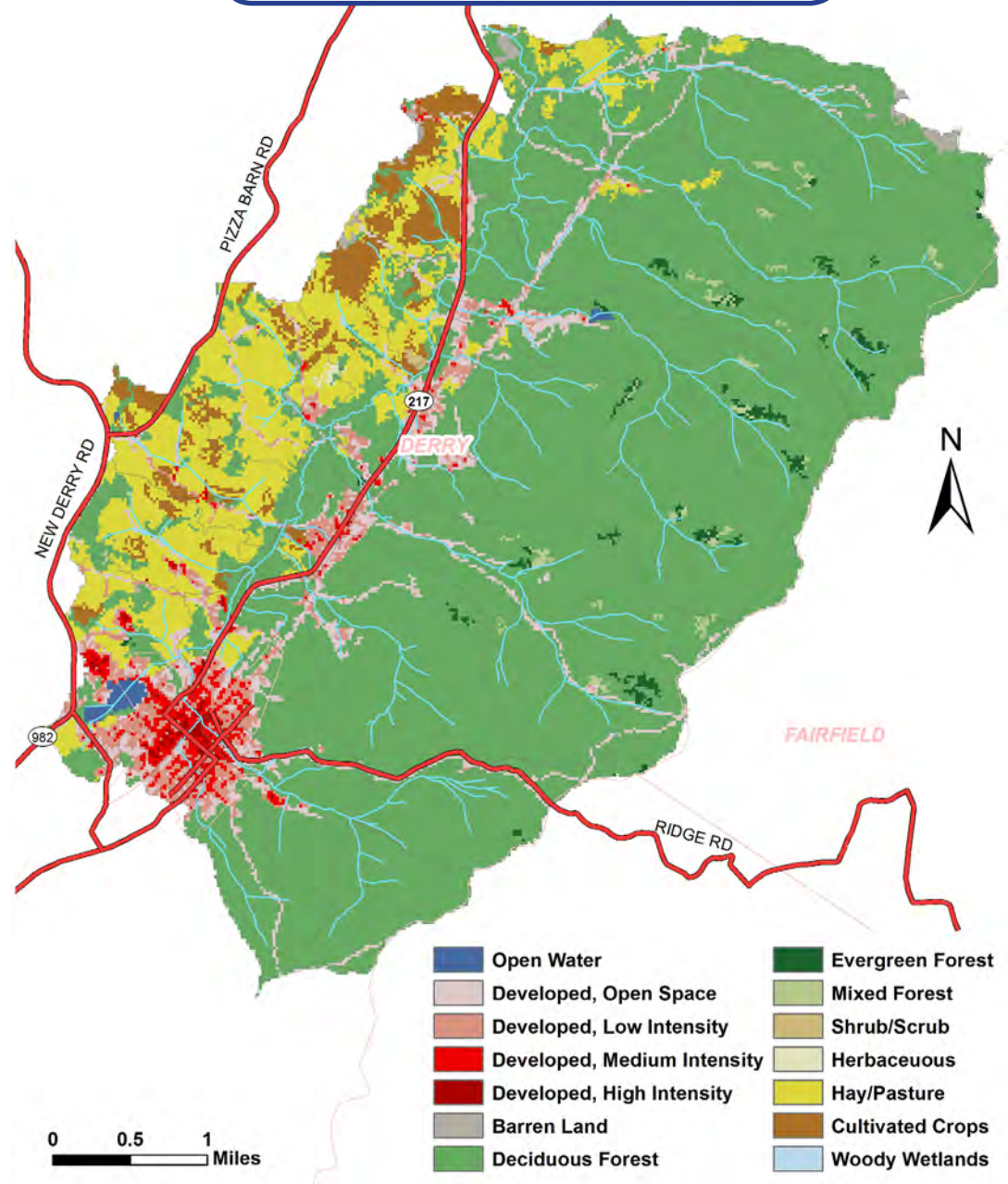

Source - NLCD (2011)

## CURRENT WATER QUALITY IN THE CONEMAUGH RIVER WATERSHED AREA OF INTEREST

### Non-point source pollution

In all, the Pennsylvania Department of Environmental Protection identified 42.8 stream miles as “attaining” their designated use of supporting aquatic life, 15.5 stream miles as “non-attaining” for that designated use, and the remaining are unclassified. Identified impairments include nutrients from on-site wastewater treatment, siltation from agricultural land, as well as runoff and nutrients from derelict lands within the watershed. These are considered non-point sources, originating not from one identifiable point but instead from diffuse sources across the landscape.

### Conemaugh Watershed Area of Interest Attaining & Impaired Streams

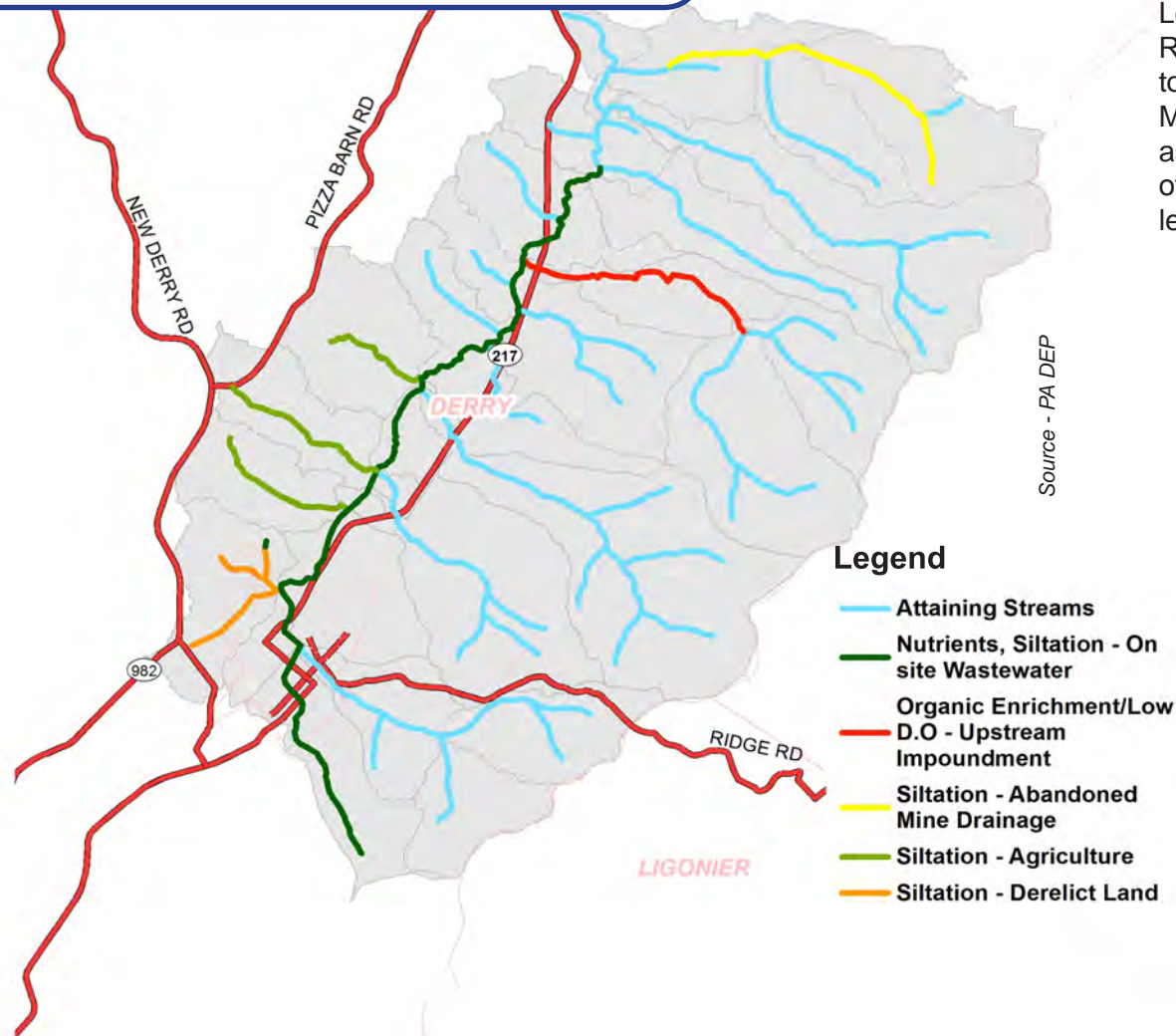

### TMDL status of the streams in this area of interest

All of the streams in the Conemaugh Area of Interest are under a TMDL, (Total Maximum Daily Load) agreement, The “Kiskiminetas-Conemaugh River Watersheds TMDL.” This TMDL seeks to reduce non-point sources of pollution from Metals/ high pH (from Abandoned Mine Drainage) as well as Siltation and Suspended Solids. The other identified impairment sources (listed to the left) are not addressed by TMDL agreements.

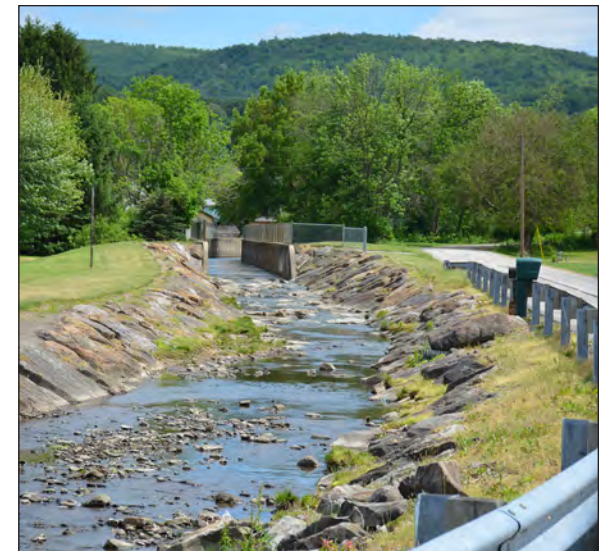

McGee Run

Photo by Mark Jackson



## WATER QUALITY AND WATER QUANTITY ARE INEXTRICABLY LINKED IN THE CONEMAUGH WATERSHED AREA OF INTEREST

As water accumulates and moves overland on impervious surfaces, it picks up pollutants from the surface of the landscape and delivers it to receiving waters. Development, particularly that which increases impervious surfaces on the landscape, increases the overland flow of water during storms and decreases infiltration to groundwater. Increased stormwater also increases the erosive force of overland flow, increasing sediment load and delivering it to downstream receiving waters. Here, a watershed map shows the concentration of impervious surface in the area of Derry and around roads.

As stormwater runoff increases, so does the water's capacity to carry sediment and nutrients such as Nitrogen and Phosphorus. Stormwater may drop sediment and pollutants when the flow/energy of the water decreases. Both the sediment and the pollution are a threat to water. Accumulated nutrients can lead to harmful algae blooms, which may affect wildlife and water quality in the reservoir. The sediment accumulation represents the erosion, and loss, of valuable soil from upstream landscapes.



Ethel Springs Lake

Photo - Derry Township

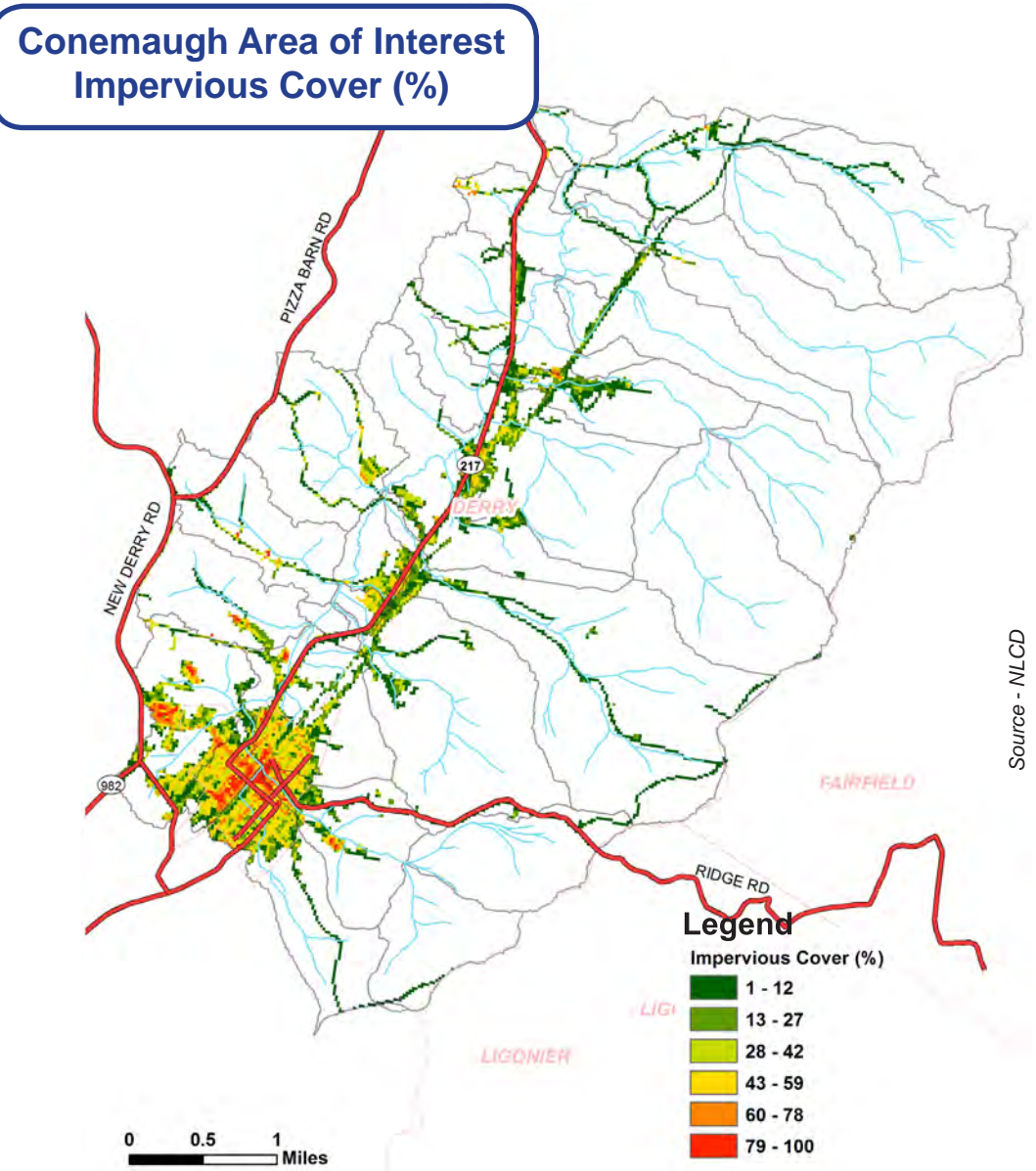



## FUTURE TRENDS IN THE CONEMAUGH WATERSHED

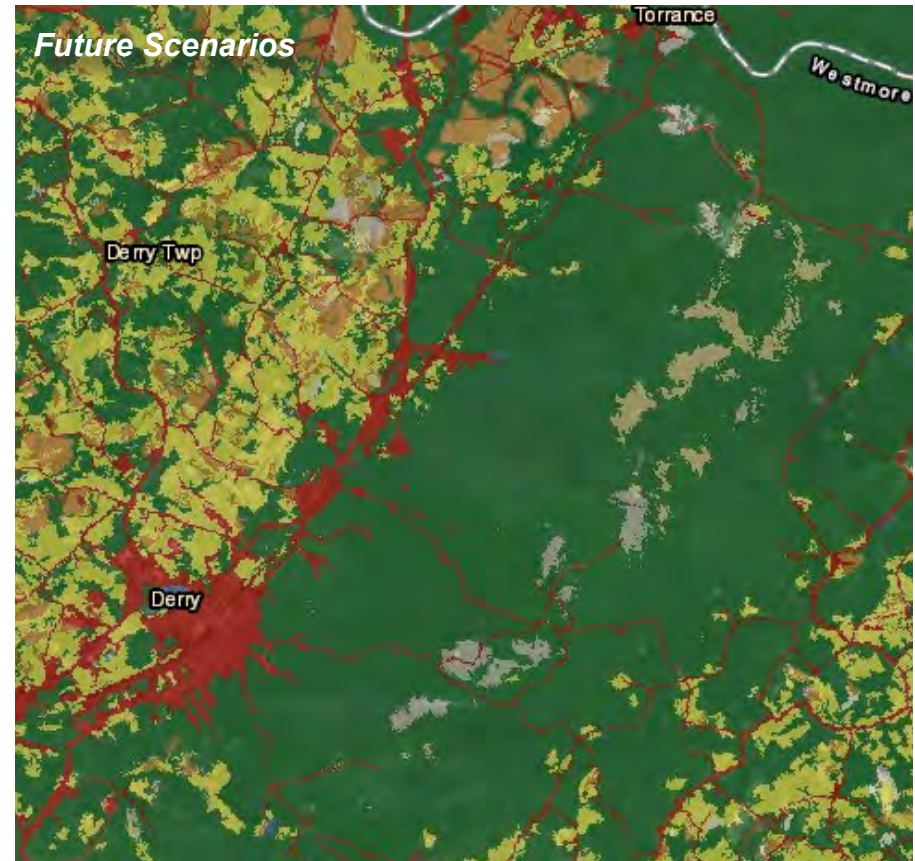
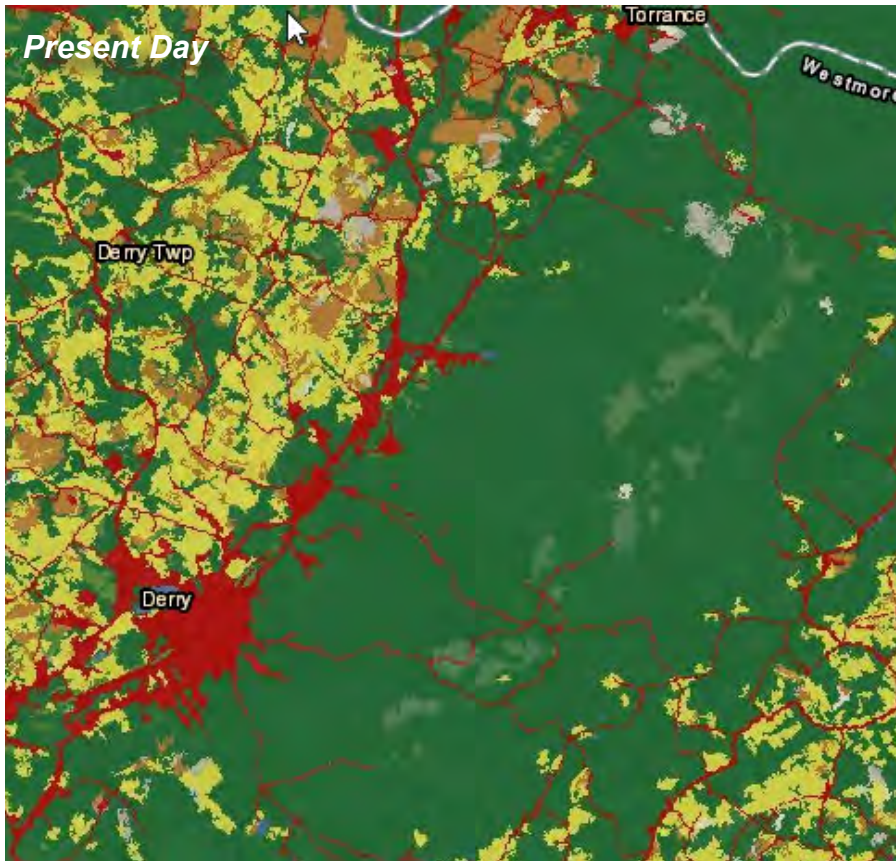

This watershed will likely see slight increases in development and accompanying slight reductions in forested and agricultural land. These land-use trends will likely add to stormwater runoff and non-point pollution loadings. Carefully planning now to mitigate the

effects of these changes will help to decrease flooding and pollution delivery downstream. The projections below are compiled from the ESRI GREEN INFRASTRUCTURE Online Mapping tool, developed in conjunction with the Clark Labs (<http://www.esri.com/about-esri/greeninfrastructure>).



### Legend

National Land Cover Database

 Open Water	 Grassland/Herbaceous
 Perennial Ice/Snow	 Pasture/Hay
 Developed	 Cultivated Crops
 Barren Land (Rock/Sand/Clay)	 Herbaceous and Woody Wetlands
 Forests	
 Scrub/Shrub	

### Specific predictions of change in land-use

Above, a visual comparison of land use in 2011 versus predicted land use in 2050 highlights the forecasted changes in landcover types. Predictions indicate only a slight increase in impervious surfaces. This analysis of land use change in the Conemaugh Area of Interest specifically estimates

- A 3% *INCREASE* in developed land,
- A 3% *DECREASE* in forest cover
- A slight 0.6% *INCREASE* in agricultural cropland

Source - ESRI



# HYDROLOGIC WATERSHED MODELING:

## INPUT PARAMETERS, MODEL CALIBRATION & FINAL RELEASE RATES FOR THE CONEMAUGH WATERSHED AREA OF INTEREST

Controlling water now and in the future requires an understanding of current conditions and pollution sources. **Parameters** below and on the following pages were used in hydrological models to help us understand the contribution of different sub-watersheds to the flow of the whole, and possible future changes.

**Hydrologic Soil Groups in the Conemaugh Watershed Area of Interest** The map below is color-coded by the Hydrologic Soil Group, which indicates a soil's water holding capacity. Group A soils have low runoff potential and high infiltration rates, while Group D soils show the highest runoff potential with very low infiltration rates. Also shown are the specific soil names, please see appendix for a list and descriptions of individual soil types.

**Basin Curve Numbers ("CN's") in the Conemaugh Watershed Area of Interest** are an empirical parameter that help predict direct runoff/infiltration from a parcel of land during a rain event. In the Conemaugh area of interest, these range from 43-81. Watersheds with a higher curve number indicate higher runoff potential, leading to greater flooding and pollution delivery to streams.

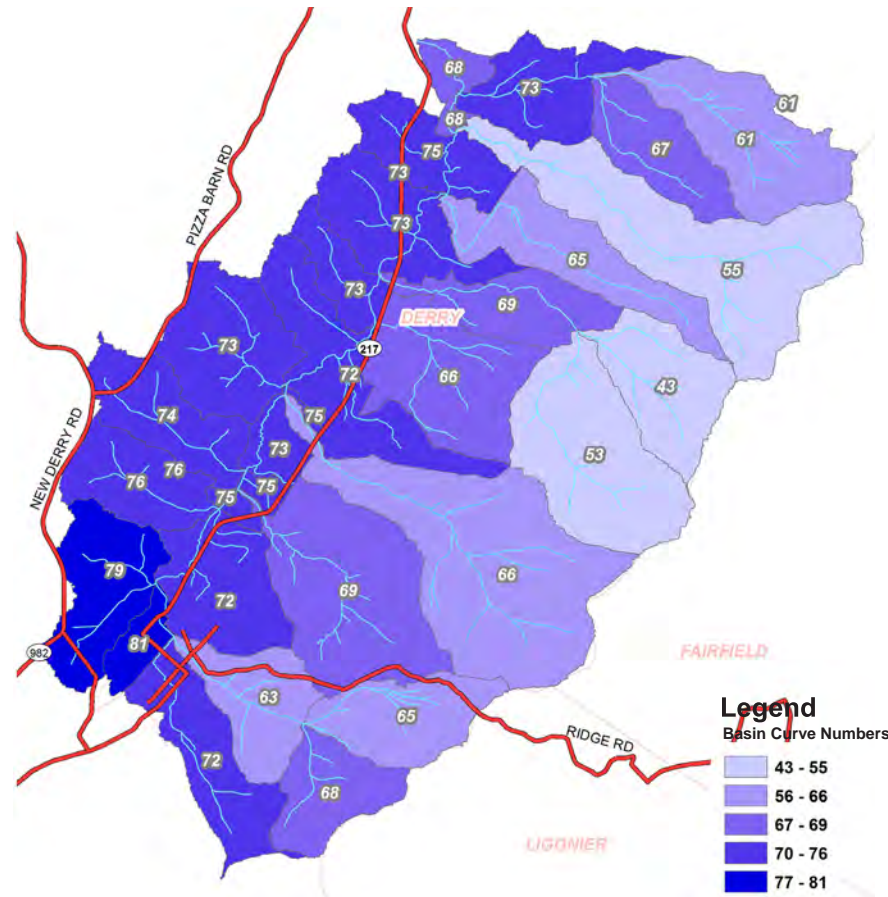
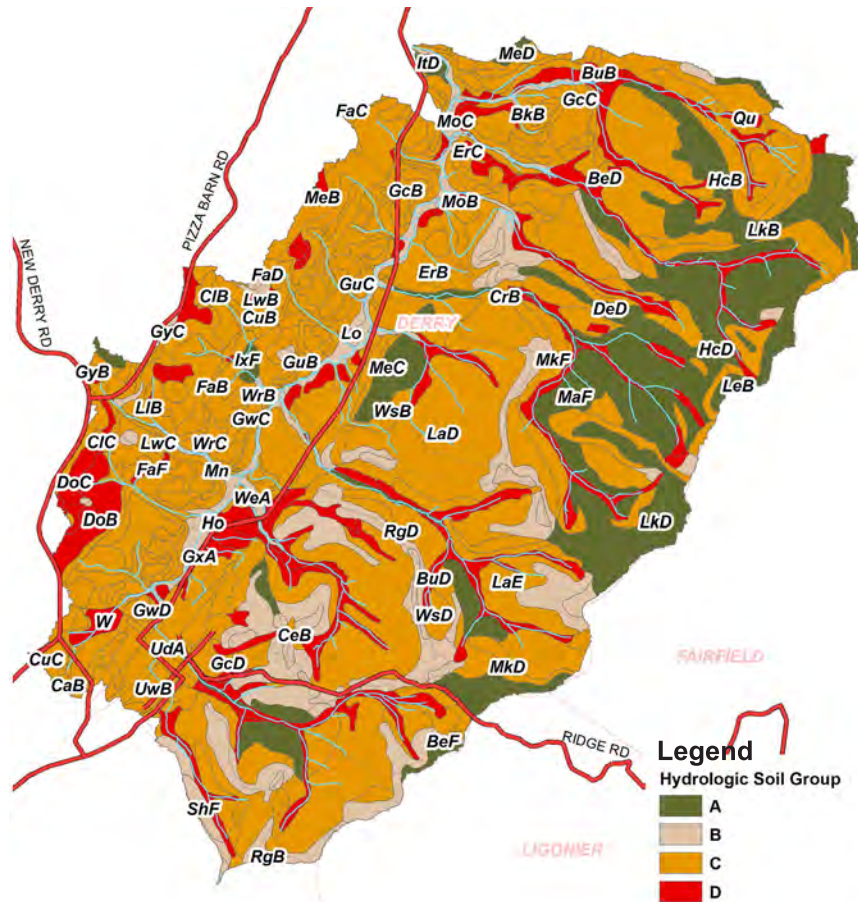



**Average Basin Slope (%) in the Conemaugh Watershed Area of Interest** Slope steepness contributes to overall runoff calculations, as steeper regions generally experience greater runoff during rain events. The ridge line that runs along the Eastern boundary of the watershed has high slopes with shallower slopes in the stream valley below. Average sub-watershed slope values range from 5.31% to 26.06%.

**The Basin Storage Ratio in the Conemaugh Watershed Area of Interest** indicates the proportion of each sub-watershed that can absorb/store water in a storm instead of directly increasing stream discharge. Storage areas include lakes, ponds and floodplains. Storage ratios range from 0 to 0.9954, therefore the storage amount available in each sub-watershed varies from 0 to 99% of the sub-watershed area.

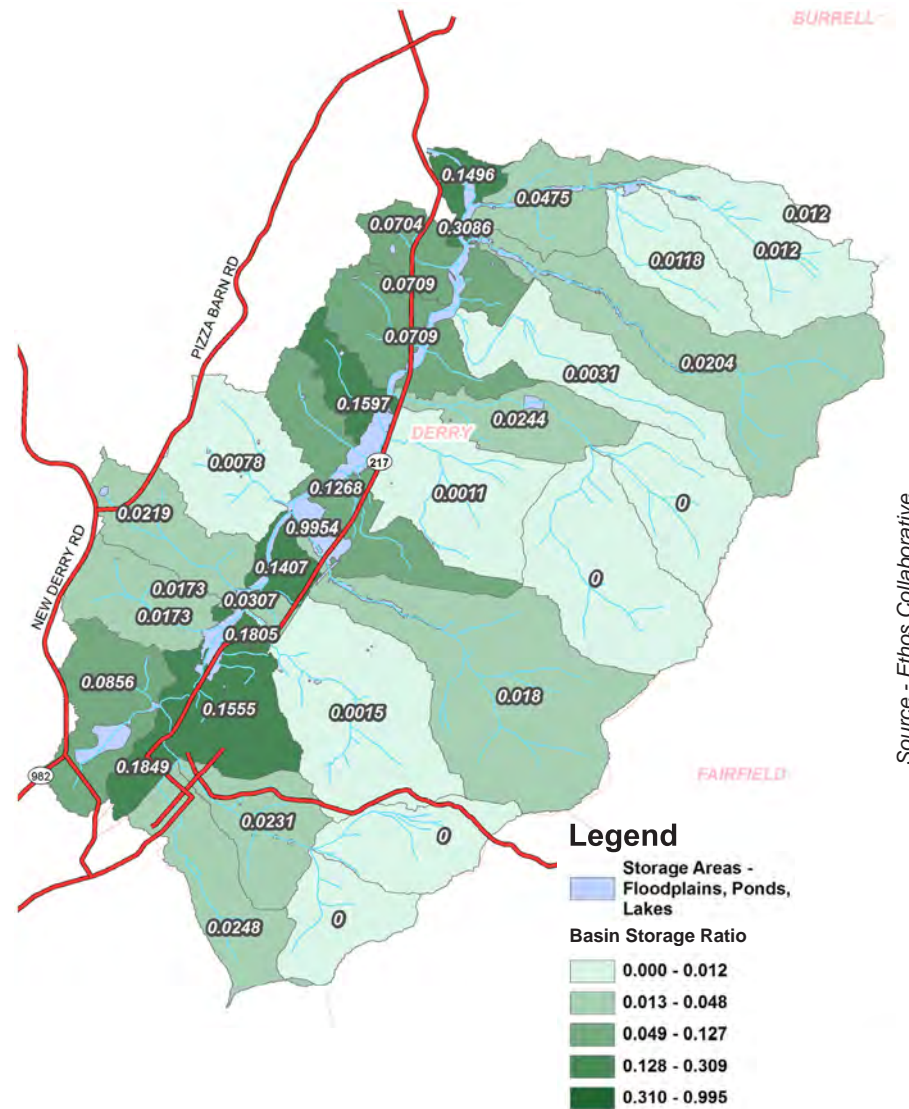
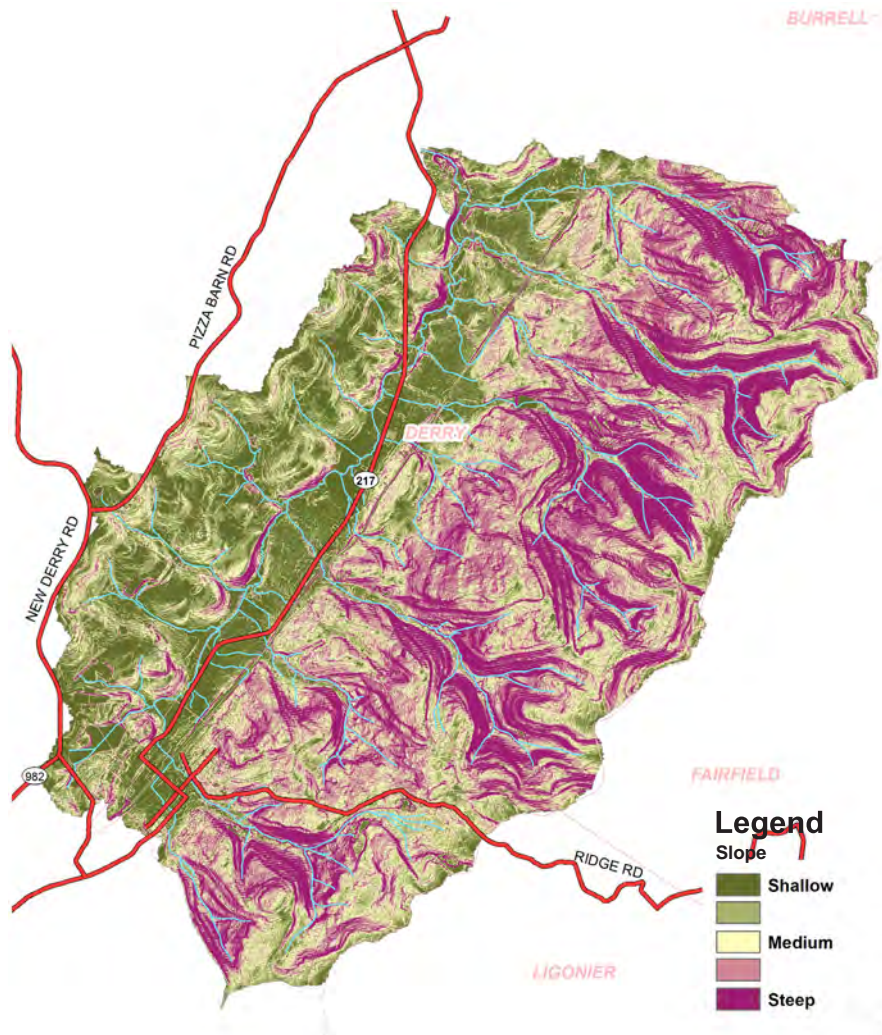

Source - Ethos Collaborative



## MODEL CALIBRATION IN THE CONEMAUGH WATERSHED AREA OF INTEREST

Five sites were chosen as “areas of interest” and model results were compared to Stream Stats data for the same site. This approach allowed us to calibrate hydrological models in the absence of multiple stream gage locations in the watershed. The graphs below show how each point of interest compares for the 2, 5, 10, 50, and 100 year storms. There is a good correlation between model results and Streams Stats data. For the methodology used for calibration, validating statistics and comparisons refer to the methodology in the appendix.

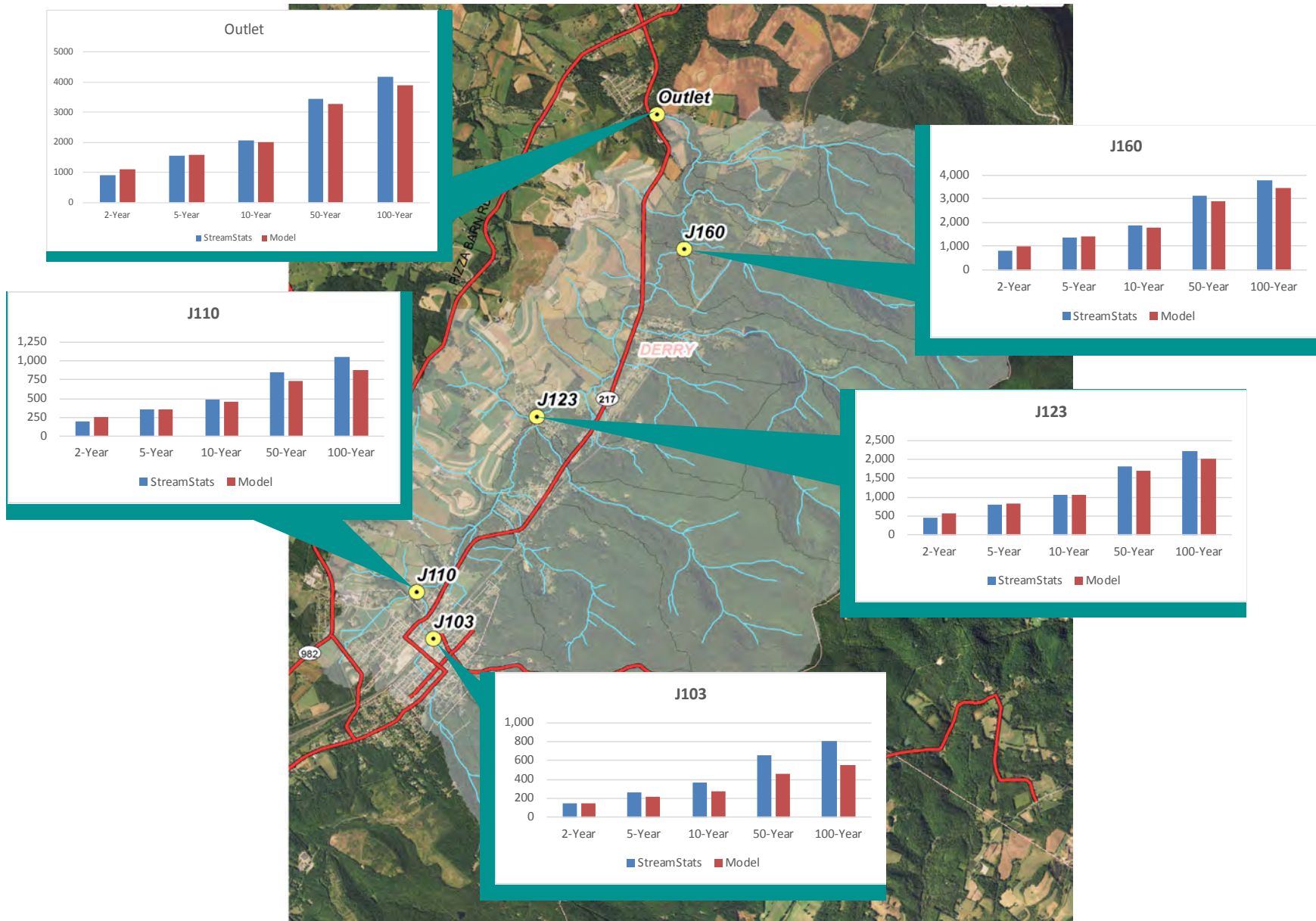

## RECOMMENDED RELEASE RATE MAP FOR THE CONEMAUGH WATERSHED AREA OF INTEREST

Release rates are a tool that help determine the timing of when water can be released from a watershed. A release rate of 50% for a sub-watershed indicates that the rate at which stormwater moves out of the watershed and downstream must be reduced by half in any future development. In contrast, a release rate of 100% indicates that, with future development, stormwater can move off of the sub-watershed at the same rate that is does in the present. In other words, lower release rates require an increased control of runoff.

Release rates were calculated based on a hydrologic model of the area of interest using HEC-HMS, the U.S. Army Corps of Engineers (USACE) Hydrologic Modeling System, in conjunction with GEO-HMS (a GIS extension that allows for the manipulation of spatial data).

Final calculated release rates show a range in value from 50-100%. Darker colors and lower release rates indicate regions where future development must reduce runoff rates.

It should be noted that the methodology to calculate release rates focuses on the basin-wide contribution of upstream land on downstream flooding. In order to control more localized flooding, individual municipalities may enact stricter stormwater runoff controls.

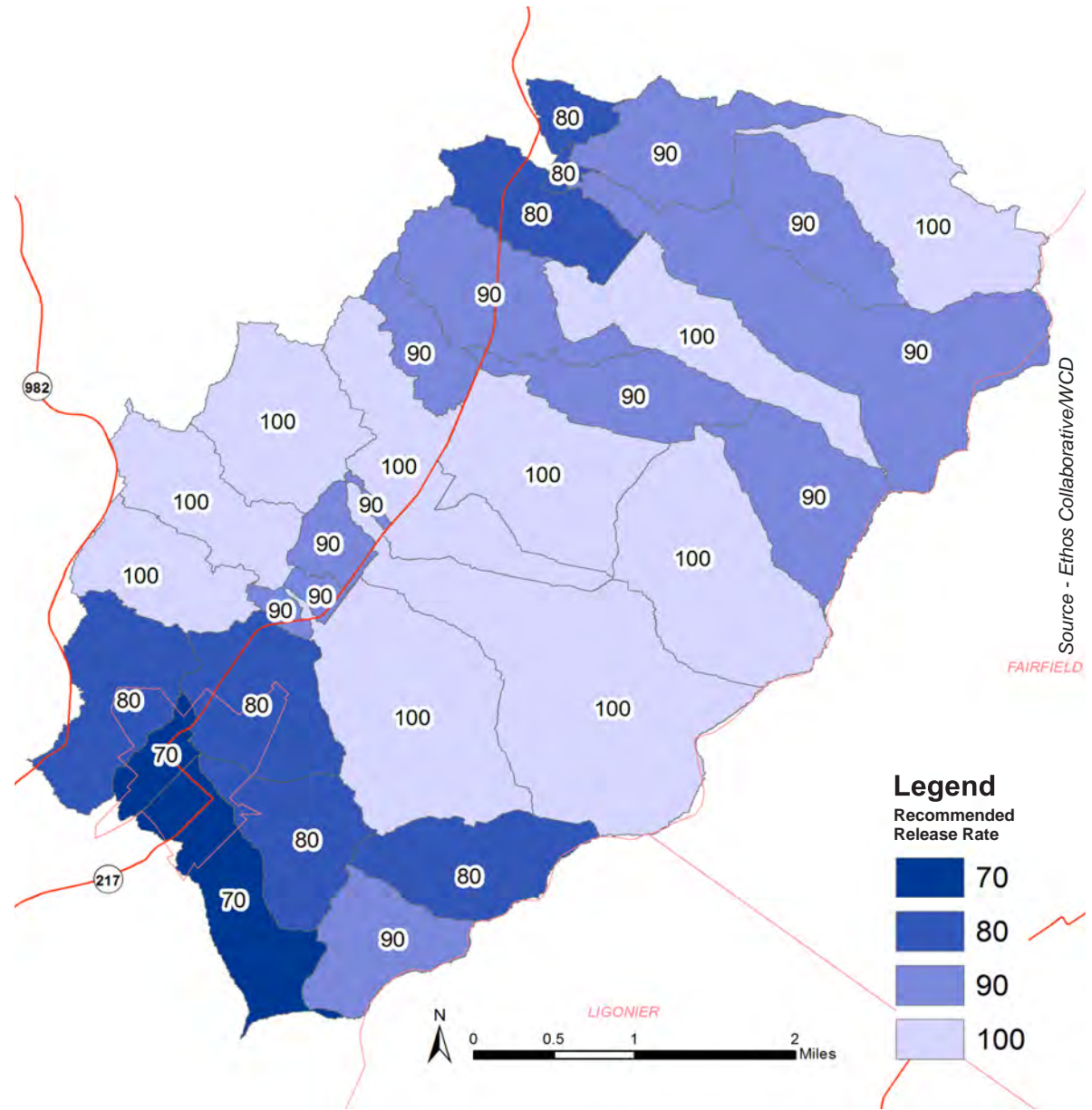



# LANDSCAPE POLLUTION ACCUMULATION MODELING

To understand where and how pollution-bearing runoff moves across the landscape, we modeled accumulation using ArcGIS in conjunction with a specialized terrain analysis toolset, (TAUDEM). This analysis allowed us to understand both pollution contributions and pollution reductions due to the underlying landscape. Please see the Methodology Appendix for further details about this process.

## TOTAL SUSPENDED SOLIDS (TSS)

Sediment, or Suspended Solids, encompasses any number of particulate pollutants or natural particles, from a myriad number of sources. Shown to the right is the estimated sub-watershed export of sediment, in pounds per year.

- Impervious surfaces in the town of Derry collect solids during dry weather and then during wet weather contribute to high TSS loads draining from these watersheds. These sub-watersheds have little in the way of riparian buffers or other landscape features that help to slow, infiltrate, and absorb water, preventing it and associated pollutant loads from moving into the stream, and subsequently downstream.
- Significant contributions of TSS are also found in sub-watersheds where agricultural activities such as grazing and plowing take place. These regions in particular would benefit from increased riparian buffers as a way to detain water and associated pollutants - and encourage infiltration - before runoff reaches the stream.

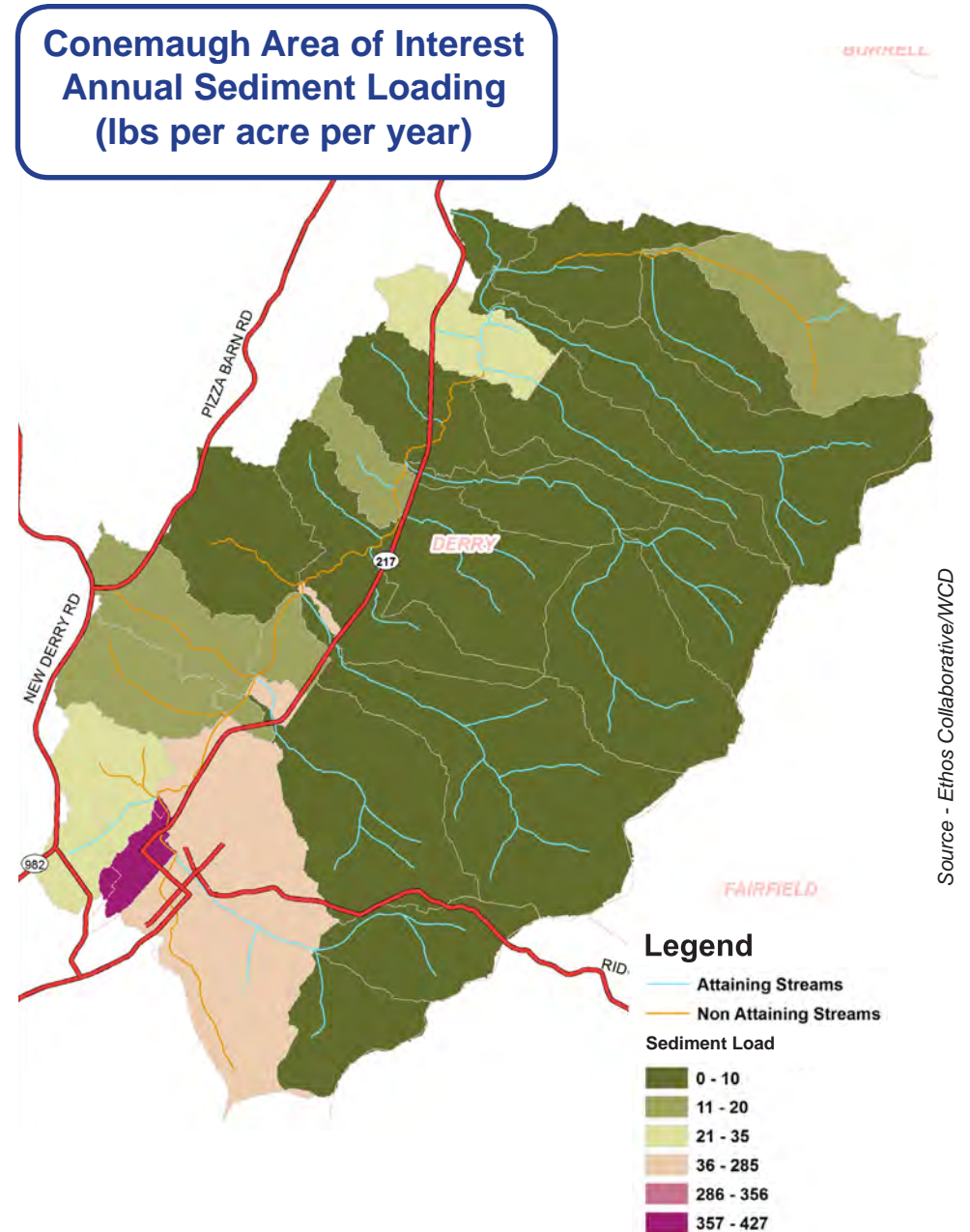

**Conemaugh Area of Interest  
Annual Nitrate Loading  
(lbs per acre per year)**

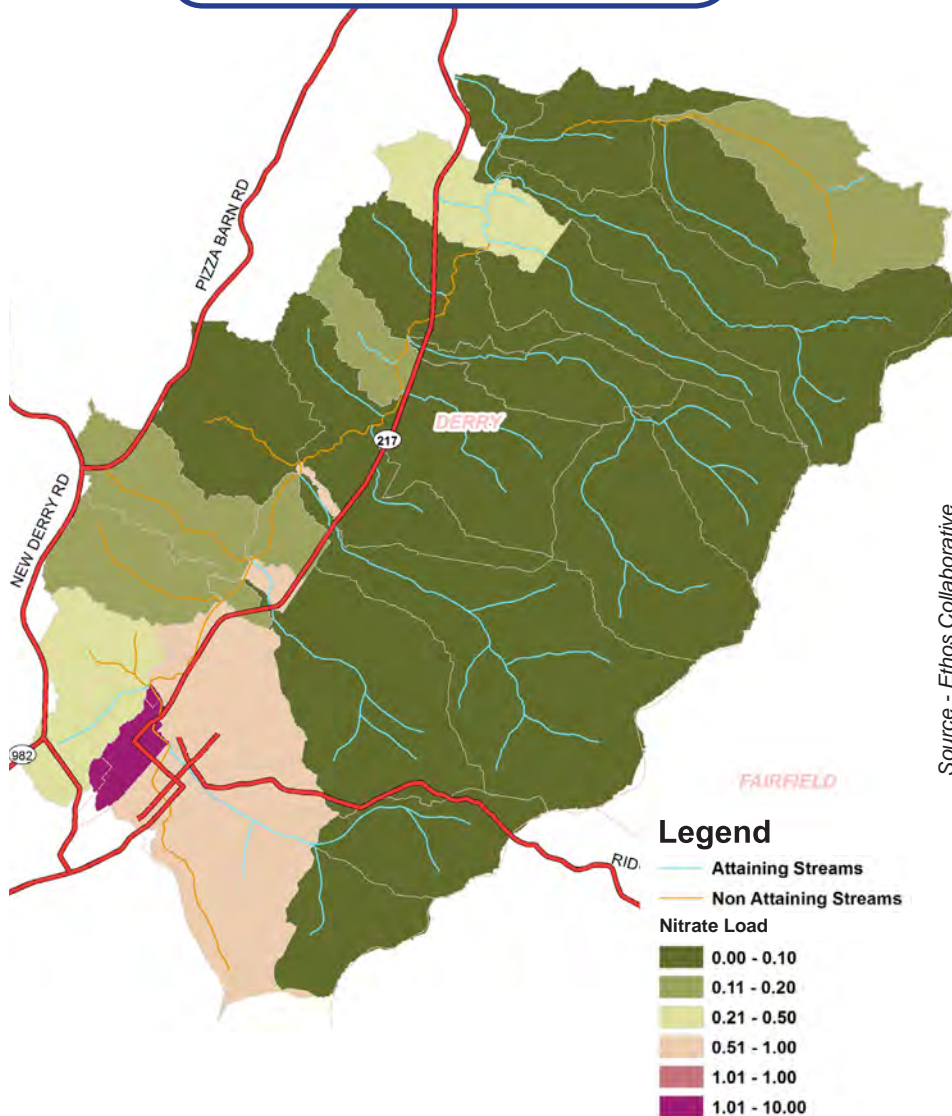

Source - Ethos Collaborative

**NITRATE (NO<sub>3</sub><sup>-</sup>)**

Nitrogen, here expressed as nitrate (NO<sub>3</sub><sup>-</sup>), is a nutrient essential for plant and animal growth. Historically, biologically available nitrogen was a limiting factor in ecosystems, however industrial activities have increased biologically available nitrogen to the point where it is now considered a pollutant in many regions. Shown on the map to the left is the modeled sub-watershed export of nitrate, in pounds per year.

- Agricultural activities and residential areas both contribute fertilizer-sourced nitrogen to the watershed. Fertilizer applied to croplands and residential lawns can be washed from the land surface into streams.
- Nitrogen can be found in urine excreted from grazing animals. Urine-sourced nitrogen is biologically transformed to nitrate, which can then be transported downstream.
- Fixed nitrogen is emitted to the atmosphere when fossil fuels are burned. This nitrogen is deposited as nitrogen oxides or NO<sub>x</sub>, on the landscape, with concentrations found in near-road areas.
- Wastewater contains biologically available nitrogen. Wastewater treatment plants may not remove all of the nitrogen before treated water is discharged to streams. On-lot septic systems may contribute biologically available nitrogen to groundwater.



## TOTAL PHOSPHORUS (TP)

Phosphorus, here expressed as Total Phosphorus (TP) is a nutrient essential for life. Phosphorus, like Nitrogen, used to be a limiting nutrient for ecosystems. Industrial activities and fertilizer both contribute excess phosphorus to ecosystems. This phosphorus contributes to algae blooms in water bodies, eutrophication, and overall habitat deterioration. Shown on the map to the right is the modeled sub-watershed export of TP in pounds per year.

- Higher amounts of phosphorus are exported from the urban sub-watersheds in the Conemaugh AOI. Phosphorus is sourced primarily from lawn fertilizer and roadway deposition. These sources produce both particulate and dissolved forms of phosphorus.
- Soil erosion is another contributor of phosphorus to streamwater. Erosion depletes the soil of valuable nutrients like phosphorus and transports the nutrient downstream,.
- Crops lands export Phosphorus to downstream environs, sourced from fertilizer applied to the fields. Fertilizer-sourced Phosphorus is likely in particulate forms, and therefore structural BMP's that filter and/or detain sediment and particles can help to mitigate downstream export.
- Wastewater contains phosphorus from human waste and detergents. Wastewater treatment plants may not remove all of the phosphorus before treated water is discharged to streams.

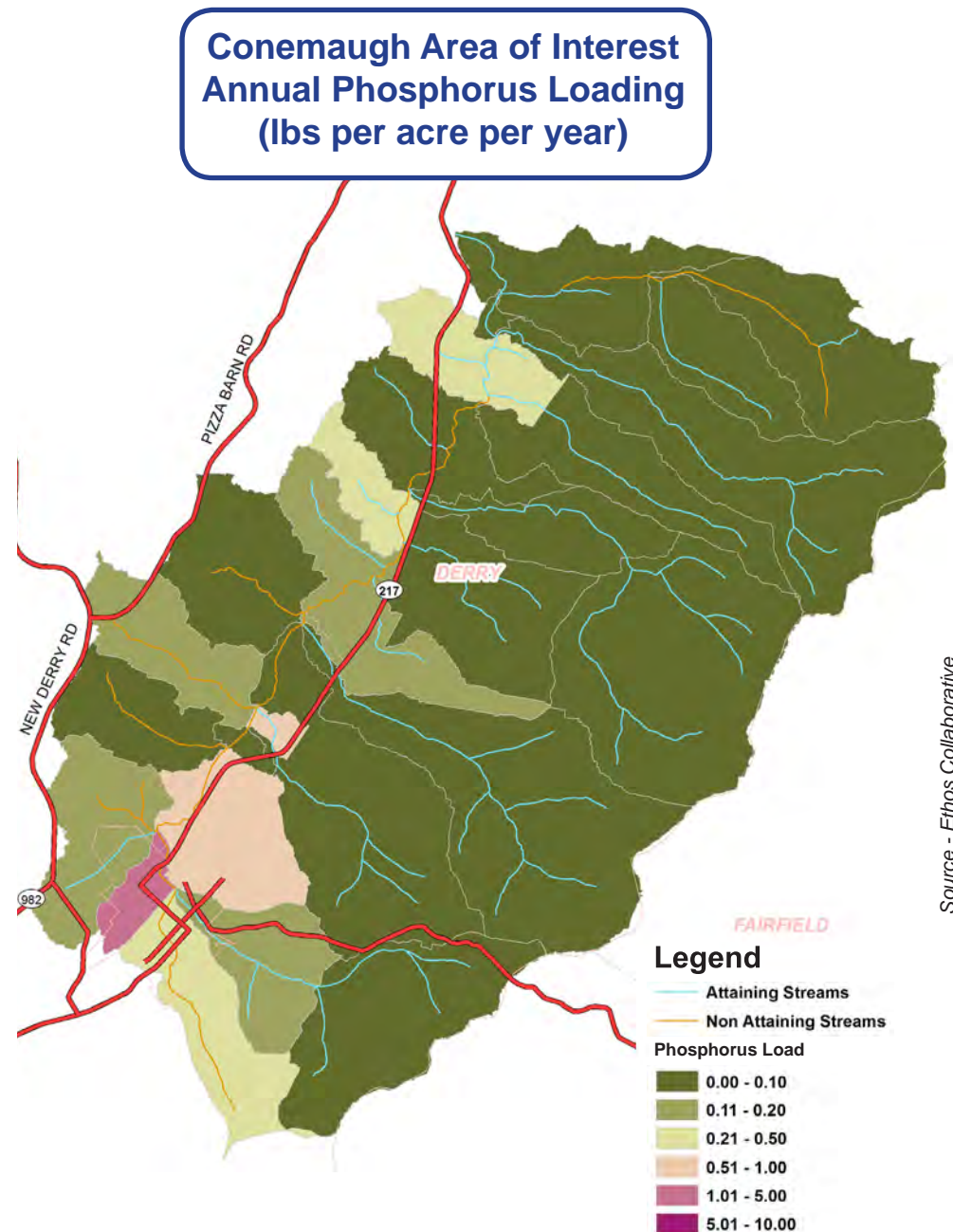

# OPPORTUNITIES FOR EFFECTIVE STORMWATER MANAGERMENTS

Based on modeling watershed hydrology and pollution sources to inform smart water management

## Effective water management protects valuable resources and built infrastructure.

Water and the soil used in agricultural lands in this watershed are both valuable resources that must be conserved for future generations. Conservation efforts should consider ways to manage water runoff that decrease soil erosion, pollution transport, and sedimentation in the reservoir.

## To increase water quality, we must decrease overland water quantity.

Water detained by increasing infiltration to groundwater encourages nutrient retention, or the uptake and filtration of pollutants by biota and soil. Together, the processes of detention and retention increase water quality through decreasing erosion and downstream transport.

## Conceptual Ideas for BMP's/Landscape Restoration: Highlighting the potential for water and pollutant capture and retention.

Specific identified issues in this area of interest include a lack of sufficient riparian buffer along the stream in agricultural sub-watersheds and through the town of Derry. The lack of riparian buffer along the stream adds to stormwater runoff and associated erosion. Landscape-based nutrient accumulation and decay modeling and other spatial analysis can help to identify and prioritize project sites appropriate for Green Infrastructure such as stormwater retrofits, riparian buffer restoration, and stream restoration.

## Opportunities for Effective Stormwater management

On this map, stream-side regions with little or no riparian buffers are highlighted. Focusing on restoring tree canopy in these areas would help to mitigate stream nutrient and sediment loading. Additionally, two regions in the town of Derry with known stormwater or water quality issues are identified.

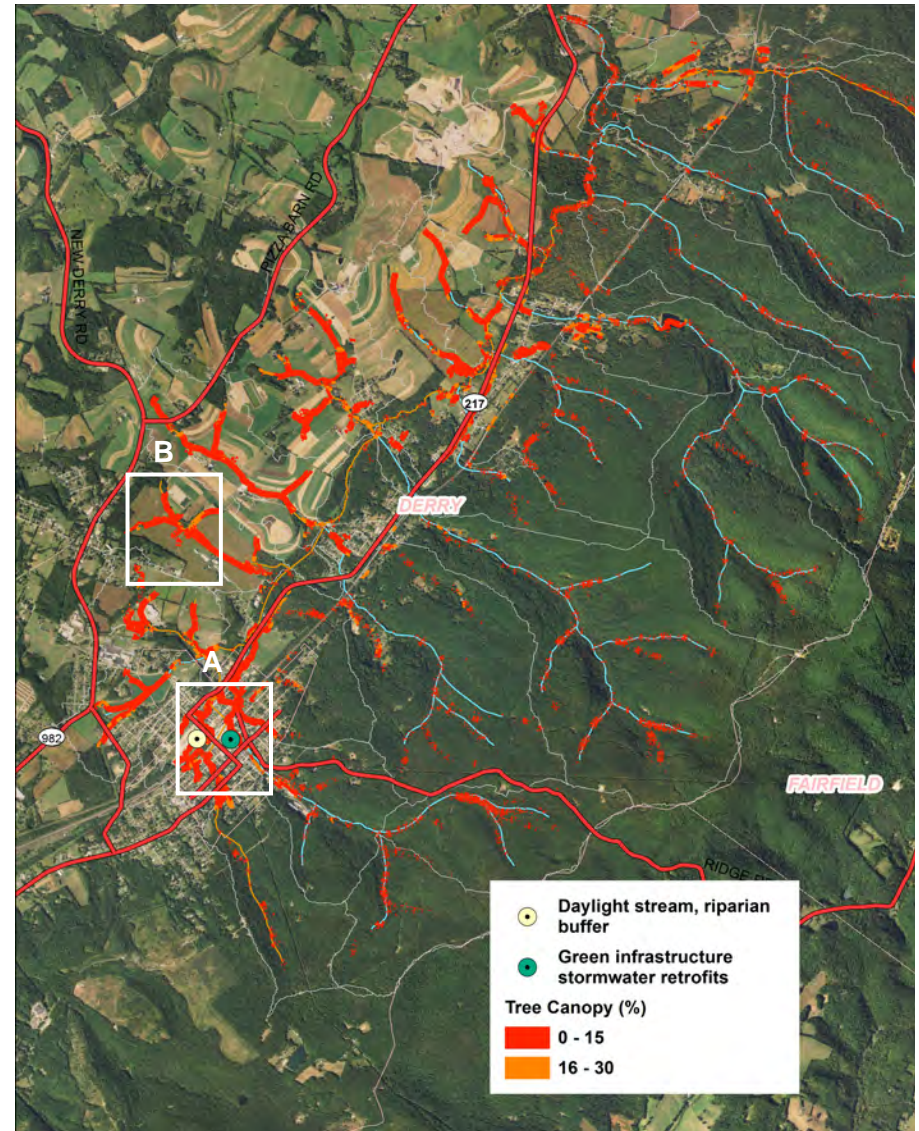

See enlarged images.





A: Enlargement of urban area in Derry Borough, Conemaugh Area of Interest, showing opportunities

**Opportunity: Retrofits and restoration in Derry**

Above, a close up map shows the *approximate* region of identified problem areas, as well as the *approximate* stream location. The stream through Derry is largely routed through underground storm sewer networks. Also shown are the surface flow paths that indicate increasing sediment accumulation across the land surfaces.

**Stormwater Management Potential:**

Restoring the stream banks and retrofitting infrastructure in this area to include Green Infrastructure would help to decrease flooding and pollution inputs delivered to the stream in storm runoff.

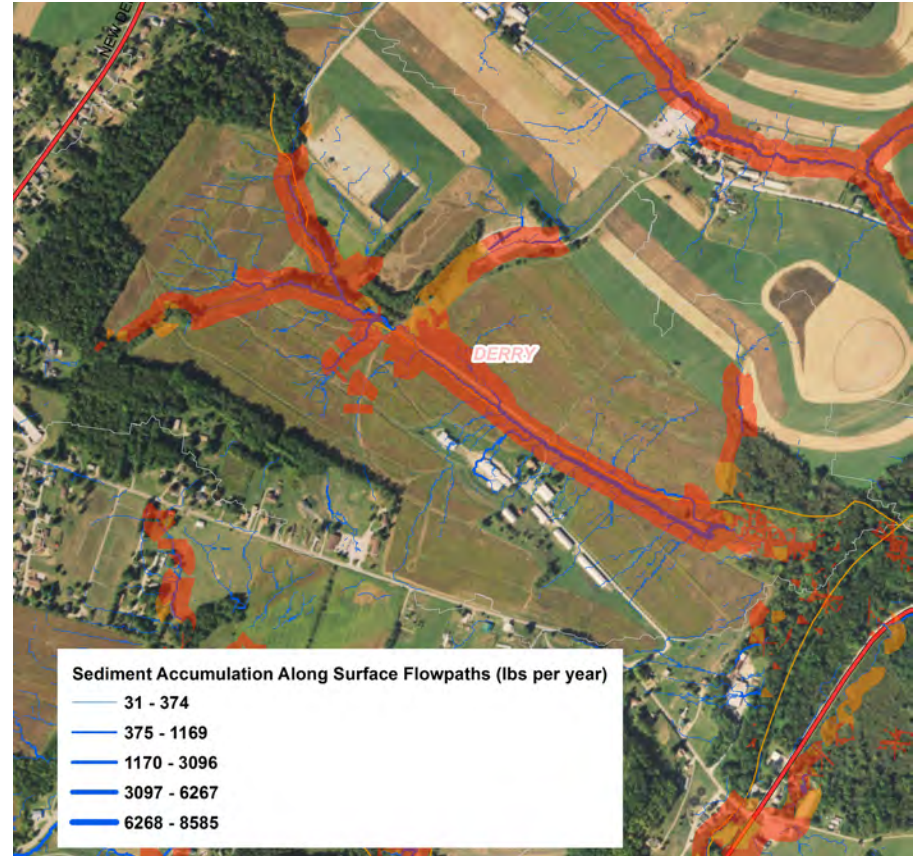

B: Enlargement of rural area in Derry Township, Conemaugh Area of Interest, showing opportunities

**Landscape Elements to Consider:**

The map above shows a close-up view of a watershed in the Northeast of the Conemaugh Watershed. As indicated by the red and orange buffers on either side of the stream, there is little tree canopy in the riparian buffer.

**Water Quality Impacts of Stormwater Management:**

Augmenting the riparian buffer in these areas would help improve water quality. Increased tree canopy would slow overland flow from agricultural land, encouraging water and particle infiltration/settling and increasing biological processing interactions. This would help to decrease stream loads of TSS, TP and TNO3- that are contributed from the landscape.



# LOYALHANNA CREEK WATERSHED AREA OF INTEREST

## REGION OVERVIEW

The Loyalhanna Creek Area of Interest is approximately 230 mi<sup>2</sup>/147,200 acres and contains ~750 miles of streams. The headwaters of the Loyalhanna Creek start on the Laurel Ridge. From here, the stream drops down and flows through a steeply sloping ravine that bisects Chestnut Ridge. The Loyalhanna Creek drains north into the Kiski river just outside of Saltsburg, PA. This is the largest Area of Interest examined as part of the IWRP process. In this area, one hundred and thirty four sub-watersheds were delineated ranging from a few acres to 6 square miles in size. Most sub-watersheds were in the range of 1-2 square miles.

### Why is this watershed of particular interest?

This watershed was identified in Phase I as an area of interest because of re-occurring flood problems, inadequate infrastructure, and the potential for growth. The largely rural landscape leaves room for future expansion of residential or industrial areas. There is tremendous opportunity to carefully manage future development and stormwater planning in this area, to conserve and preserve the current water quality.

### Assets in the Watershed

The lovely landscape and outdoor amenities draw visitors and residents alike. The streams in this area are largely considered “attaining” for recreational, potable water supply, and aquatic life uses. Trout fishing in the Loyalhanna creek is a popular pastime. There is an active Loyalhanna Watershed Association dedicated to increasing water quality, conserving and preserving land, and offering educational programs and nature-based experiences to school groups and families. [www.loyalhannawatershed.org](http://www.loyalhannawatershed.org)

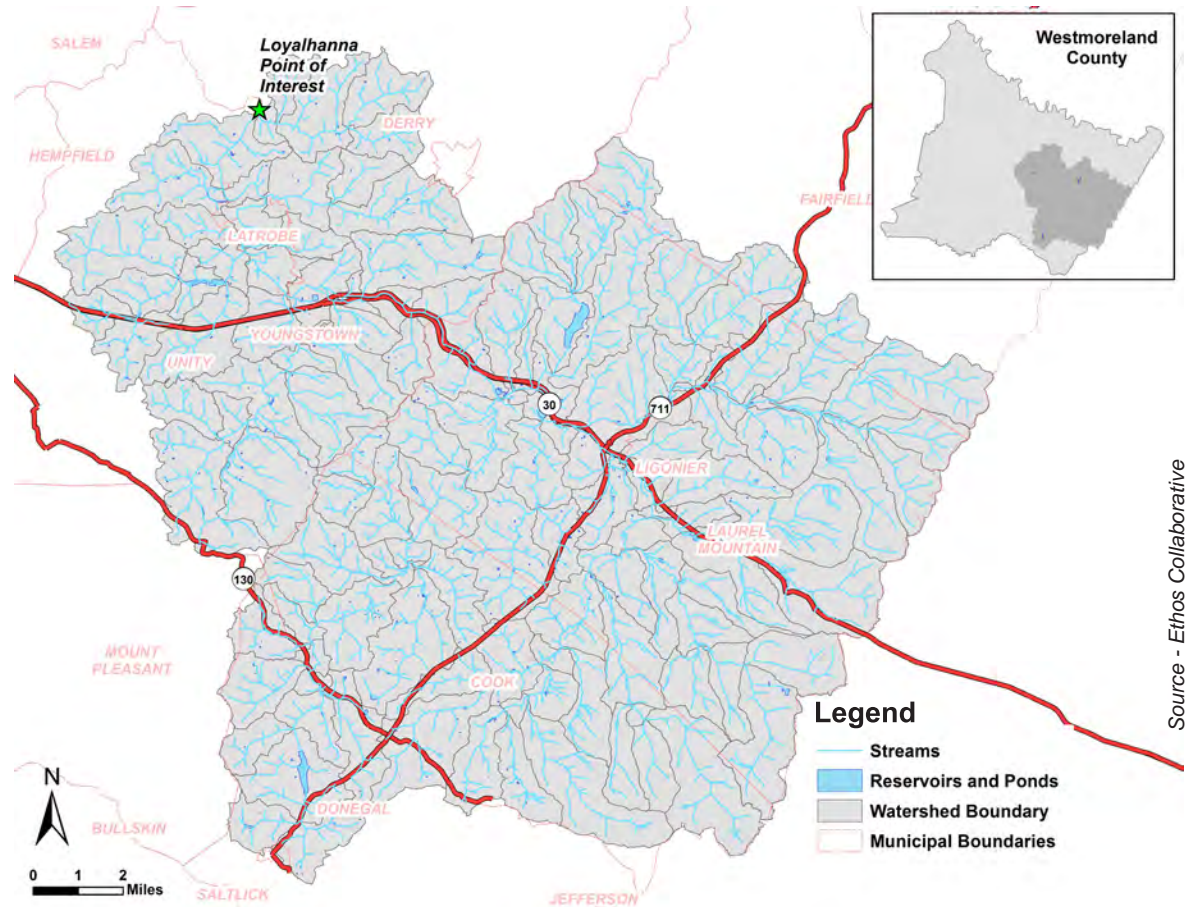

Source - Ethos Collaborative

## WATERSHED SNAPSHOT

- **Area:** 230 square miles
- **Water Quality:** Some areas are impaired for aquatic life.
- **Characterization:** This area of interest is largely forested, with pockets of developed land.
- **Highways** provide relatively quick transportation from this rural region to the cities of Pittsburgh and Greensburg. These qualities make the region an ideal location for future development.



## Landcover / Landuse

Landcover in this watershed is dominated by deciduous forest and hay/pasture, with a concentration of urbanized land and associated impervious surface around the town of Latrobe, and along State Route 30 / the historic Lincoln Highway. Landcover data is based on the 2011 National Land Cover Dataset, created by the Multi-resolution Land Characteristics Consortium (MRLC). Refer to [www.mrlc.gov](http://www.mrlc.gov) for methodology.

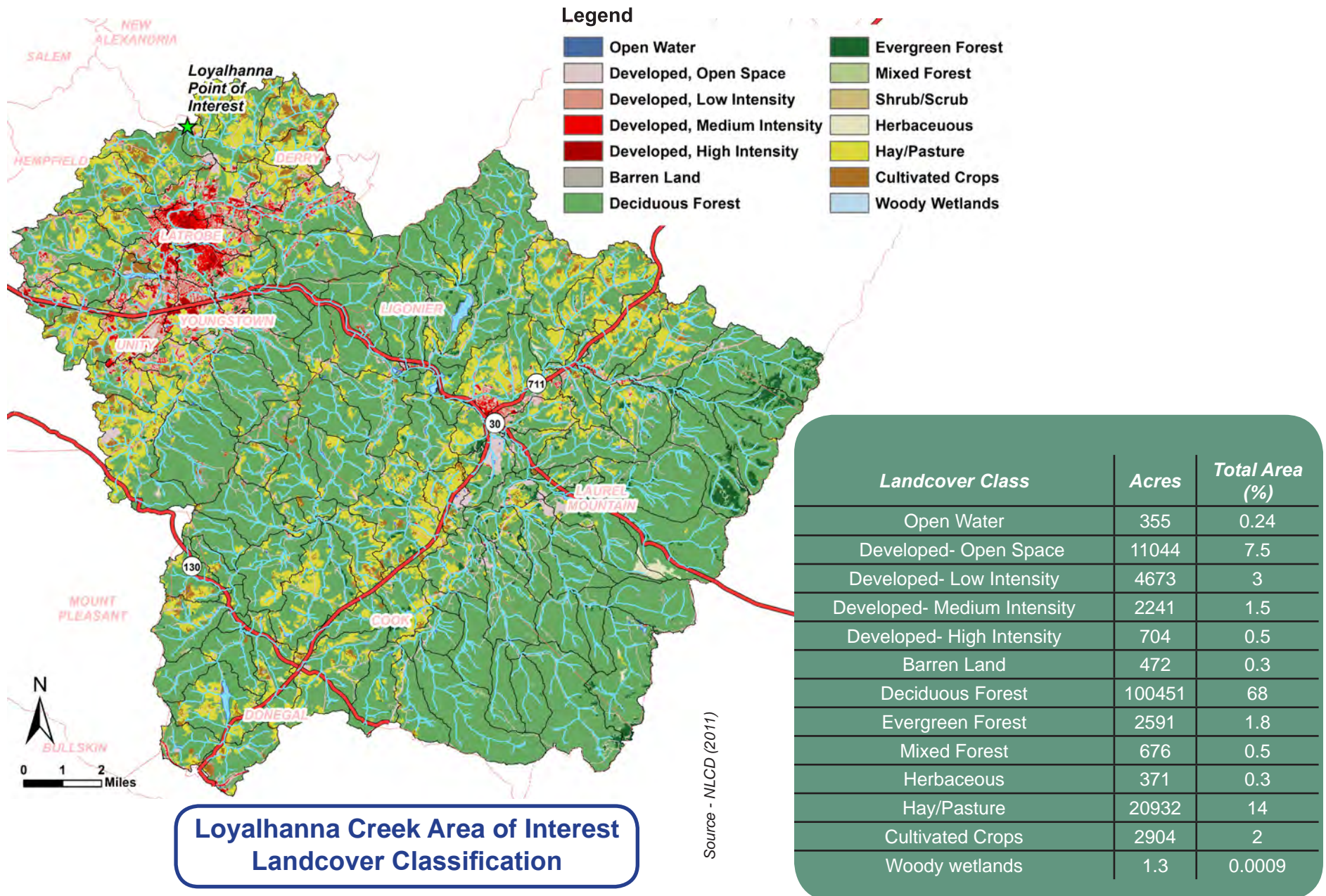



## CURRENT WATER QUALITY IN THE LOYALHANNA CREEK WATERSHED AREA OF INTEREST

### Non-point source pollution

In the Loyalhanna Watershed AOI, the Pennsylvania Department of Environmental Protection identified 675 stream miles as “attaining” their designated uses of providing a potable water supply, supporting aquatic life, and recreation. Only 60.5 miles are considered “non-attaining” for those specific designated uses, and the remaining are unclassified. Identified impairments include siltation from abandoned mine drainage, nutrients from agricultural land, as well as runoff and nutrients from residential/urban areas within the watershed. These are considered non-point sources, originating not from one identifiable point but instead from diffuse sources across the landscape.

### Loyalhanna Watershed Area of Interest Attaining & Impaired Streams

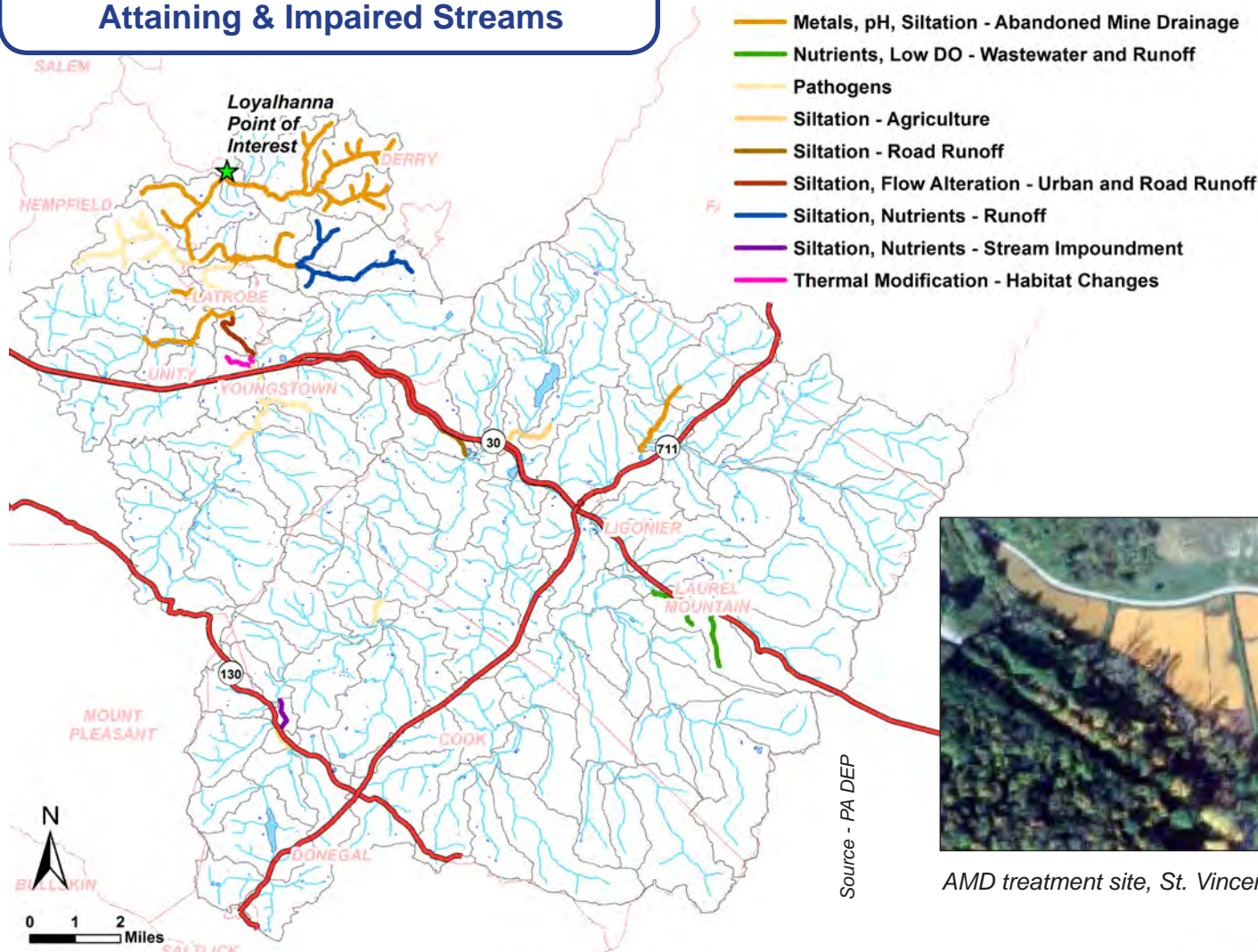

### TMDL status of the streams in this area of interest

Despite the “attaining” status of so many stream miles in the Area of Interest, 531 miles are under one of 4 TMDL (Total Maximum Daily Load) agreements. Each of these agreements seeks to reduce the affect of Abandoned Mine Drainage, including metals, pH, and siltation, on the water. The other impairment sources are not addressed by TMDL agreements.



AMD treatment site, St. Vincent's Archabbey, Latrobe, PA

Image from Google Maps



## WATER QUALITY AND QUANTITY ARE INEXTRICABLY LINKED IN THE LOYALHANNA WATERSHED AREA OF INTEREST

As water accumulates and moves overland on impervious surfaces, it picks up pollutants from the surface of the landscape and delivers it to receiving waters. Development, particularly that which increases impervious surfaces on the landscape, increases the overland flow of water during storms and decreases infiltration to groundwater. Increased stormwater also increases the erosive force of overland flow, increasing sediment load and delivering it to downstream receiving waters. Below, a watershed map shows the concentration of impervious surface in the towns of Latrobe, Youngstown, and Ligonier.

As stormwater runoff increases, so does the water's capacity to carry sediment and nutrients such as Nitrogen and Phosphorus. Stormwater may drop sediment and pollutants when the flow/energy of the water decreases.

Both the sediment and the pollution are a threat to water. Accumulated nutrients can lead to harmful algae blooms, which may affect wildlife and water quality, particularly for species of interest such as trout or salamanders. The sediment accumulation represents the erosion, and loss, of valuable soil from upstream farming landscapes.



Loyalhanna Creek, summer

Photo by Stephen Simpson

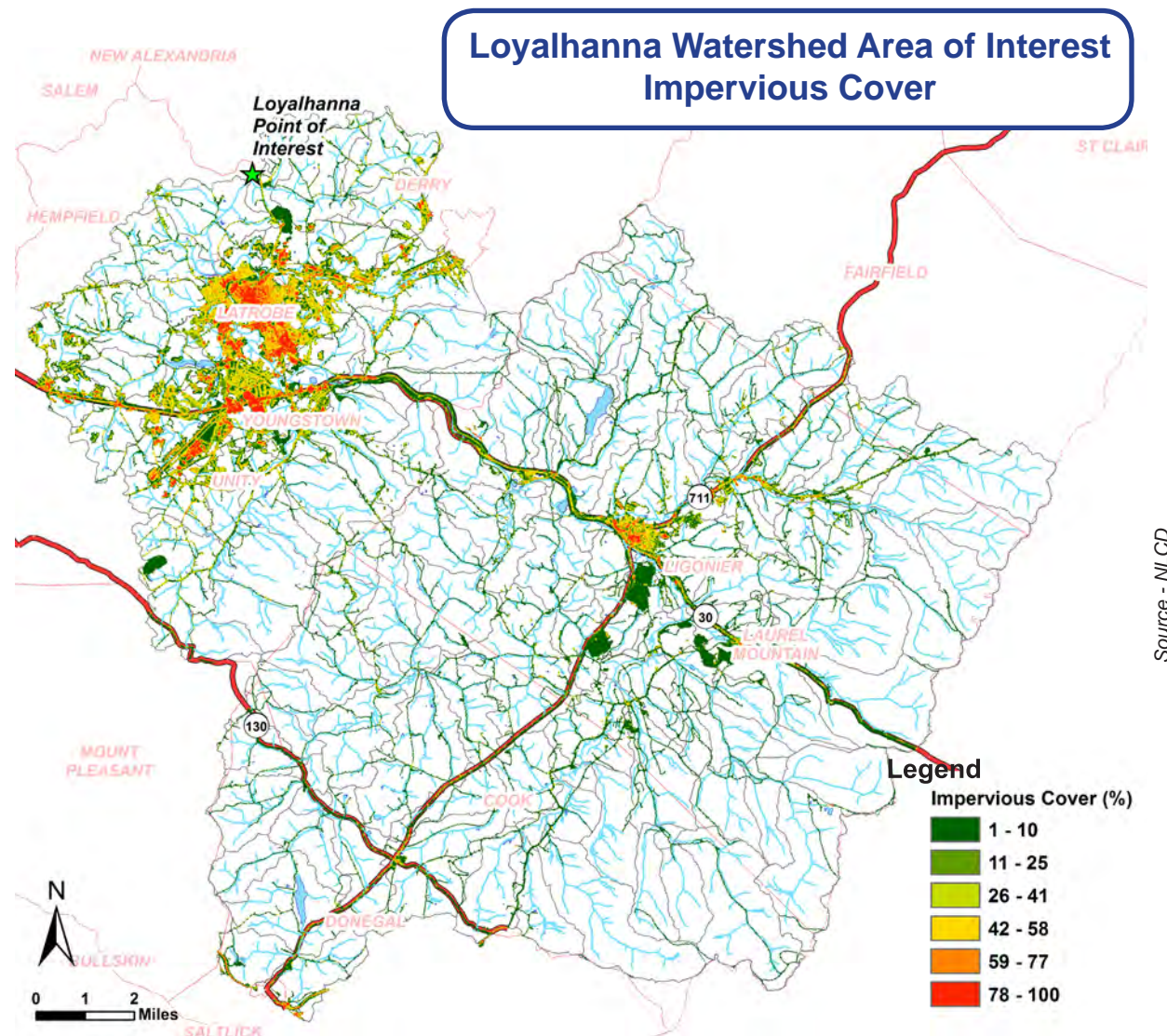



## FUTURE TRENDS IN THE LOYALHANNA WATERSHED AREA OF INTEREST

There is tremendous opportunity to manage future growth in this watershed carefully. Future land-use predictions indicate there

may be very limited increases in development and accompanying stormwater flow in the Loyalhanna Area of interest. The projections below are compiled from the ESRI GREEN INFRASTRUCTURE Online Mapping tool, developed in conjunction with the Clark Labs (<http://www.esri.com/about-esri/greeninfrastructure>).

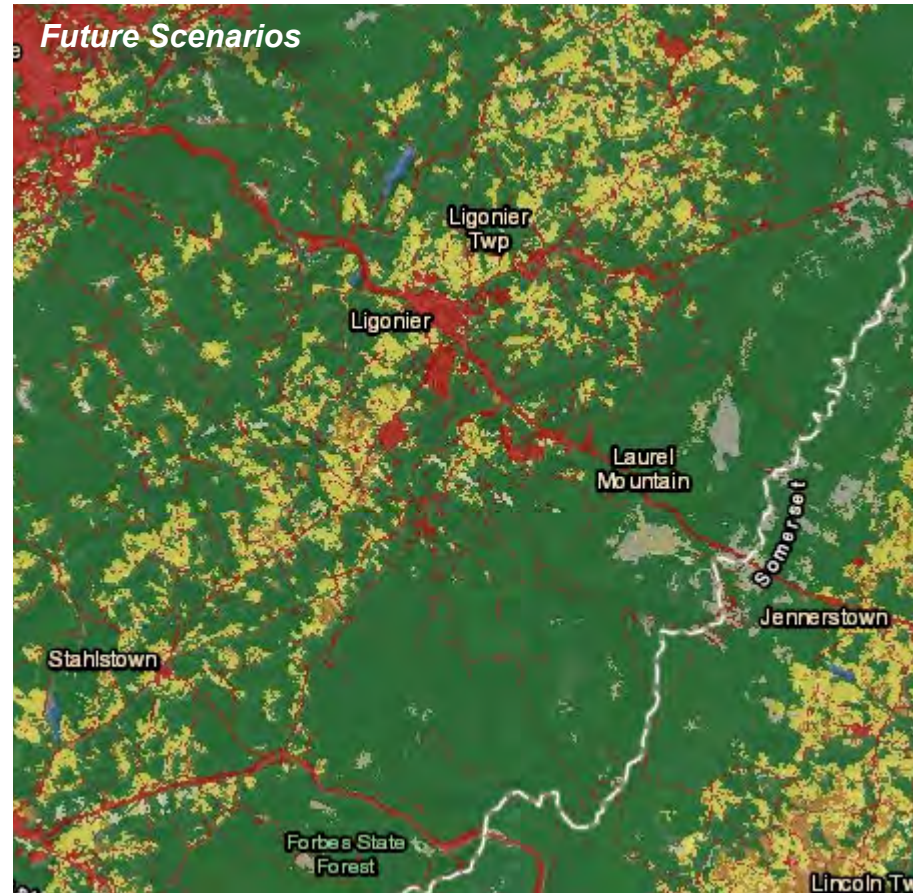
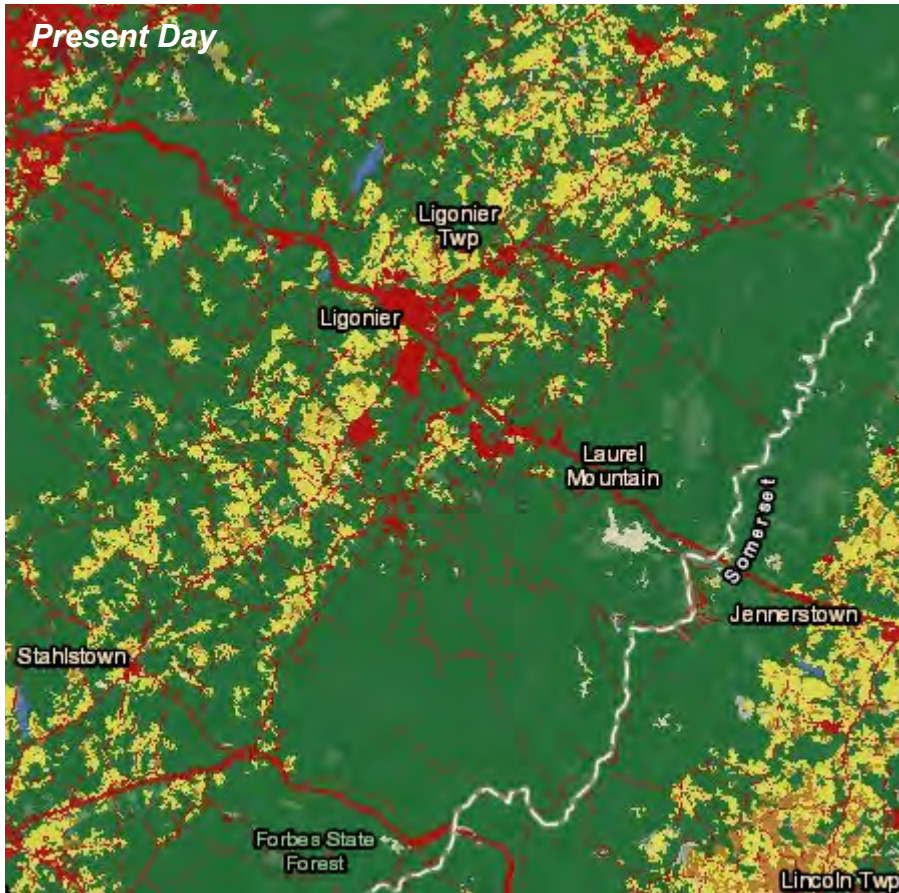

### Legend

National Land Cover Database

	Open Water		Grassland/Herbaceous
	Perennial Ice/Snow		Pasture/Hay
	Developed		Cultivated Crops
	Barren Land (Rock/Sand/Clay)		Herbaceous and Woody Wetlands
	Forests		
	Scrub/Shrub		

### Specific predictions of change in land-use

Above, a visual comparison of land use in 2011 versus predicted land use in 2050 highlights that little development is predicted for this watershed. This analysis of land use change in the Loyalhanna Area of Interest specifically estimates

- A 3% *INCREASE* in developed land,
- A 3% *DECREASE* in forest cover
- A 0.8% *DECREASE* in agricultural cropland.

Source - ESRI



## HYDROLOGIC WATERSHED MODELING

Controlling water now and in the future requires an understanding of current watershed conditions and pollution sources. The hydrologic watershed modeling has yet to be completed on this entire watershed. The **Parameters** below and on the following pages will be used to help us understand the contribution of different sub-watersheds to the flow of the whole.

**Hydrologic Soil Groups in the Loyalhanna Watershed Area of Interest.** The map below is color-coded by the Hydrologic Soil Group, which indicates a soil's water holding capacity. Group A soils have low runoff potential and high infiltration rates, while Group D soils show the highest runoff potential with very low infiltration rates. Also shown are the specific soil names, please see appendix for a list and descriptions of individual soil types.

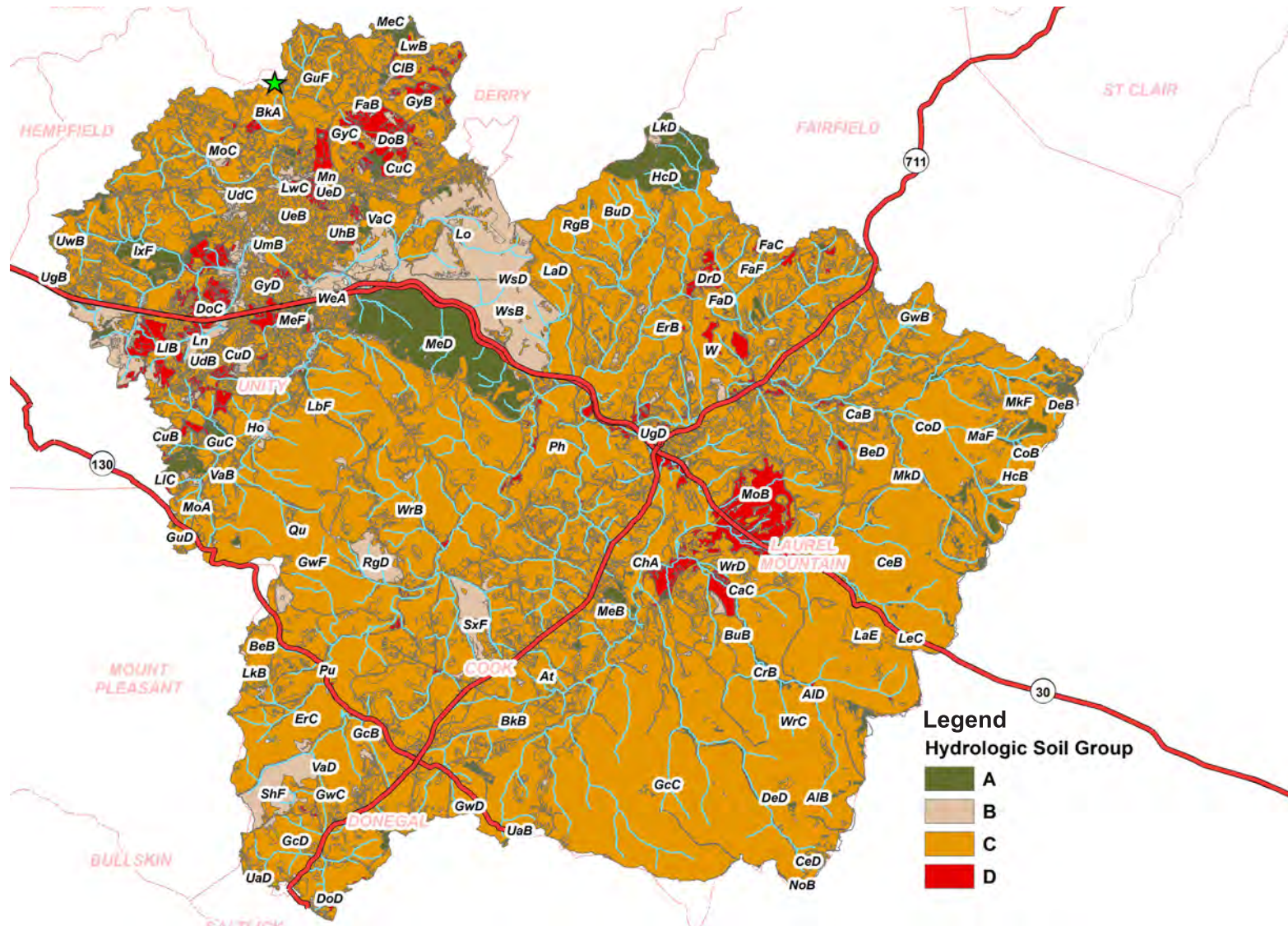

Source - PASDA

**Basin Curve Numbers (“CN’s”) in the Loyalhanna Watershed Area of Interest** are an empirical parameter that helps to predict direct runoff/infiltration from a parcel of land during a rain event. In the Loyalhanna area of interest, CN’s averaged across the watershed show a range from ~31-83. The low CN’s are indicative of watersheds where there is little runoff during a rain event, for example a forested region with soils that exhibit high infiltration rates.

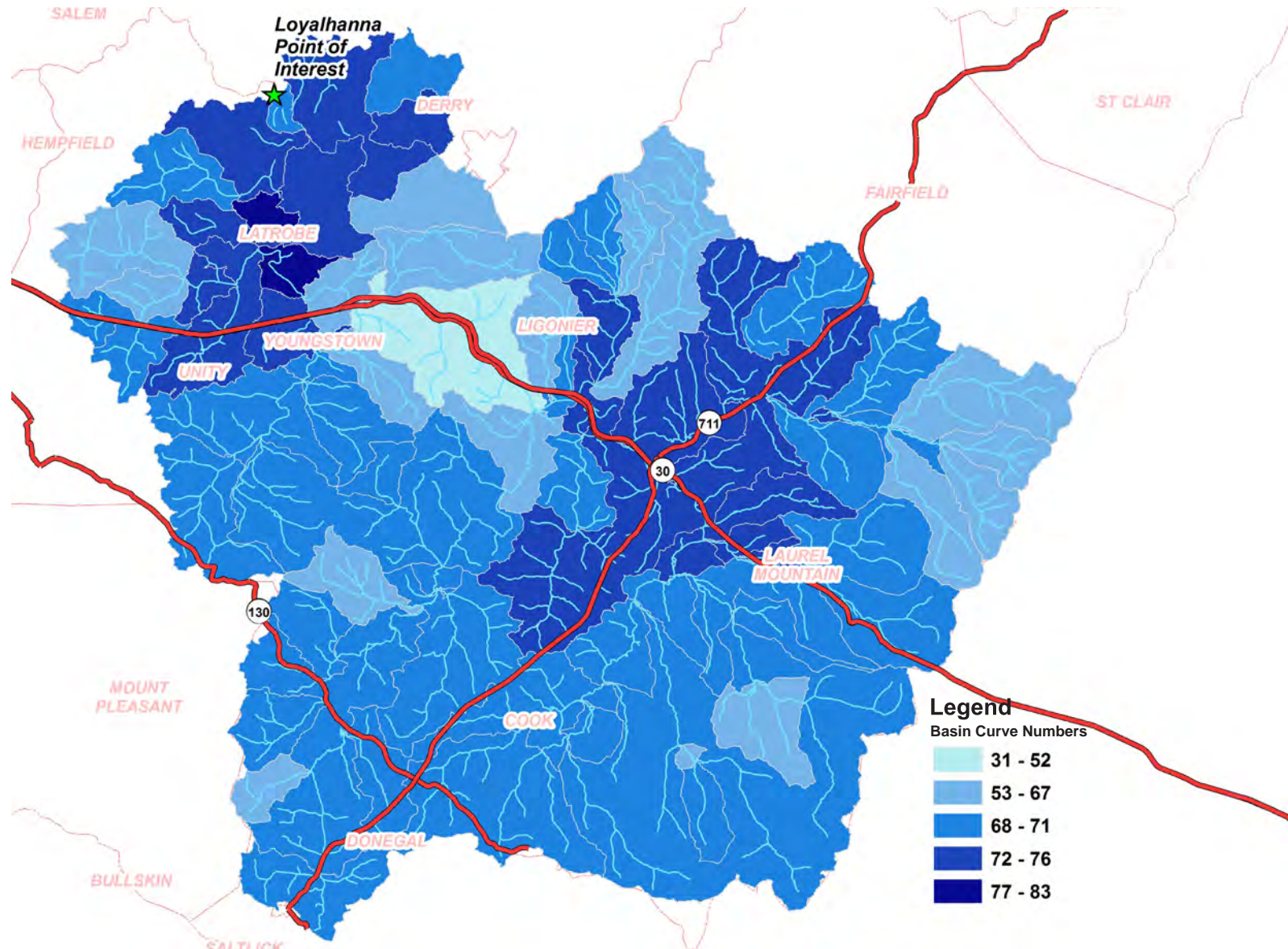

Source - Ethos Collaborative



**Average Basin Slope (%) in the Loyalhanna Watershed Area of Interest** Generally most regions in this watershed have shallow to moderate slopes. Steeper slopes are found as the stream valleys move from the Laurel and Chestnut Ridges, and plunge to the valleys below. Slope steepness contributes to overall runoff calculations, as steeper regions generally experience greater runoff during rain events.



Source - Ethos Collaborative



## LANDSCAPE POLLUTION AND ACCUMULATION MODELING

To understand where and how pollution-bearing runoff moves across the landscape, we modeled accumulation using ArcGIS in conjunction with a specialized terrain analysis toolset, (TAUDEM). This analysis allowed us to understand both pollution contributions and pollution reductions due to the underlying landscape. Please see the Methodology Appendix for further details about this process.

### TOTAL SUSPENDED SOLIDS (TSS)

Sediment, or Suspended Solids, encompasses any number of particulate pollutants or natural particles, from a myriad number of sources. Shown is the estimated sub-watershed export of sediment, in pounds per year.

- The high percent of impervious surfaces associated with the highways and urban centers of Latrobe, Ligonier, and Youngstown, and Unity collect solids during dry weather and then during wet weather contribute to high TSS loads. Urbanized areas have little in the way of riparian buffers or other landscape features that help to slow, infiltrate, and absorb water, preventing it and associated pollutant loads from moving into the stream, and subsequently downstream.
- Significant contributions of TSS are also found in sub-watersheds where agricultural activities such as grazing and plowing take place. These regions in particular would benefit from the increase in riparian buffers as a way to capture water and associated pollutants before it reaches the stream.

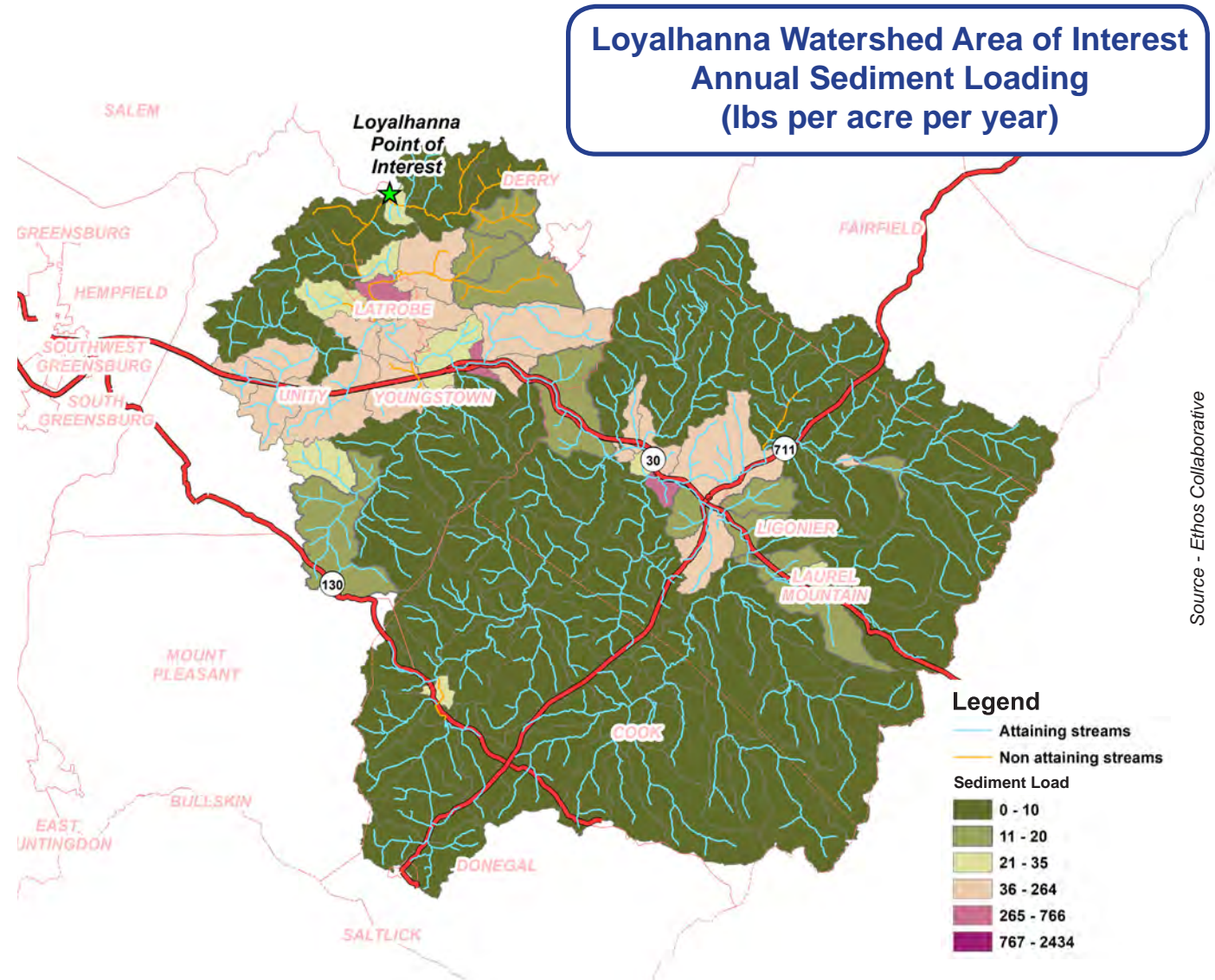

Source - Ethos Collaborative



## NITRATE (TNO3<sup>-</sup>)

Nitrogen, here expressed as nitrate (NO<sub>3</sub><sup>-</sup>), is a nutrient essential for plant and animal growth. Historically, biologically available nitrogen was a limiting factor in ecosystems, however industrial activities have increased biologically available nitrogen to the point where it is now considered a pollutant in many regions. Shown on the map is the modeled sub-watershed export of nitrate, in pounds per year.

- Agricultural activities and residential areas both contribute fertilizer-sourced nitrogen to the watershed. Fertilizer applied to croplands and residential lawns can be washed from the land surface into streams.
- Nitrogen can be found in urine excreted from grazing animals. Urine-sourced nitrogen is biologically transformed to nitrate, which can then be transported downstream.
- Fixed nitrogen is emitted to the atmosphere when fossil fuels are burned. This nitrogen is deposited as nitrogen oxides or NO<sub>x</sub>, on the landscape, with concentrations found in near-road areas.
- Wastewater contains biologically available nitrogen. Wastewater treatment plants may not remove all of the nitrogen before treated water is discharged to streams. Septic systems may contribute biologically available nitrogen to groundwater.

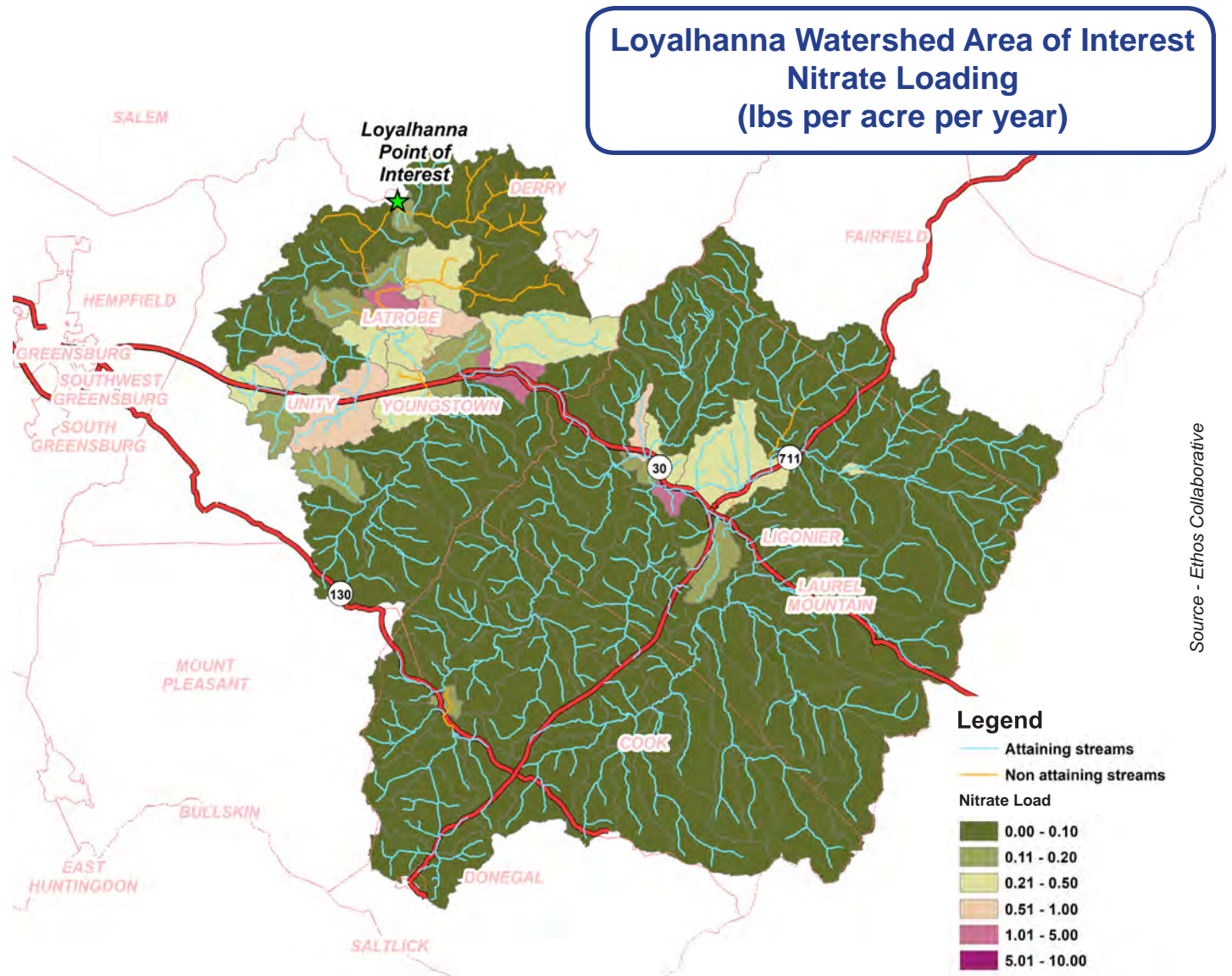

## TOTAL PHOSPHORUS (TP)

Phosphorus, here expressed as Total Phosphorus (TP) is a nutrient essential for life. Phosphorus, like Nitrogen, used to be a limiting nutrient for ecosystems. Industrial activities and fertilizer both contribute excess phosphorus to ecosystems. This phosphorus contributes to algae blooms in water bodies, eutrophication, and overall habitat deterioration. Shown on the map is the modeled sub-watershed export of TP in pounds per year.

- Higher amounts of phosphorus are exported from the urban sub-watersheds in the Loyalhanna AOI. Phosphorus is sourced primarily from lawn fertilizer and roadway deposition. These sources produce both particulate and dissolved forms of phosphorus.
- Soil erosion is another contributor of phosphorus to streamwater. Erosion depletes the soil of valuable nutrients like phosphorus and transports the nutrient downstream,.
- Crops lands export phosphorus to downstream environs, sourced from fertilizer applied to the fields. Fertilizer-sourced Phosphorus is likely in particulate forms, and therefore structural BMP's that filter and/or detain sediment and particles can help to mitigate downstream export.
- Wastewater contains phosphorus from human waste and detergents. Wastewater treatment plants may not remove all of the phosphorus before treated water is discharged to streams.

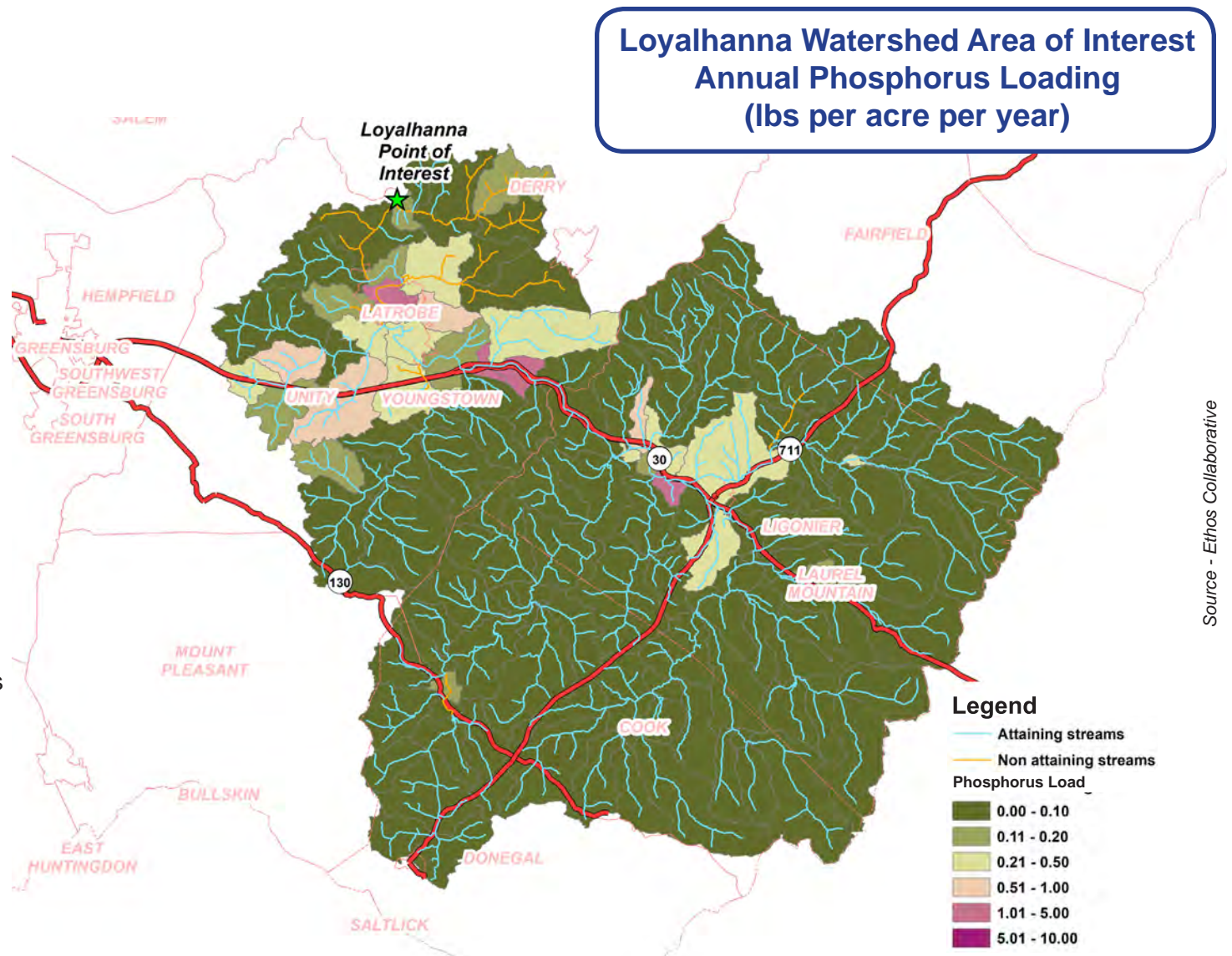

Source - Ethos Collaborative



## OPPORTUNITIES FOR EFFECTIVE STORMWATER MANAGEMENT:

Based on Modeling Watershed Hydrology and Pollution Sources to Inform Smart Water Management:

### To increase water quality, we must decrease overland water quantity.

The good water quality in this watershed is a valuable resource that should be conserved for future generations. Conservation efforts should consider ways to manage landscape-based runoff that decreases soil erosion, pollution transport, and sediment deposition in the healthy creeks and rivers. Water detained by increasing infiltration to groundwater encourages nutrient retention, or the uptake and filtration of pollutants by biota and soil. The processes of detention and retention increase water quality through decreasing erosion and downstream pollutant transport.

### Effective water management protects valuable resources and built infrastructure.

Recreational uses, high quality streams and woodlands in this watershed are valuable resources. Many homes and built infrastructure are subject to flooding during severe rain events where streams have been impacted by developments. Conservation efforts should consider ways to manage water runoff that decrease soil erosion, pollution transport, sedimentation, and flooding.

### Conceptual Ideas for BMP's/Landscape Restoration: Highlighting the potential for water and pollutant capture and retention.

Identified issues include stormwater runoff and associated erosion, as well as the identification of sites appropriate for Green Infrastructure such as stormwater retrofits, riparian buffer restoration, and stream restoration. When coupled with the landscape-based nutrient accumulation and decay modeling, this list can help to identify and prioritize projects for future conservation efforts. This list was compiled based on reports made by local property owners to the Westmoreland Conservation District and should by no means be considered an exhaustive list of problem sites in the watershed.



Loyalhanna Creek, view from the causeway, autumn

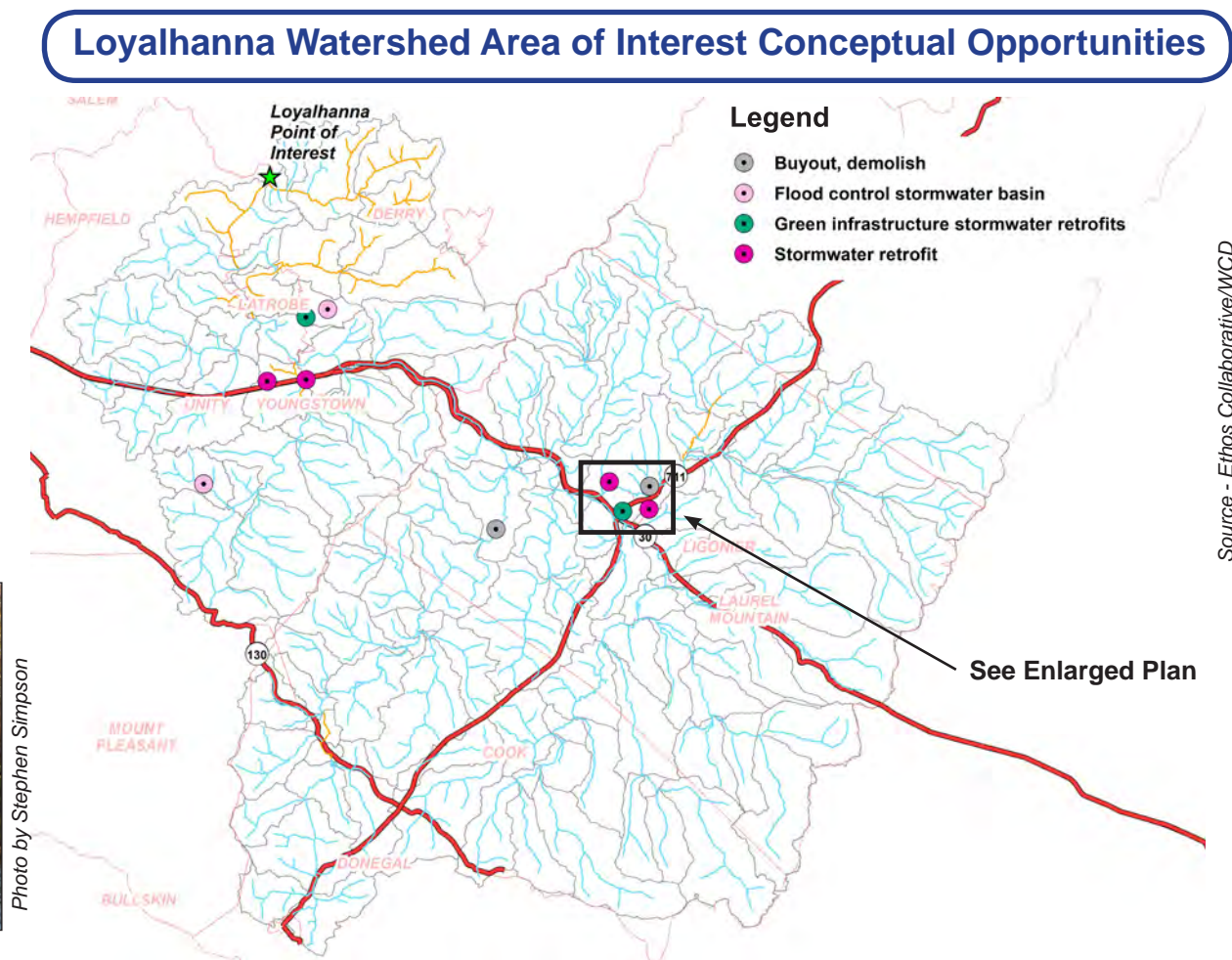

Source - Ethos Collaborative/WCD

Photo by Stephen Simpson

## CONCEPTUAL OPPORTUNITY: URBAN GREEN INFRASTRUCTURE STORMWATER RETROFITS

This area is located in Ligonier, a town located close to the Laurel Ridge. Here, we used GIS spatial method to determine the location of public parcels including parks and municipality-owned lots. These public parcels were chosen because it would be easier to enact Green Infrastructure on areas that were not privately owned. Parcels of interest are color-coded to indicate the modeled amount of sediment, in lbs per year, that may be exported from these properties. This example shows how the sediment/pollution modeling (1) pinpoints regions of concentrated pollution, and (2) helps to guide efforts to find accessible areas where stormwater and pollution mitigation efforts can be enacted.

### Water Quality Goals:

During rain events, water collects and runs off of impervious surfaces, carrying with it pollution including Suspended Solids (TSS), Phosphorus (TP), and Nitrate ( $\text{TNO}_3^-$ ). Best management practices that slow overland flow, encourage water and particle infiltration/ settling and increasing biological processing interactions would help to mitigate the effect of stormwater flow. Stormwater management potential landscape elements to consider will affect impacts of stormwater management.

### Stormwater Management Potential:

Protecting streambanks from erosion and retrofitting infrastructure in the urban areas to include green infrastructure would help decrease flooding and pollution inputs delivered to the streams in storm runoff.

### Landscape Elements to Consider:

Shade in urban areas and along stream channels reduces thermal pollution and contributes to stormwater volume reduction through evapotranspiration.

### Water Quality Impacts of Stormwater Management:

The inclusion of green infrastructure in urban areas and augmenting riparian buffers will reduce stormwater runoff and allow pollutants to break down through natural processes rather than degrading streams.

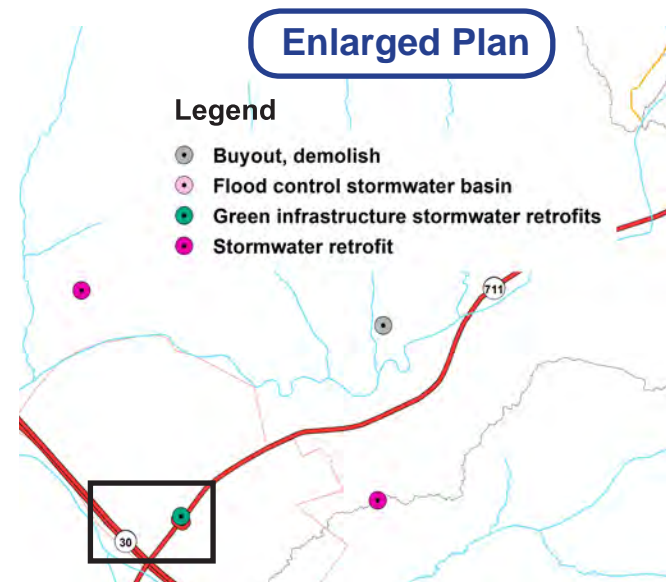

Enlarged plan of Ligonier, Loyalhanna Watershed Area of Interest indicating impacts and opportunities for BMPs



# MONONGAHELA RIVER WATERSHED AREA OF INTEREST

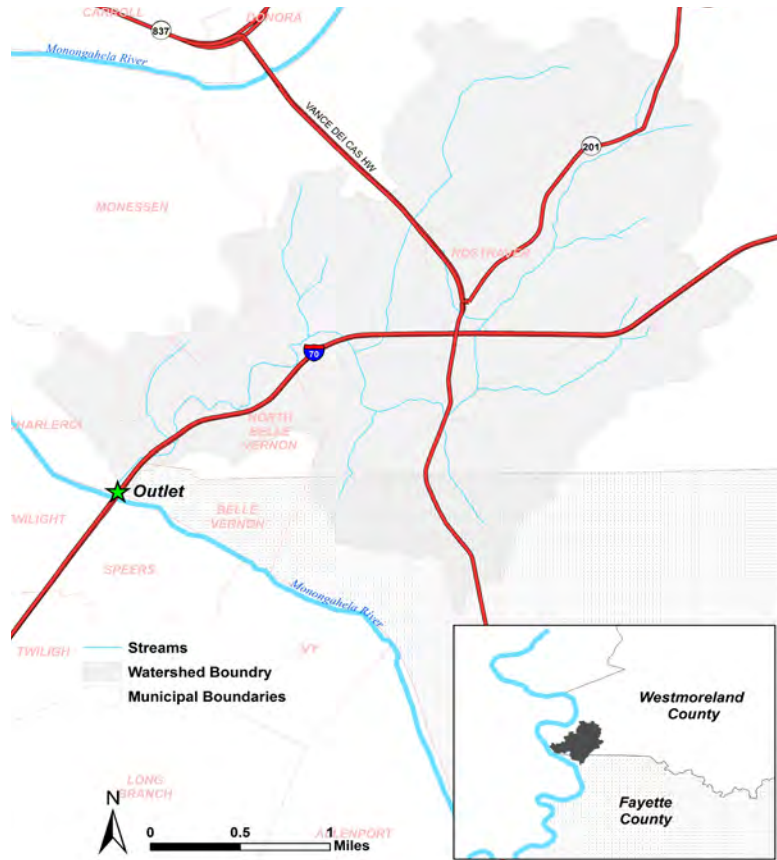

Source - Ethos Collaborative

## REGION OVERVIEW

The Monongahela Area of Interest is approximately 6.8 mi<sup>2</sup>/4,352 acres and contains 14 miles of streams that drain southwest to the Monongahela River in Belle Vernon (outlet indicated by a star on the map, left). The main stream draining this landscape is Speer's Run. Seven sub-watersheds were delineated ranging from 0.07 to 2.56 square miles in size. Most sub-watersheds were in the range of 1-2 square miles.

### Why is this watershed of particular interest?

During the Phase I assessment, it was noted that this small watershed has great potential for rapid development. The I-70 corridor provides quick access to rapidly growing areas around Washington that service the oil and gas industry. The largely rural landscape leaves room for future expansion of residential or industrial areas. There is tremendous opportunity to carefully manage future development and stormwater planning in this area.

### Challenges in the Watershed

The city of Monessen and Rostraver Township are required to develop and implement a Pollutant Reduction Plan (PRP) for discharges from the municipal separate sanitary sewer system to impaired streams, including an un-named tributary to Speers Run. Proposed solutions include storm sewer inserts to capture sediment and debris, and restoration of natural drainageways.

### WATERSHED SNAPSHOT

- **Area:** 6.8 square miles
- **Water Quality:** Impaired for aquatic life, due to inputs from suburban lands and abandoned mines.
- **Characterization:** This area of interest is a mix of forested and developed land.
- **Highways** provide relatively quick transportation from this rural region to the cities of Pittsburgh and Greensburg. These qualities make the region an ideal location for future development.

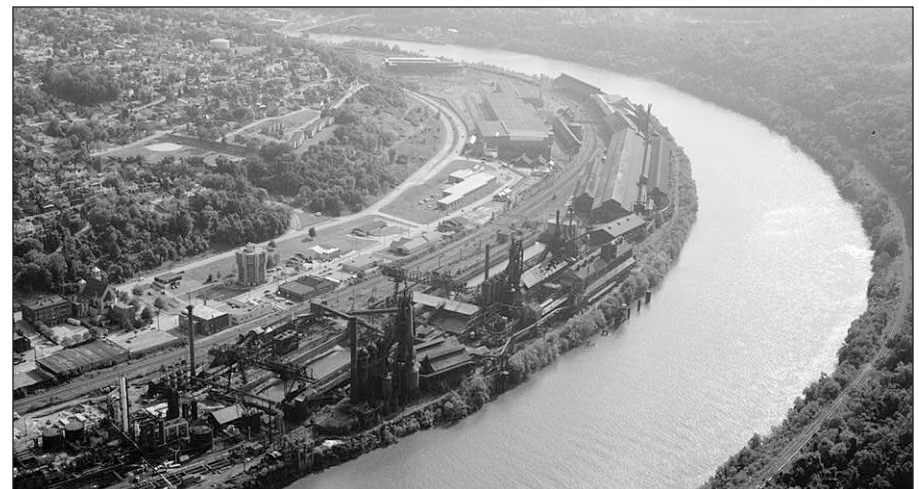

City of Monessen Waterfront - 1955

Source - historic-structures.com

## Landcover / Landuse

Landcover in this watershed is predominantly deciduous forest and low-moderate intensity developed land, with concentration of urbanized land and associated impervious surface around the town of Belle Vernon and the Interstate 70 corridor. There is also a good proportion of land in hay/pasture. Landcover data is based on the 2011 National Land Cover Dataset, created by the Multi-resolution Land Characteristics Consortium (MRLC). Refer to [www.mrlc.gov](http://www.mrlc.gov) for methodology.

Landcover Class	Acres	Total Area (%)
Open Water	1	0.01
Developed- Open Space	385	9
Developed- Low Intensity	651	15
Developed- Medium Intensity	468	11
Developed- High Intensity	177	4
Barren Land	122	3
Deciduous Forest	1787	41
Mixed Forest	2	0.04
Hay/Pasture	716	16
Cultivated Crops	44	1



City of Monessen Waterfront - Present day

## Monongahela River Area of Interest Landcover Classification

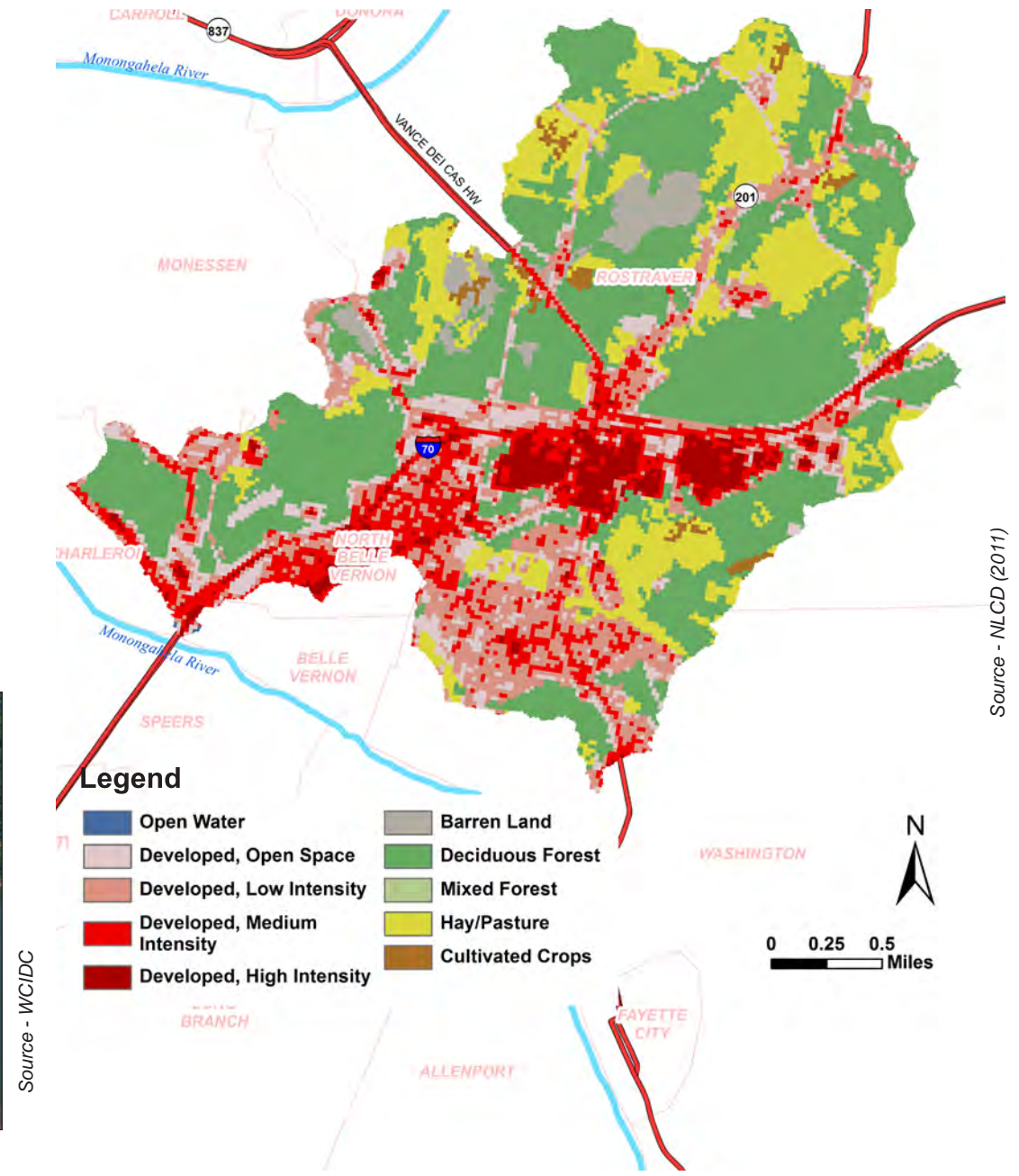



## CURRENT WATER QUALITY IN THE MONONGAHELA RIVER WATERSHED AREA OF INTEREST

### Non-point source pollution

In all, the Pennsylvania Department of Environmental Protection determined that all of the stream miles in the Monongahela Area of Interest are considered “impaired” for their designated use of maintaining aquatic life. Identified impairments include nutrients and siltation from residential land and road runoff, as well as metals and pH from Abandoned Mine Drainage. These are considered non-point sources, originating not from one identifiable point but instead from diffuse sources across the landscape.

### Monongahela River Area of Interest Attaining & Impaired Streams

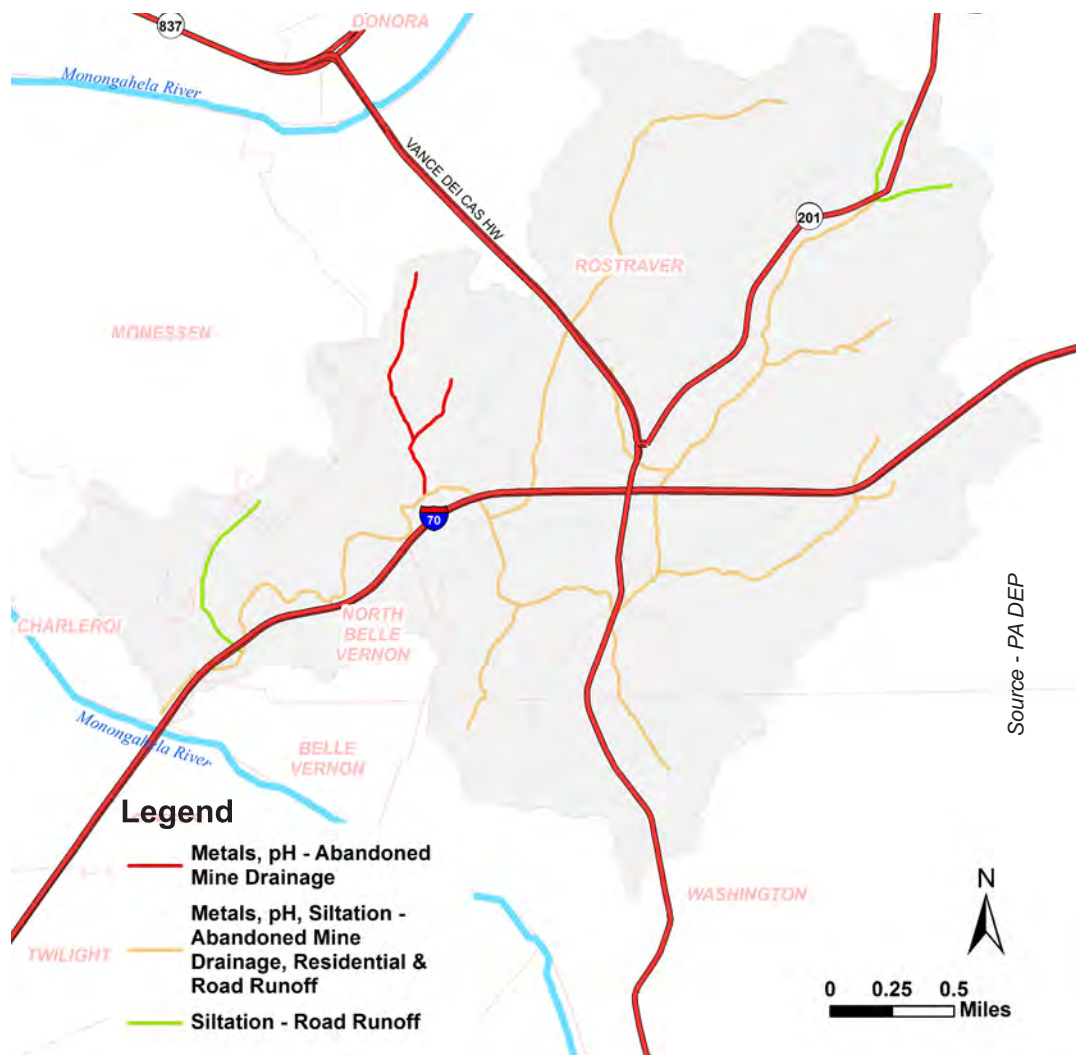

### TMDL status of the streams in this area of interest

Although these streams are identified as impaired, they are not currently listed under a TMDL, (Total Maximum Daily Load) agreement. However, the Monongahela River at this location is under a TMDL for PCB's and Chlordane, the “Monogahela River TMDL.” This agreement seeks to reduce the non-point sources of pollution from PCB's (from industrial processes) and Chlordane (once a common pesticide, now banned by the EPA). Although both chemicals are banned, sediment-bound chemicals are environmentally persistent and bio-accumulate in fish.



Abandoned Mine Drainage Pollution

Source - WPCAMR

## WATER QUALITY AND WATER QUANTITY ARE INEXTRICABLY LINKED IN THE MONONGAHELA AREA OF INTEREST

As water accumulates and moves overland on impervious surfaces, it picks up pollutants from the surface of the landscape and delivers it to receiving waters. Development, particularly that which increases impervious surfaces on the landscape, increases the overland flow of water during storms and decreases infiltration to groundwater. Increased stormwater also increases the erosive force of overland flow, increasing sediment load and delivering it to downstream receiving waters. Below, a watershed map shows the concentration of impervious surface in the Area of Interest. Impervious surface data is from the 2011 National Land Cover Dataset.

Both sediment and pollution are a threat to water. Accumulated nutrients can lead to harmful algae blooms, which may affect wildlife habitat and water quality. Sediment accumulation in larger rivers represents the erosion, and loss, of valuable soil from upstream landscapes. The sediment is also a threat in the future as it continues to accumulate and add to stream bedloads.

### Monongahela River Area of Interest Impervious Cover

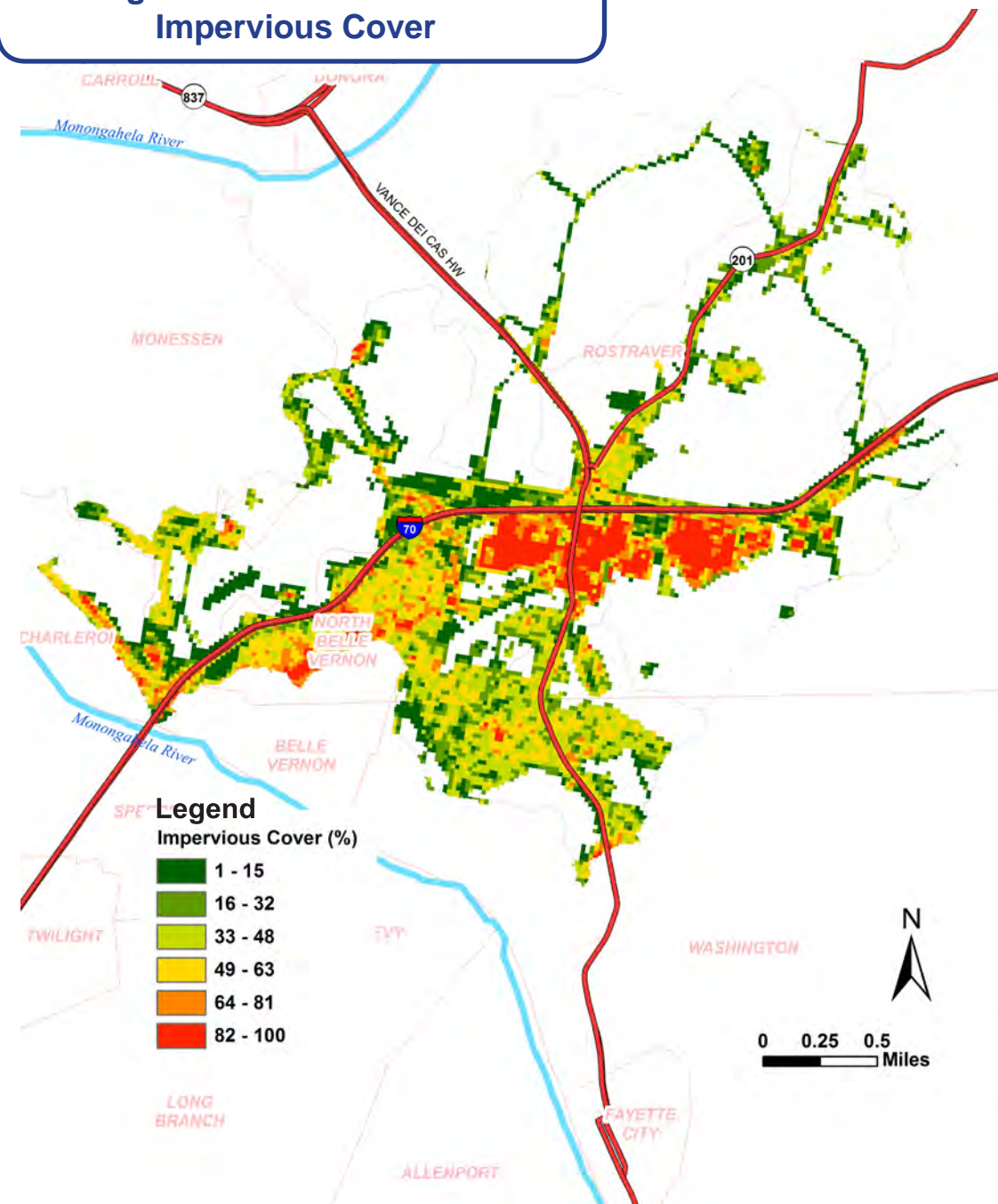



## FUTURE TRENDS IN THE MONONGAHELA RIVER WATERSHED AREA OF INTEREST





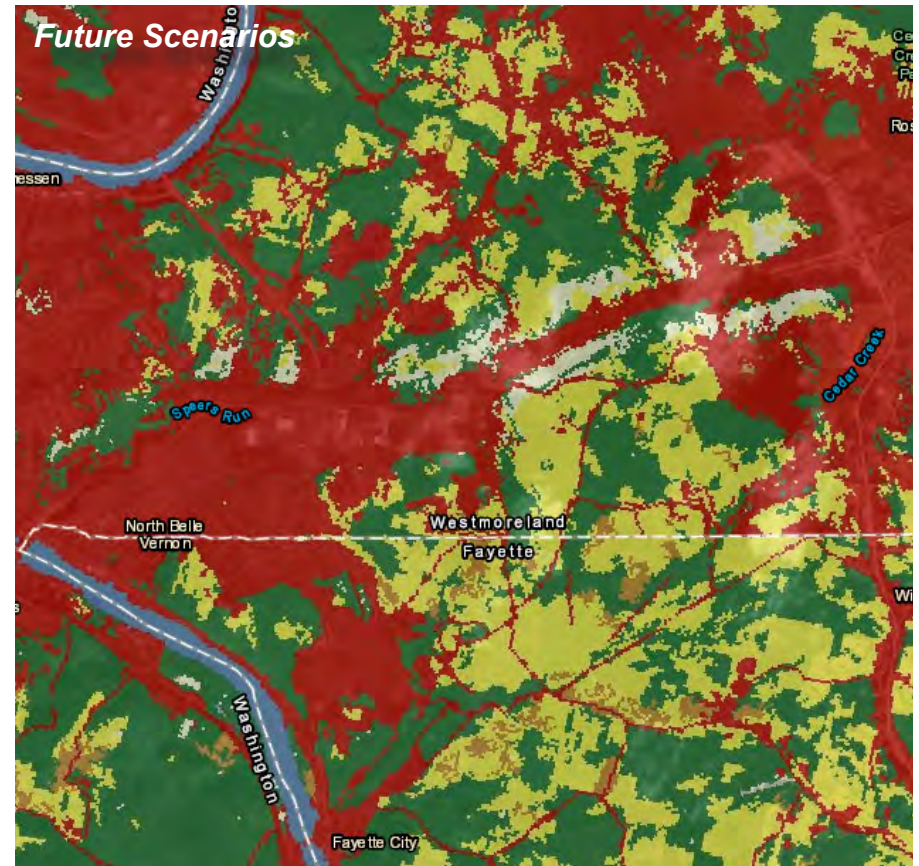
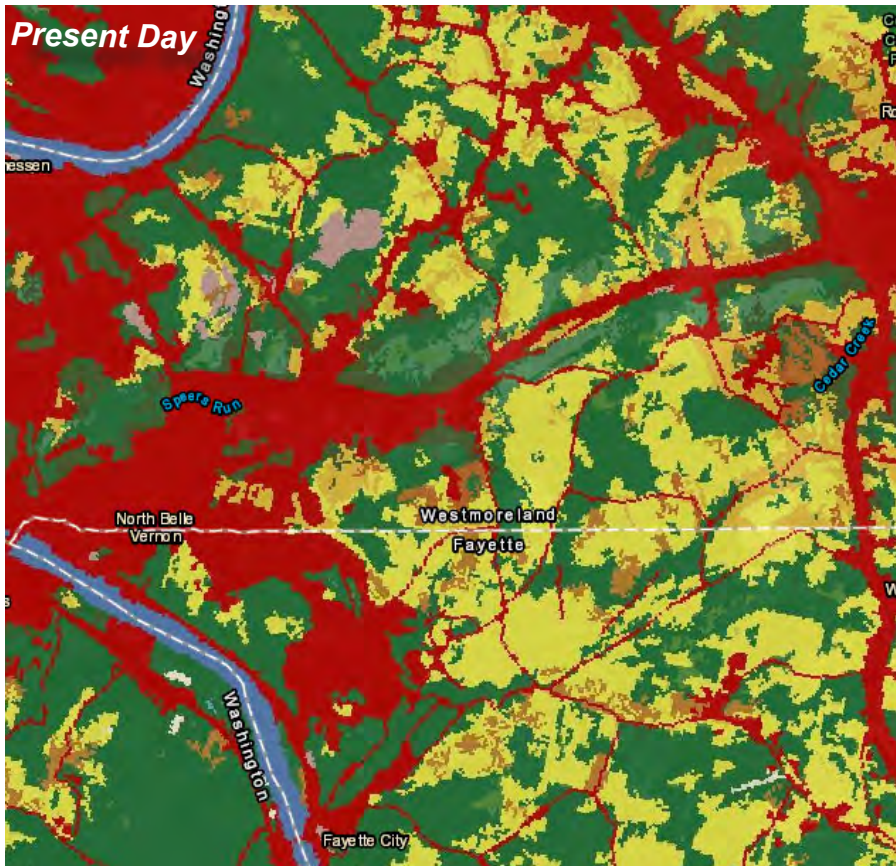





This watershed will likely see increasing development and a reduction in forested and agricultural land. These land-use trends will add to stormwater runoff and non-point pollution loadings. There is tremendous opportunity to carefully plan now in order to

mitigate the potential increase in flooding and pollution delivery downstream. The projections below are compiled from the ESRI GREEN INFRASTRUCTURE Online Mapping tool, developed in conjunction with the Clark Labs (<http://www.esri.com/about-esri/greeninfrastructure>).



### Legend

National Land Cover Database

 Open Water	 Grassland/Herbaceous
 Perennial Ice/Snow	 Pasture/Hay
 Developed	 Cultivated Crops
 Barren Land (Rock/Sand/Clay)	 Herbaceous and Woody Wetlands
 Forests	
 Scrub/Shrub	

### Specific predictions of change in land-use

Above, a visual comparison of land use in 2011 versus predicted land use in 2050 highlights the forecasted increase in impervious surfaces. This analysis of land use change in the Monongahela Area of Interest specifically estimates

- A 35% *INCREASE* in developed land,
- A 15% *DECREASE* in forest cover
- A 33% *DECREASE* in agricultural cropland

Source -ESRI



## HYDROLOGIC WATERSHED MODELING:

### INPUT PARAMETERS, MODEL CALIBRATION & FINAL RELEASE RATES FOR THE MONONGAHELA AREA OF INTEREST

Controlling water now and in the future requires an understanding of current conditions and pollution sources. *Parameters* below and on the following pages were used in hydrological models to help us understand the contribution of different sub-watersheds to the flow of the whole, and possible future changes.

#### Hydrologic Soil Groups in the Monongahela Area of Interest

The map below is color-coded by the Hydrologic Soil Group, which indicates a soil's water holding capacity. Group A soils have low runoff potential and high infiltration rates, while Group D soils show the highest runoff potential with very low infiltration rates. Also shown are the specific soil names, please see appendix for a list and descriptions of individual soil types.

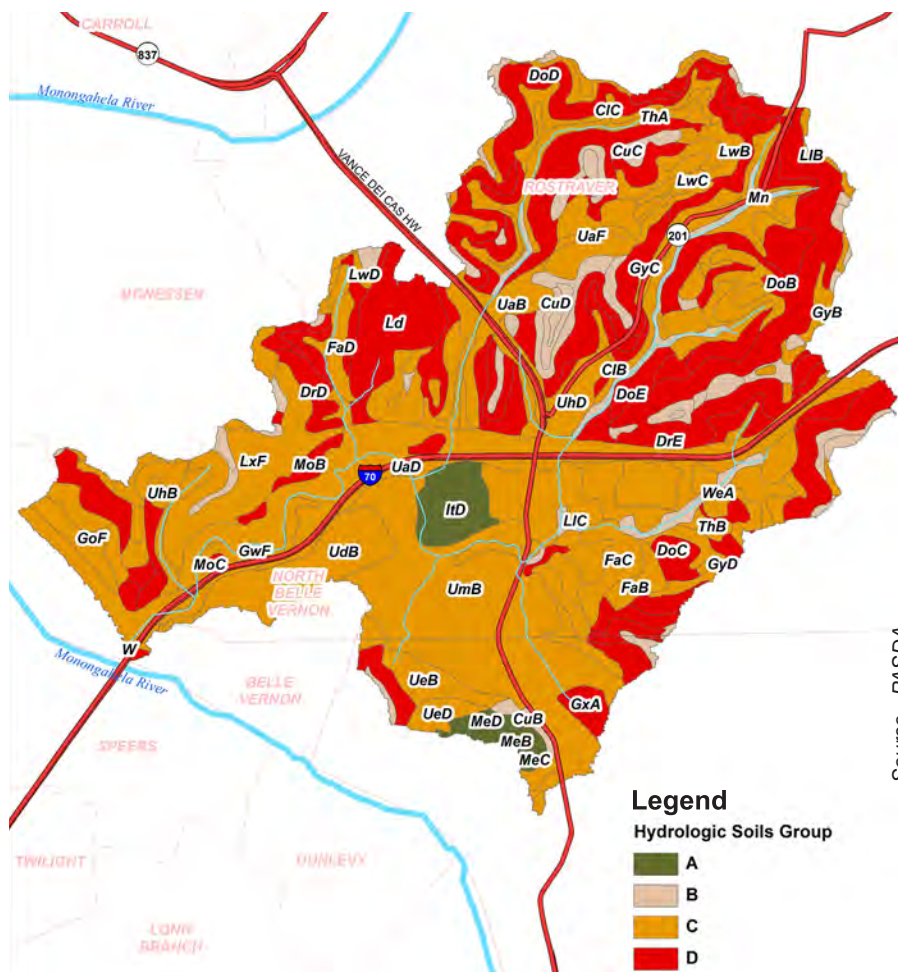

Source - PASDA

*Basin Curve Numbers ("CN's") in the Monongahela Area of Interest* are an empirical parameter that helps to predict direct runoff/infiltration from a parcel of land during a rain event. In the Monongahela area of interest, these range from 74-83. Watersheds with a higher curve number indicate higher runoff potential, leading to greater flooding and pollution delivery to streams.

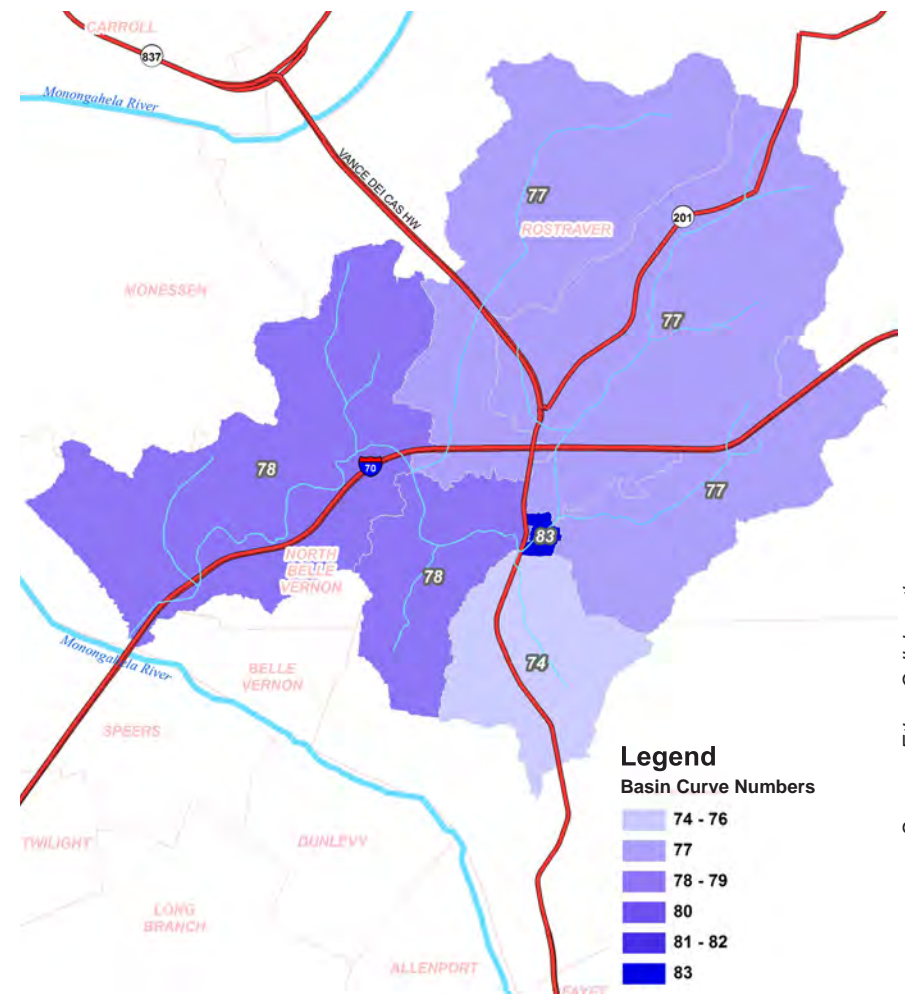

Source - Ethos Collaborative



**Average Basin Slope (%) in the Monongahela Area of Interest**

Generally most regions in this watershed show a moderate slope, with a range of values from 16.37% to 32.29%. Steeper slopes are found in the stream valleys and shallower slopes on the upland regions. Slope steepness contributes to overall runoff calculations, as steeper regions generally experience greater runoff during rain events.

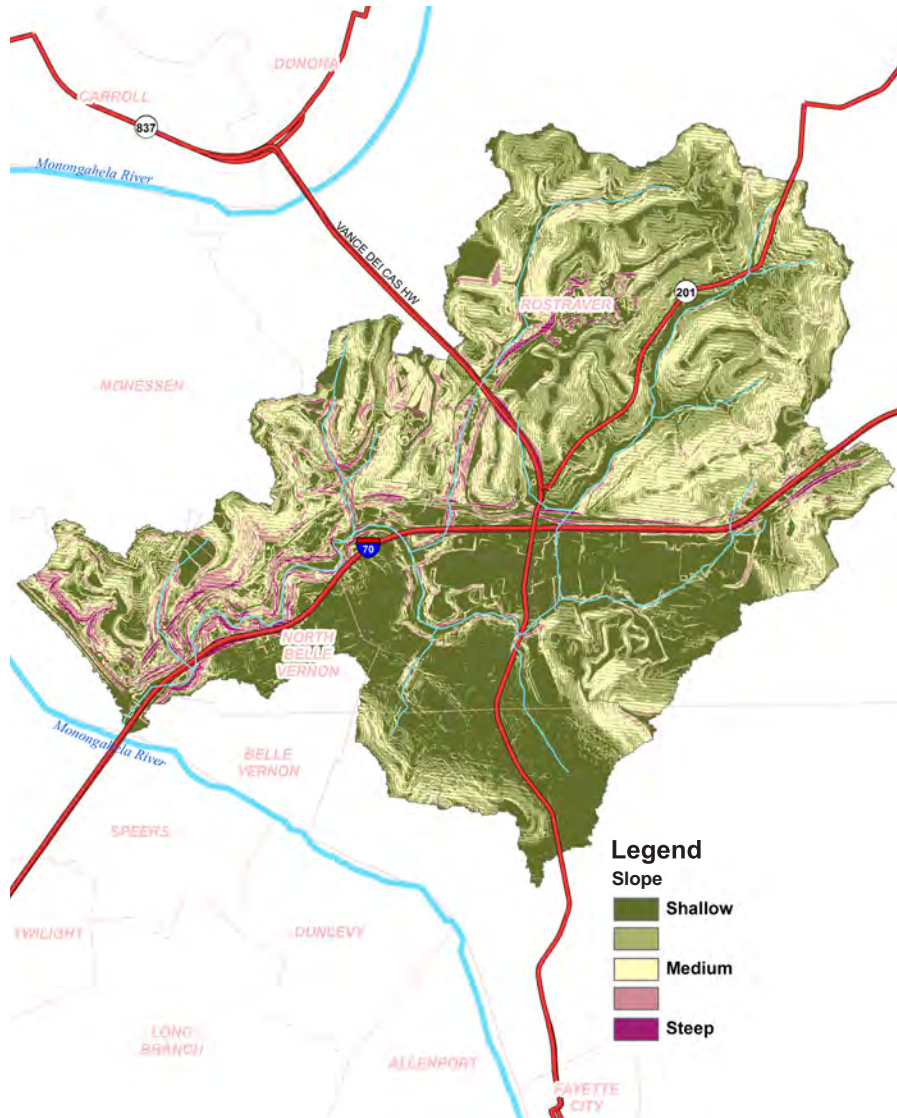

**The Basin Storage Ratio in the Monongahela Area of Interest**

indicates the proportion of each sub-watershed that can store water in a storm, instead of directly increasing stream discharge. Storage areas include lakes, ponds and floodplains. Storage ratios range from 0.0008 to 0.1999, therefore the storage amount available in each sub-watershed varies from 0.08-20% of the sub-watershed area.

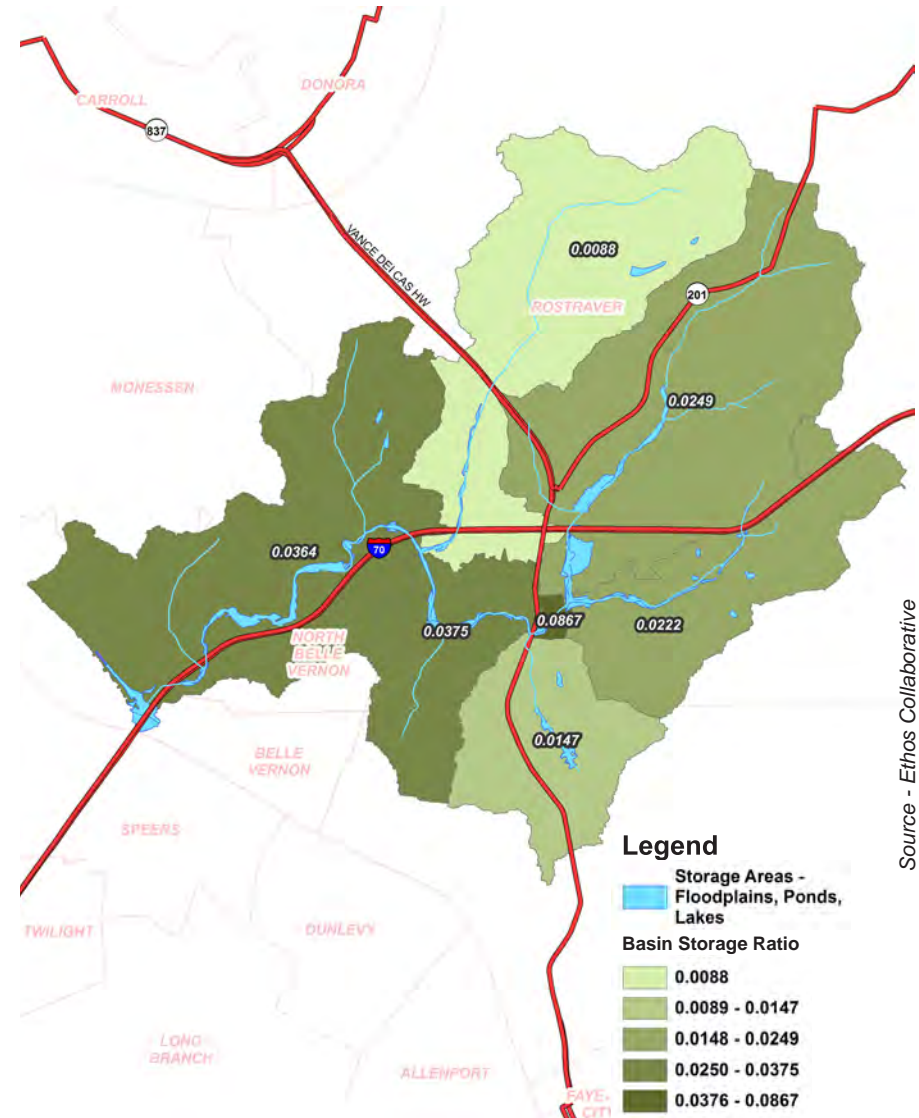

Source - Ethos Collaborative

## MODEL CALIBRATION IN THE MONONGAHELA AREA OF INTEREST

Four sites were chosen as “areas of interest” and model results at these sites were compared to Stream Stats data for the same site. This approach allowed the calibration of hydrological models, in the absence of multiple stream gage locations in the watershed. The graphs below compares Model Results versus StreamStats for the 2, 5, 10, 50, and 100 year storms. There is a good correlation between model results and Streams Stats data. For the methodology used for calibration, validating statistics and comparisons refer to the methodology in the appendix.





## RECOMMENDED RELEASE RATE MAP FOR THE MONONGAHELA RIVER WATERSHED AREA OF INTEREST

Release rates are a tool that help determine the timing of when water can be released from a watershed. A release rate of 50% for a sub-watershed indicates that the rate at which stormwater moves out of the watershed and downstream must be reduced by half in any future development. In contrast, a release rate of 100% indicates that, with future development, stormwater can move off of the sub-watershed at the same rate that is does in the present. In other words, lower release rates require an increased control of runoff.

Release rates were calculated based on a hydrologic model of the area of interest using HEC-HMS, the U.S. Army Corps of Engineers (USACE) Hydrologic Modeling System, in conjunction with GEO-HMS (a GIS extension that allows for the manipulation of spatial data).

Final calculated release rates show a range in value from 50-100%. Darker colors and lower release rates indicate regions where future development must reduce runoff rates.

It should be noted that the methodology to calculate release rates focuses on the basin-wide contribution of upstream land on downstream flooding. In order to control more localized flooding, individual municipalities may enact stricter stormwater runoff controls.

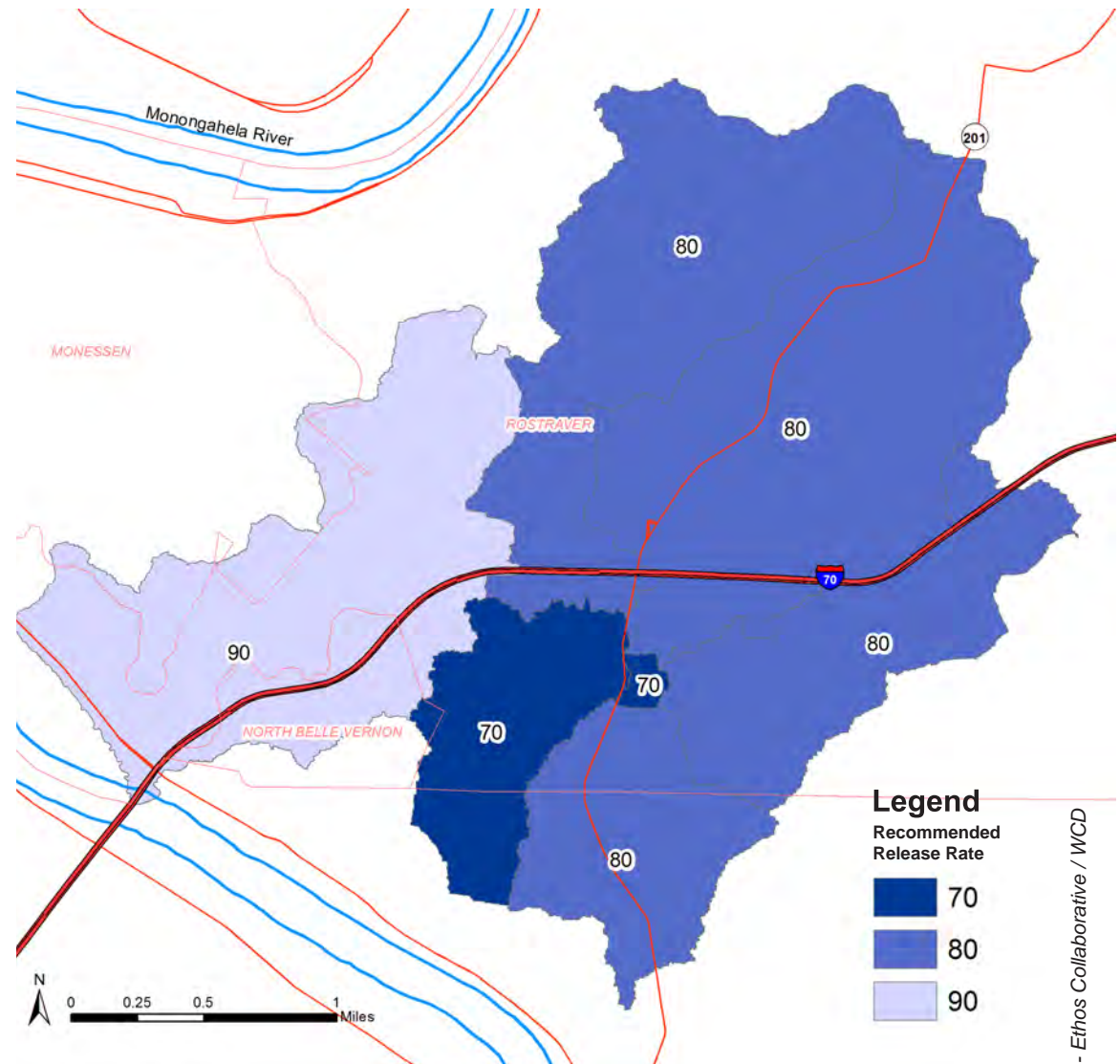

## LANDSCAPE POLLUTION ACCUMULATION MODELING

To understand where and how pollution-bearing runoff moves across the landscape, we modeled accumulation using ArcGIS in conjunction with a specialized terrain analysis toolset, (TAUDEM). This analysis allowed us to understand both pollution contributions and pollution reductions due to the underlying landscape. Please see the Methodology Appendix for further details about this process.

### TOTAL SUSPENDED SOLIDS (TSS)

Sediment, or Suspended Solids, encompasses any number of particulate pollutants or natural particles, from a myriad number of sources. Shown to the right is the estimated sub-watershed export of sediment, in pounds per year.

- The high percent of impervious surfaces in the town of Belle Vernon/North Belle Vernon and the nearby highway interchange collect solids during dry weather and then during wet weather contribute to high TSS loads draining from these watersheds. These sub-watersheds have little in the way of riparian buffers or other landscape features that help to slow, infiltrate, and absorb water, preventing it and associated pollutant loads from moving into the stream, and subsequently downstream.
- Significant contributions of TSS are also found in sub-watersheds where agricultural activities such as grazing and plowing take place. These regions in particular would benefit from the increase in riparian buffers as a way to capture water and associated pollutants before it reaches the stream.

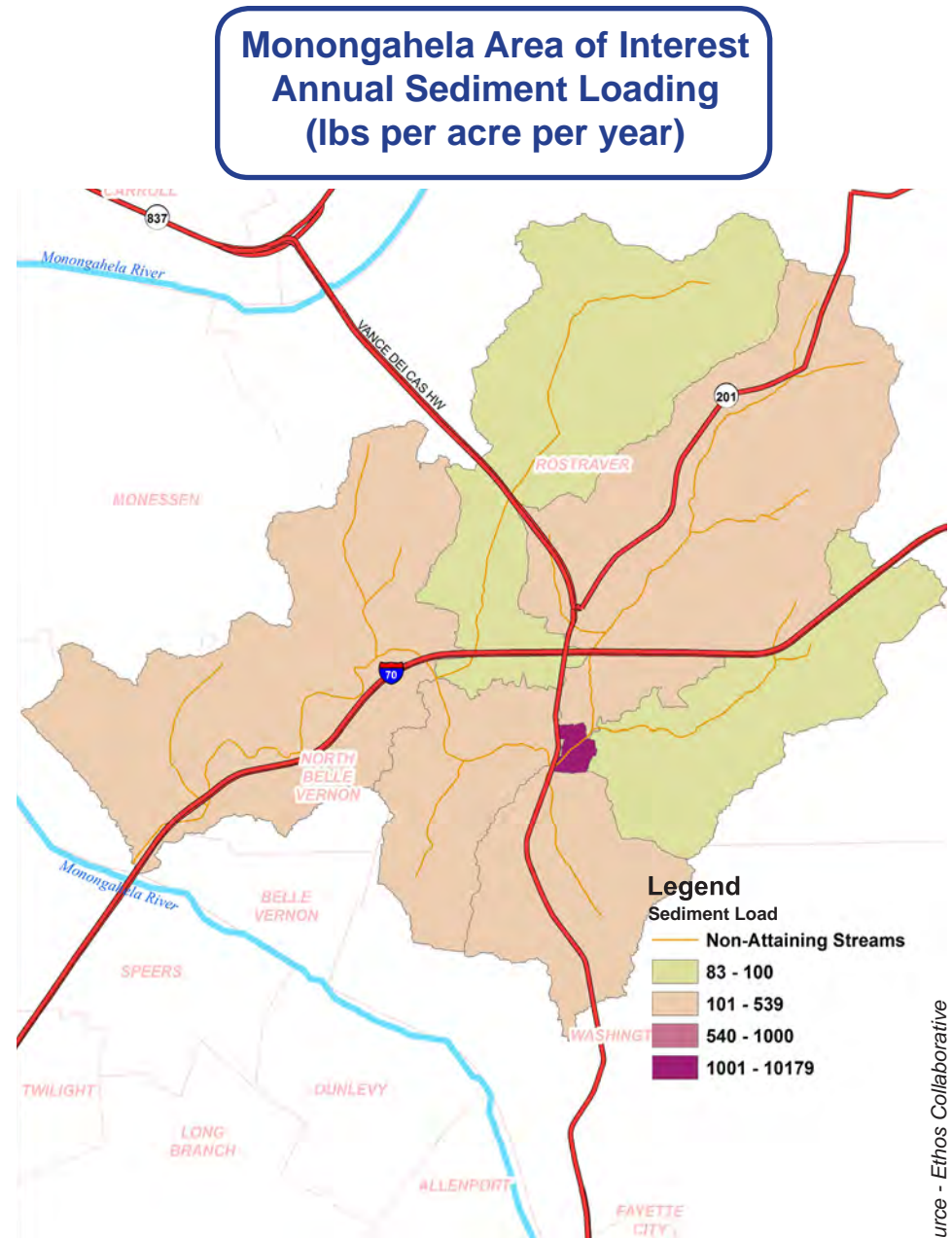

Source - Ethos Collaborative



## Monongahela Area of Interest Annual Nitrate Loading (lbs per acre per year)

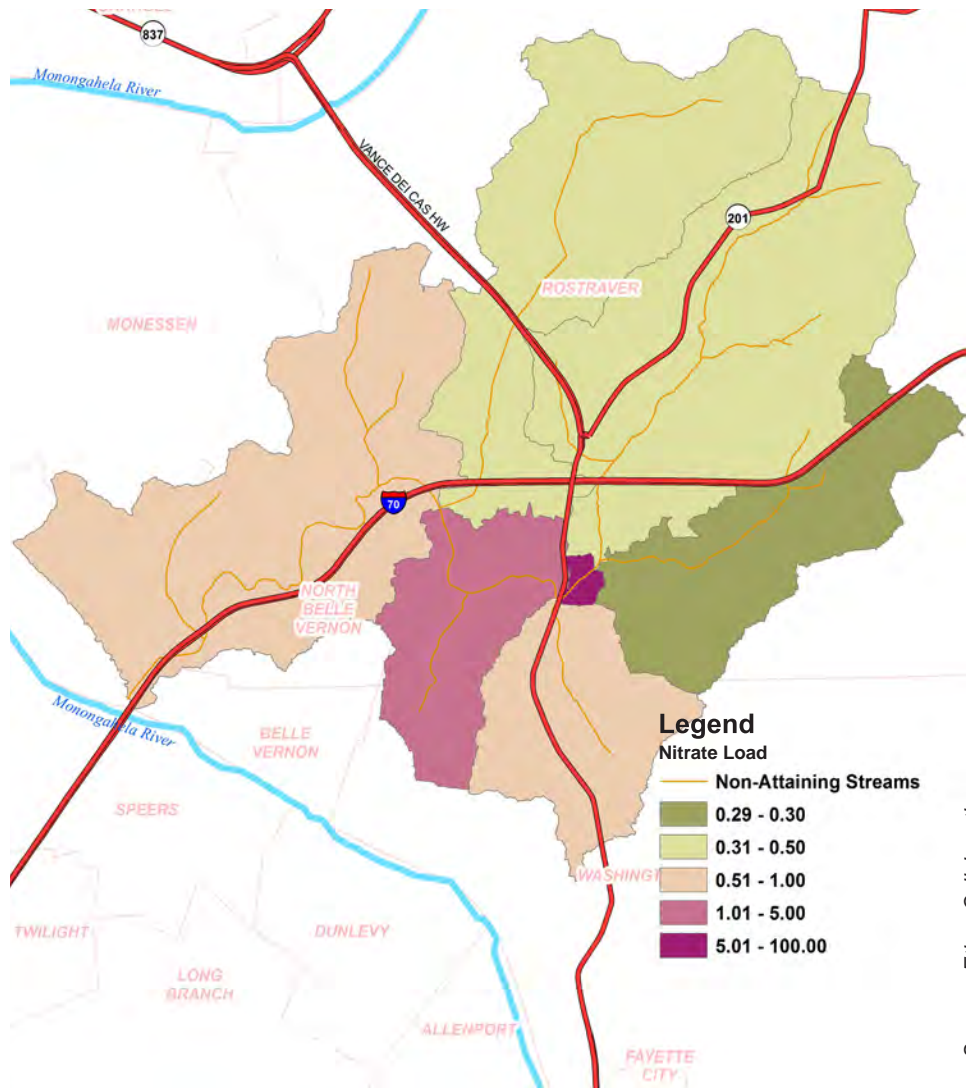

Source - Ethos Collaborative

## NITRATE (TNO<sub>3</sub>-)

Nitrogen, here expressed as nitrate (NO<sub>3</sub><sup>-</sup>), is a nutrient essential for plant and animal growth. Historically, biologically available nitrogen was a limiting factor in ecosystems, however industrial activities have increased biologically available nitrogen to the point where it is now considered a pollutant in many regions. Shown on the map to the right is the modeled sub-watershed export of nitrate, in pounds per year.

- Agricultural activities and residential areas both contribute fertilizer-sourced nitrogen to the watershed. Fertilizer applied to croplands and residential lawns can be washed from the land surface into streams.
- Nitrogen can be found in urine excreted from grazing animals. Urine-sourced nitrogen is biologically transformed to nitrate, which can then be transported downstream.
- Fixed nitrogen is emitted to the atmosphere when fossil fuels are burned. This nitrogen is deposited as nitrogen oxides or NO<sub>x</sub>, on the landscape, with concentrations found in near-road areas.
- Wastewater contains biologically available nitrogen. Wastewater treatment plants may not remove all of the nitrogen before treated water is discharged to streams. Septic systems may contribute biologically available nitrogen to groundwater.

## TOTAL PHOSPHORUS (TP)

Phosphorus, here expressed as Total Phosphorus (TP) is a nutrient essential for life. Phosphorus, like Nitrogen, used to be a limiting nutrient for ecosystems. Industrial activities and fertilizer both contribute excess phosphorus to ecosystems. This phosphorus contributes to algae blooms in water bodies, eutrophication, and overall habitat deterioration. Shown on the map to the right is the modeled sub-watershed export of TP in pounds per year.

- Higher amounts of phosphorus are exported from the more urbanized sub-watersheds and the developed regions around the interstate highway. Phosphorus is sourced primarily from lawn fertilizer and roadway deposition. These sources produce both particulate and dissolved forms of phosphorus.
- Soil erosion is another contributor of phosphorus to streamwater. Erosion depletes the soil of valuable nutrients like phosphorus and transports the nutrient downstream,.
- Crops lands export Phosphorus to downstream environs, sourced from fertilizer applied to the fields. Fertilizer-sourced Phosphorus is likely in particulate forms, and therefore structural BMP's that filter and/or detain sediment and particles can help to mitigate downstream export.
- Wastewater contains phosphorus from human waste and detergents. Wastewater treatment plants may not remove all of the phosphorus before treated water is discharged to streams.

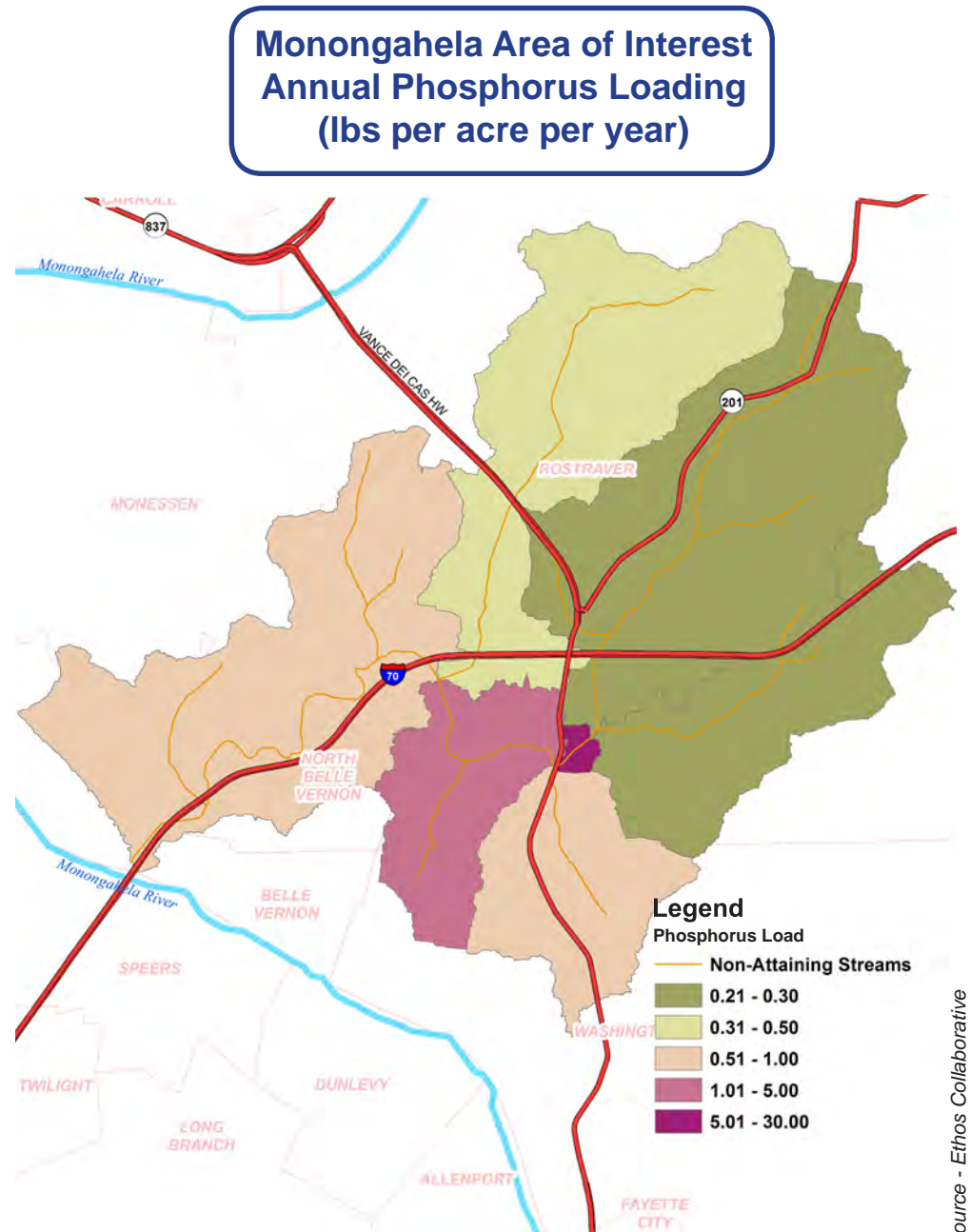

Source - Ethos Collaborative



# OPPORTUNITIES FOR EFFECTIVE STORMWATER MANAGEMENT

Based on Modeling Watershed Hydrology and Pollution Sources to Inform Smart Water Management:

## Effective water management protects valuable resources and built infrastructure.

The Monongahela River and the soil used in agricultural lands in this watershed are both valuable resources that must be conserved for future generations. Conservation efforts should consider ways to manage water runoff that decrease soil erosion, pollution transport, and sedimentation in the reservoir.

## To increase water quality, we must decrease overland water quantity.

Water detained by increasing infiltration to groundwater encourages nutrient retention, or the uptake and filtration of pollutants by biota and soil. Together, the processes of detention and retention increase water quality through decreasing erosion and downstream transport.

## Conceptual Ideas for BMP's/Landscape Restoration: Highlighting the potential for water and pollutant capture and retention.

Identified issues include stormwater runoff and associated erosion, as well as the identification of sites appropriate for Green Infrastructure such as stormwater retrofits, riparian buffer restoration, and stream restoration. When coupled with the landscape-based nutrient accumulation and decay modeling, this list can help to identify and prioritize projects for future conservation efforts.

## Opportunities for Effective Stormwater management

The sites identified below are considered "Opportunity Sites", or locations where known problems and the potential to fix the problems, both exist. This list was compiled based on reports made by local property owners to the Westmoreland Conservation District and by examination of the city of Monessen MS4 Pollution Reduction Plan ([http://cityofmonessen.com/ms4\\_program.html](http://cityofmonessen.com/ms4_program.html))

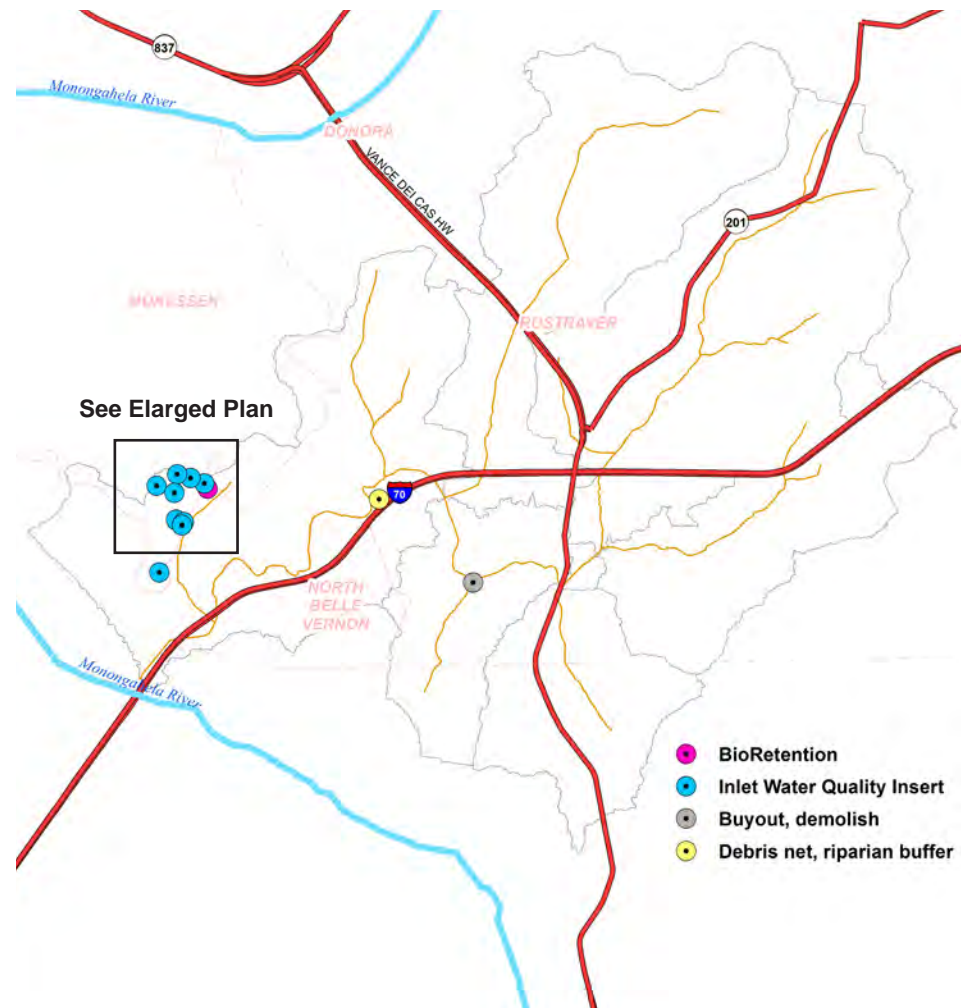

Source - Ethos Collaborative / WCD



Enlarged plan showing opportunities

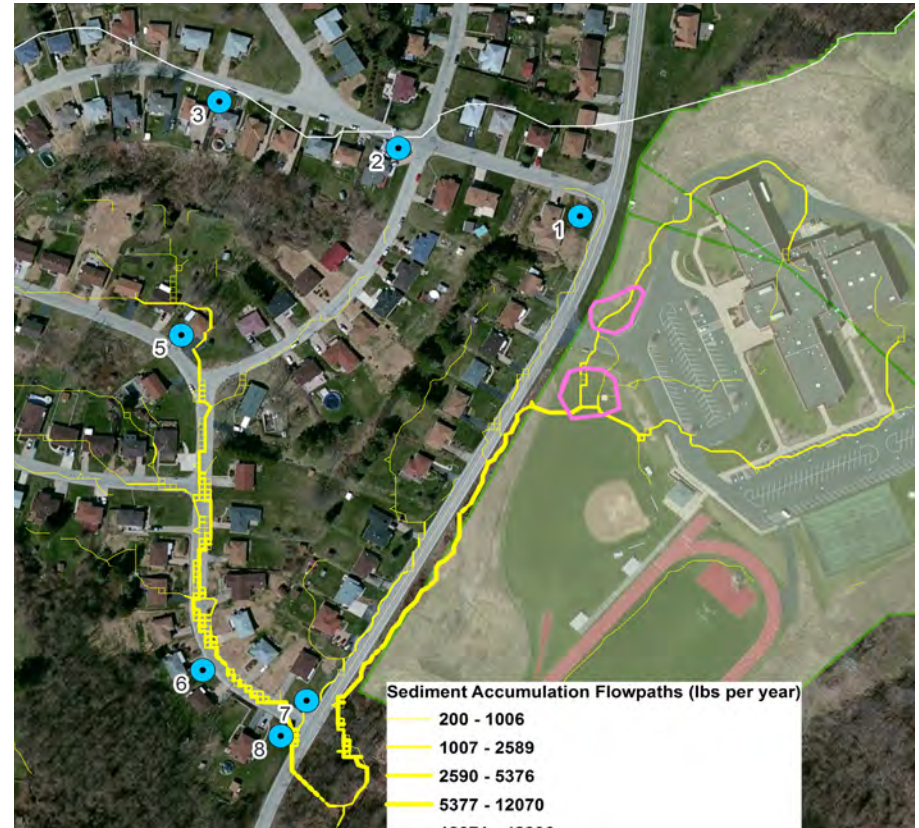

Enlarged plan indicating sediment acceleration

Source - Ethos Collaborative / WCD

## CONCEPTUAL OPPORTUNITIES IN THE MONONGAHELA RIVER AREA OF INTEREST

### Conceptual Opportunities: Bioretention Basin and Water Quality Inlet Control Structures

Above are the locations identified in the Monessen Pollution Reduction Plan, compiled by W.E.C., Inc. (Bridgeville, PA). W.E.C., Inc, proposed that the identified inlet structures be retrofitted with water quality control structures and that a BioRetention Basin be built on the grounds of the local high school.

### Water Quality Impacts of Stormwater Management

Retrofitting inlet structures would improve water quality by reducing a suite of pollutants including sediment, suspended solids, oil and grease, that are entrained in stormwater. The BioRetention Basin would aim to capture a similar range of material washing off of the roofs and parking lots of the school property.

### Conceptual Opportunities: Modeling to Inform Decision Making

Modeling the flow pathways and sediment accumulation provides valuable data to identify project priorities. For example, above the yellow lines indicate sediment accumulation pathways. These lines indicate that installing the Inlet Water Quality Inserts would likely be most effective at the lower part of the area of interest (inlets 5-8), rather than at the top (inlets 1,2,3) where they appear to receive less accumulated stormwater.

### Water Quality Impacts of Stormwater Management

The Monessen High School grounds are shaded above. Surface flow paths show two areas (outlined in pink) that could potentially capture surface runoff and detain it either in a BioRetention basin (top pink area) or underground storage (bottom pink area).



# PUCKETA CREEK, PLUM CREEK, ALLEGHENY RIVER WATERSHEDS AREA OF INTEREST

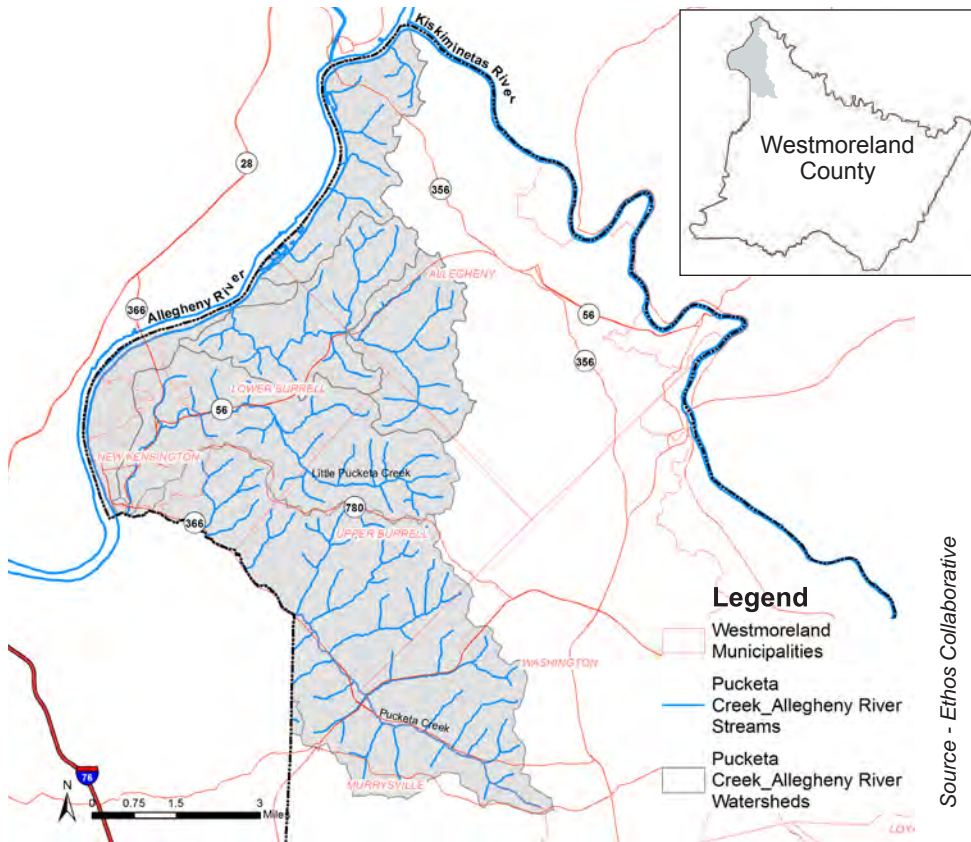

Source - Ethos Collaborative

## REGION OVERVIEW

The Pucketa Creek, Plum Creek, Allegheny River Area of Interest is approximately 51mi<sup>2</sup>/32,640 acres and contains 112.94 miles of streams that drain west eventually into the Allegheny River. The Area of Interest contains several subwatersheds and streams of interest including Pucketa Creek, Little Pucketa Creek, and Chartiers Run. The landcover is primarily deciduous forest and low intensity development and open space. The urbanized land exists in a concentration on the western edge of the watershed, along the Allegheny River, in the form of the City of New Kensington, the City of Arnold, and the City of Lower Burrell. The watershed also contains several state highway corridors including Route 56, Route 366, and Route 780 which serve as conduits for both vehicles and stormwater.

## Why is this watershed of particular interest?

This region has some historic flooding problems caused by development in low lying land and constant sprawling housing developments that radiate out from the historic urban centers of the City of New Kensington and the City of Lower Burrell. The region also contains very steep slopes that form multiple subwatersheds that rapidly flow into the main stems of Pucketa Creek, Little Pucketa Creek, and Chartiers Run causing flash flooding and sediment accumulation.

## Assets in the Watershed

A majority of the region is covered under one of the three MS4 permits that exist for the City of New Kensington, the City of Lower Burrell, and Allegheny Township. They are all currently in the process of meeting these MS4 requirements which has led to the engagement of several local engineering firms to produce Pollutant Reduction Plans that will inventory current stormwater related systems and develop plans to implement projects with the intent of improving water quality. The Westmoreland Conservation District has historically engaged with local governments in the region to implement several water quality pilot projects.

## WATERSHED SNAPSHOT

- **Area:** 51 mi<sup>2</sup>/32,640 acres
- **Water Quality:** Impaired for aquatic life due to abandoned mine drainage, siltation, nutrients, metals, and residential runoff.
- **Characterization:** This area of interest consists largely deciduous forested and low intensity development and open space with urbanized areas in the west.
- **The City of New Kensington is the most densely populated region of this watershed and is currently working to reduce pollution as part of an MS4 Pollution Reduction Plan.**

## Pucketa Creek, Plum Creek, Allegheny River Area of Interest Landcover Classification

### Landcover / Landuse

Landcover in this region is predominantly deciduous forest due to the geographic nature of steep forested valleys that form the subwatersheds of Pucketa Creek, Little Pucketa Creek, and Chartiers Run. These forested subwatersheds are dotted with sprawling housing developments that appear as the topography allows. The lower lying areas of the region typically are associated with the main stem of the streams listed above and also contain higher concentrations of development. This mix of higher intensity development in low lying areas along main streams leads to significant flooding events in the region and legacy sediment accumulation. This accumulation of sediment in relatively flat, slow moving streams, leads to restricted flows especially at existing encroachments, such as bridges, and results in flooding.

Landcover data is based on the 2011 National Land Cover Dataset, created by the Multi-resolution Land Characteristics Consortium (MRLC). Refer to [www.mrlc.gov](http://www.mrlc.gov) for methodology.

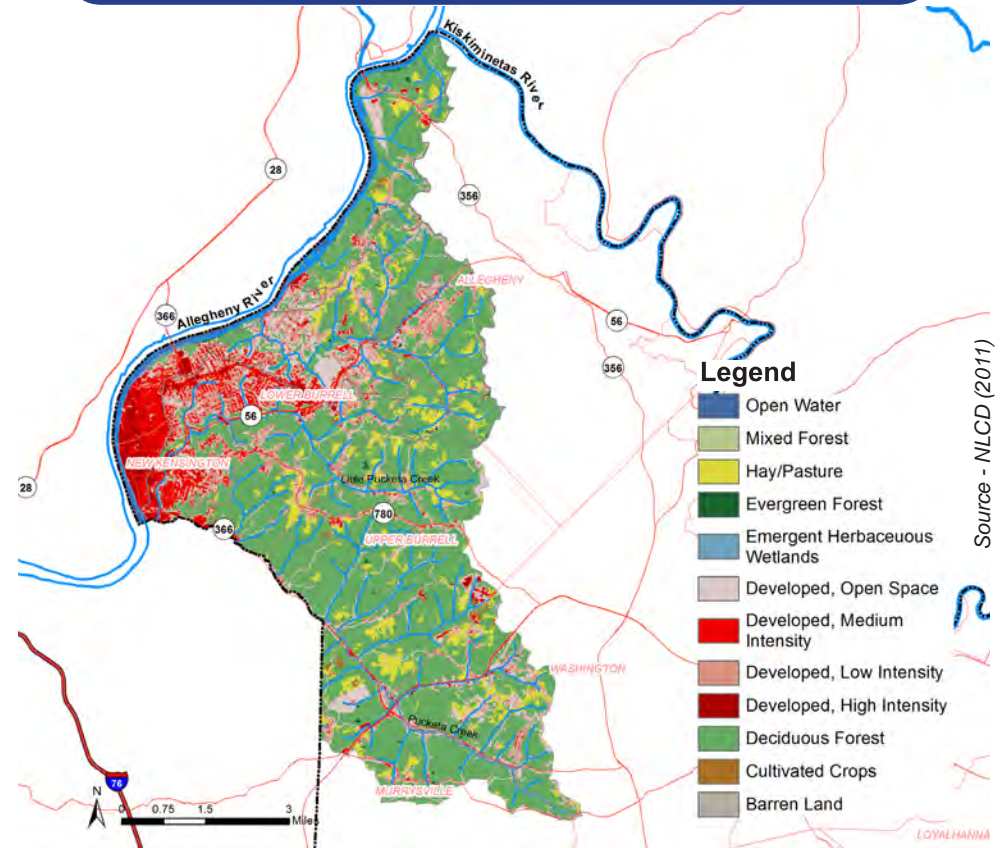

Landcover Class	Acres	Total Area (%)
Open Water	376	1.28
Developed, Open Space	3235	11.02
Developed, Low Intensity	3778	12.87
Developed, Medium Intensity	2084	7.10
Developed, High Intensity	622	2.12
Barren Land	21	0.07
Deciduous Forest	17003	57.91
Evergreen Forest	61	0.21
Mixed Forest	30	0.10
Shrub/Scrub	2074	7.06
Herbaceous	79	0.27
Hay/Pasture	14109	31
Cultivated Crops	3697	8.1



Little Pucketa Creek - Debris Basin

Source - NLCD (2011)

Photo by Rob Cronauer



## Pucketa Creek, Plum Creek, Allegheny River Area of Interest Attaining & Impaired Streams

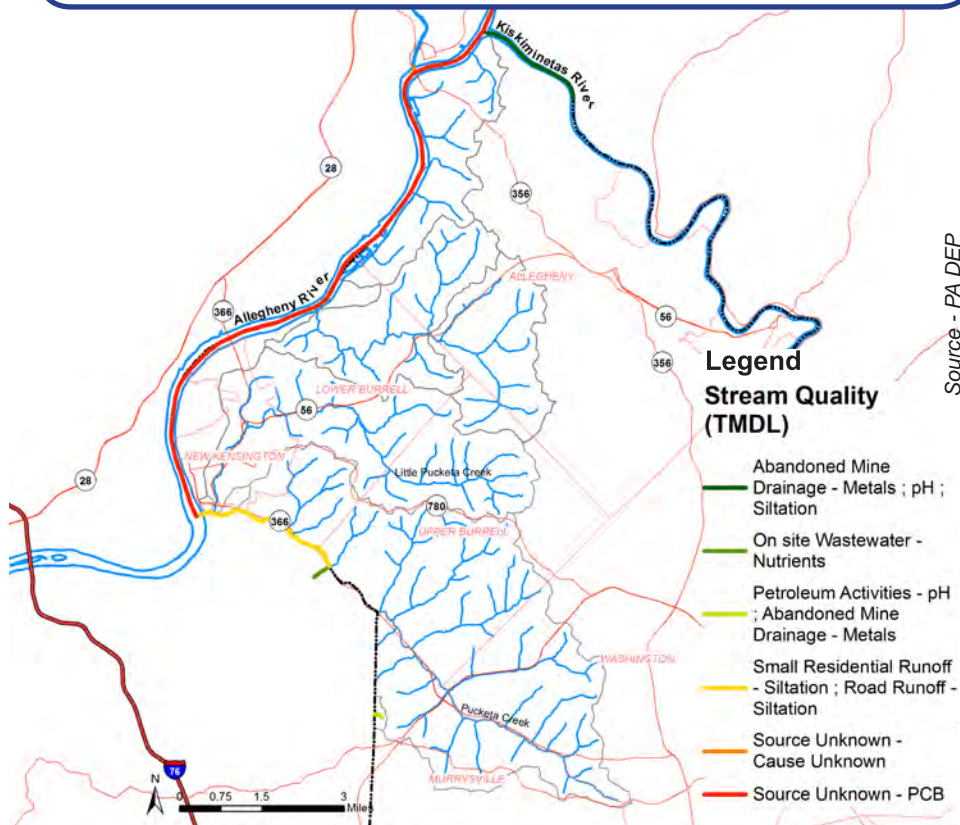

## CURRENT WATER QUALITY IN THE PUCKETA - PLUM - ALLEGHENY RIVER WATERSHEDS AREA OF INTEREST

### Non-point source pollution

In all, the Pennsylvania Department of Environmental Protection identified 98 stream miles as “attaining” their designated use of supporting aquatic life, 15 stream miles as “non-attaining” for that designated use, and the remaining are unclassified. Identified impairments include nutrients from on-site wastewater treatment, siltation residential runoff, as well as runoff and nutrients from derelict lands, and petroleum activities within the watershed. These are considered non-point sources, originating not from one identifiable point but instead from diffuse sources across the landscape.

### TMDL status of the streams in this area of interest

The primary TMDL contained within this watershed is a siltation issue along the lower stretch of Pucketa Creek. This excess sediment accumulation is not only harmful for aquatic life, but also contributes significantly to flooding in the region. The other primary TMDL’s exists in the section of the Allegheny River along the western edge of the region and in the Kiskiminetas River along the northern edge of the region. The only known source of impairment for these TMDL’s are Abandoned Mine Drainage points that exist throughout the area.



Stream Sampling for macroinvertebrates



Allegheny River at New Kensington



## WATER QUALITY AND WATER QUANTITY ARE INEXTRICABLY LINKED IN THE PUCKETA - PLUM - ALLEGHENY AREA OF INTEREST

As water accumulates and moves overland on impervious surfaces, it picks up pollutants from the surface of the landscape and delivers it to receiving waters. Development, particularly that which increases impervious surfaces on the landscape, increases the overland flow of water during storms and decreases infiltration to groundwater. Increased stormwater also increases the erosive force of overland flow, increasing sediment load and delivering it to downstream receiving waters.

Here, a watershed map shows the high concentration of impervious surface in the area of the City of New Kensington and then the intensity radiates out towards the City of Lower Burrell. From here the impervious surface follows the major highway corridors with residential developments forming pockets of impervious surface throughout the region. Even though a majority of these developments have stormwater detention systems, several are designed to outdated standards which do not adequately address rate release for smaller storms, such as the 2 year/24 hr storm. These storms can produce significant concentrated flows from the developments that contributes to flooding, erosion, and general pollutant transport downstream.

As stormwater runoff increases, so does the water's capacity to carry sediment and nutrients such as Nitrogen and Phosphorus. Stormwater may drop sediment and pollutants when the flow/energy of the water decreases. Both the sediment and the pollution are a threat to water. Accumulated nutrients can lead to harmful algae blooms, which may affect wildlife and water quality in the reservoir. The sediment accumulation represents the erosion, and loss, of valuable soil from upstream landscapes.

## Pucketa Creek, Plum Creek, Allegheny River Area of Interest Impervious Cover

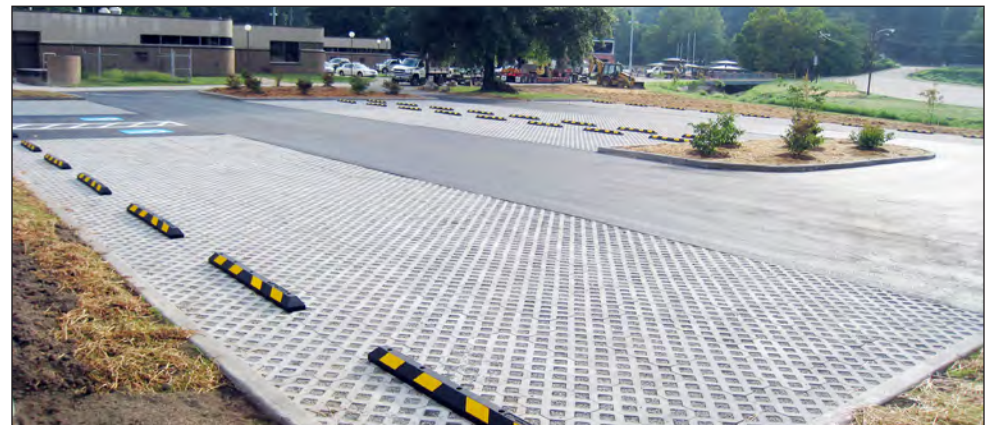
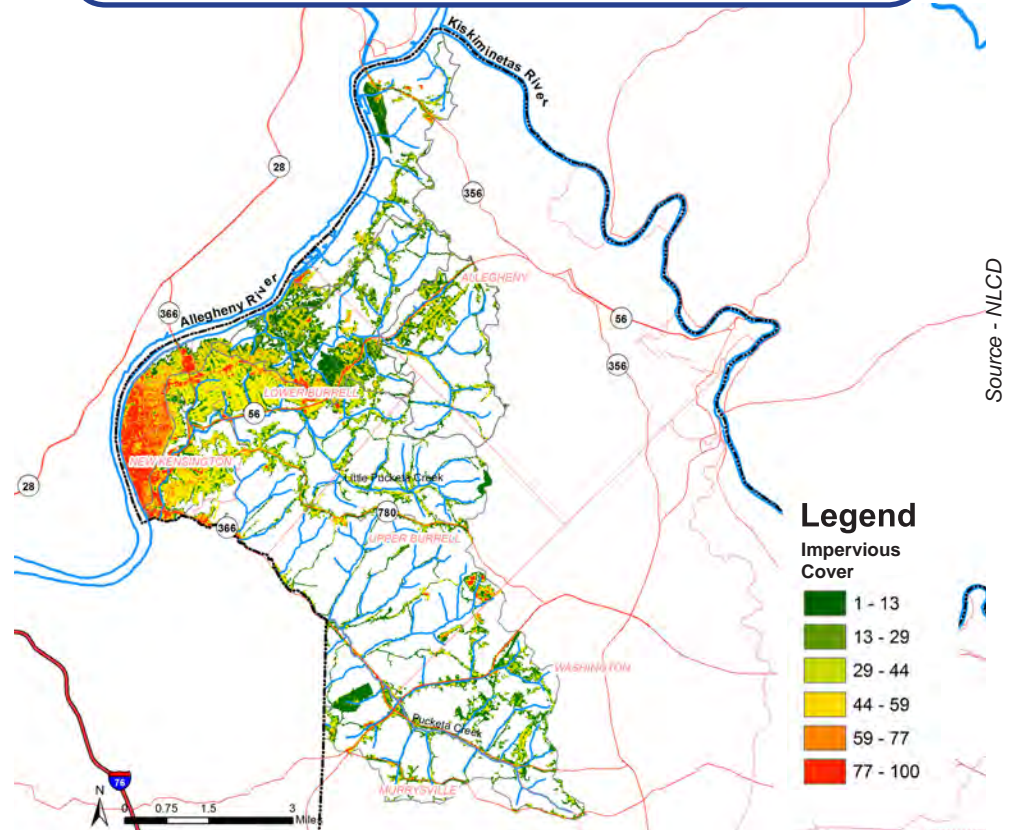

Valley High School - Pervious Parking Lot

Photo by Rob Cronauer







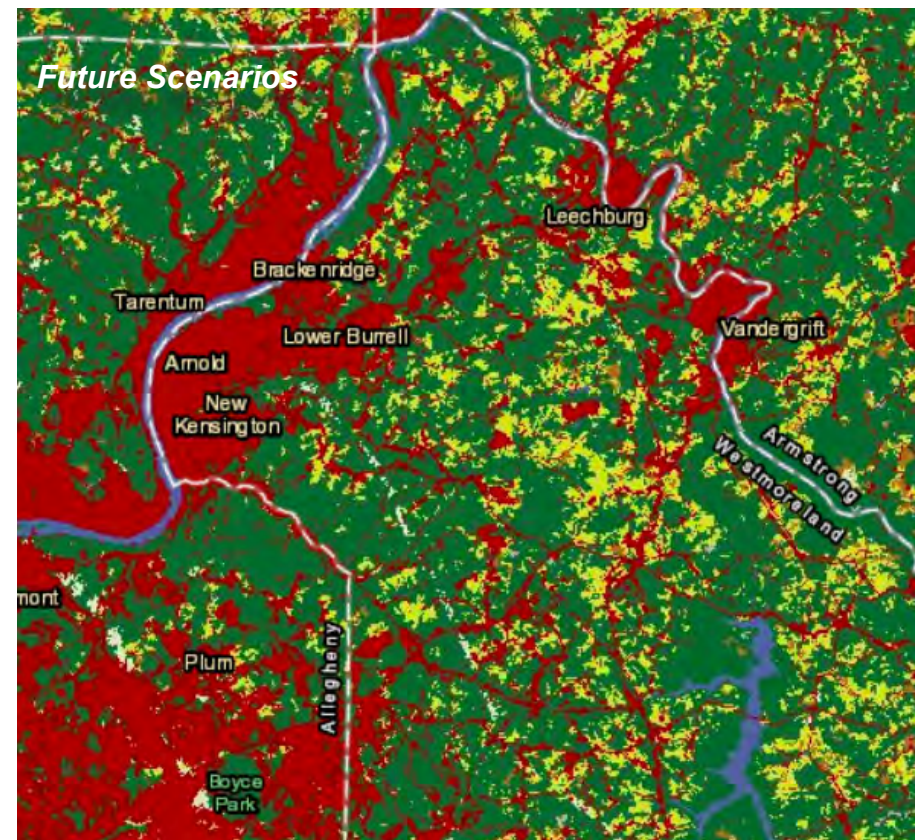
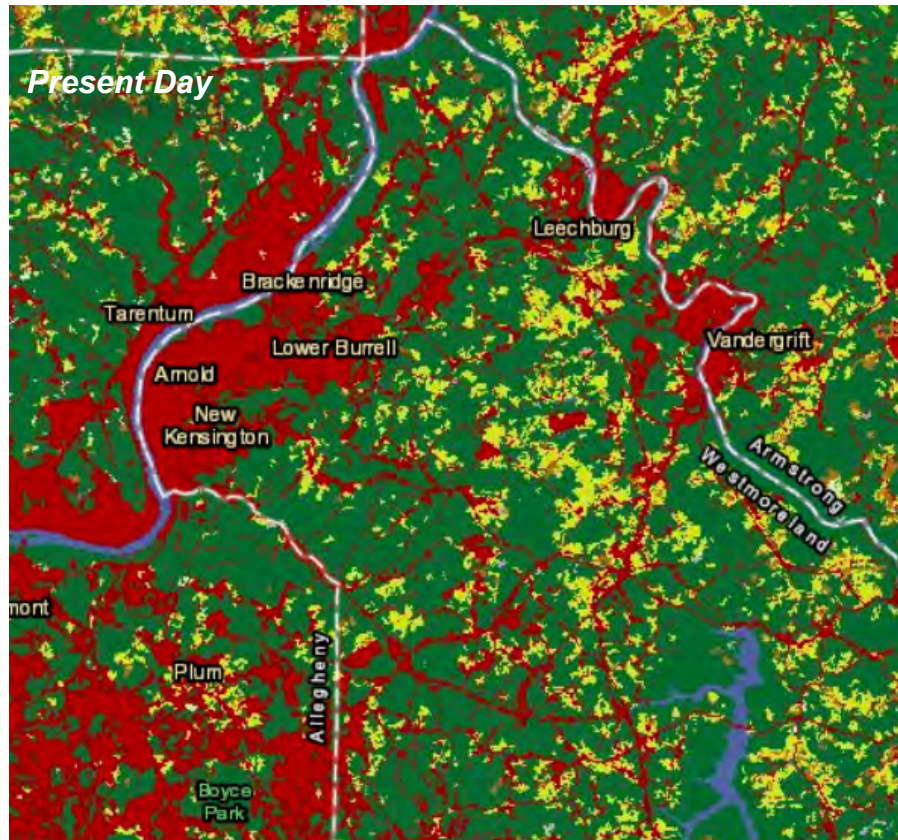





## FUTURE TRENDS IN THE PUCKETA CREEK - PLUM CREEK - ALLEGHENY RIVER WATERSHEDS

This watershed will likely see slight increases in development and accompanying slight reductions in forested and agricultural land. These land-use trends will likely add to stormwater runoff and



### Legend

National Land Cover Database

 Open Water	 Pasture/Hay
 Perennial Ice/Snow	 Cultivated Crops
 Developed	 Herbaceous and Woody Wetlands
 Barren Land (Rock/Sand/Clay)	
 Forests	
 Scrub/Shrub	
 Grassland/Herbaceous	

non-point pollution loadings. Carefully planning now to mitigate the effects of these changes will help to decrease flooding and pollution delivery downstream. The projections below are compiled from the ESRI GREEN INFRASTRUCTURE Online Mapping tool, developed in conjunction with the Clark Labs (<http://www.esri.com/about-esri/greeninfrastructure>).

### Specific predictions of change in land-use

Above, a visual comparison of land use in 2011 versus predicted land use in 2050 highlights the forecasted changes in landcover types. Predictions indicate only a slight increase in impervious surfaces. This analysis of land use change in the Conemaugh Area of Interest specifically estimates

- A 9% *INCREASE* in developed land,
- A 6% *DECREASE* in forest cover
- A 0.4% *DECREASE* in agricultural cropland

Source - ESRI



# JACOBS CREEK WATERSHED AREA OF INTEREST

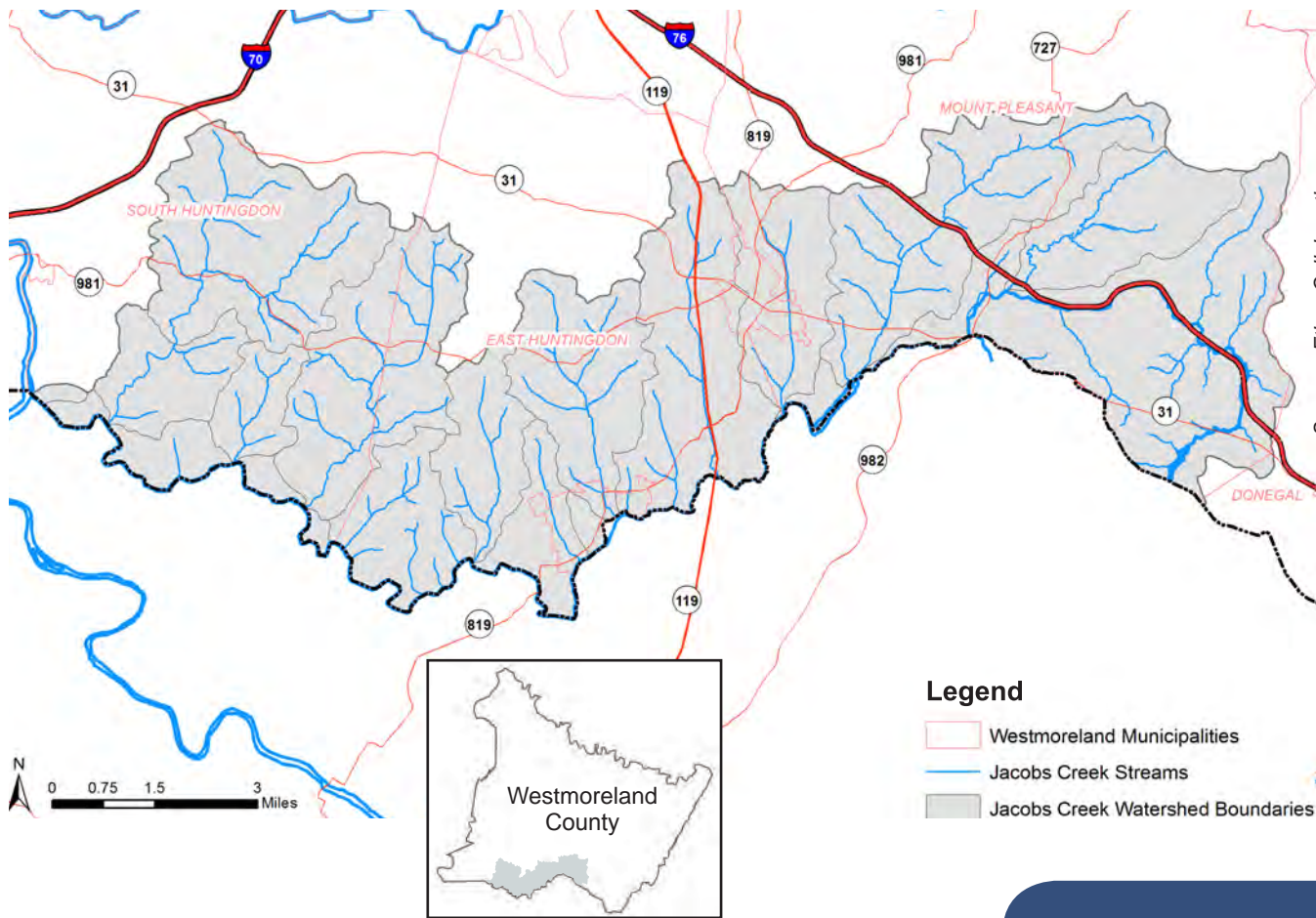

## Why is this watershed of particular interest?

This region has historically had major flooding issues which at one point led to the Jacobs Creek Flood Control Project. Even though this project was a success, flooding still occurs upstream in the watershed due to lack of regulation and stormwater detention.

## Assets in the Watershed

Both the Boroughs of Scottdale and Mount Pleasant have been very active in pursuing stormwater projects to alleviate flooding and improve water quality. The Jacobs Creek Watershed Association serves as the curator for a majority of these projects and serves as a major asset for the watershed.

## REGION OVERVIEW

The Jacobs Creek Area of Interest is approximately 71 mi<sup>2</sup>/45,510 acres and contains 150 miles of stream that drain south, forming Jacobs Creek, which eventually outlets into the Youghiogheny River. The landcover is primarily forested and agricultural land with pockets of density spreading out from the areas of Scottdale and Mount Pleasant. The watershed is split almost in the middle by Highway 119 which is a major transportation route running North and South through the county. There are also several state roads running through the watershed such as, Route 819, Route 31, Route 981, and Route 982. A majority of these routes transect between rural farmland to small historic towns and suburbs.

## WATERSHED SNAPSHOT

- **Area:** 71 mi<sup>2</sup>/45,510 acres
- **Water Quality:** Impaired for aquatic life due to abandoned mine drainage, siltation, nutrients, metals, and impoundments.
- **Characterization:** This area of interest consists largely forested and agricultural land with pockets of developed land in the center of the watershed.
- **Scottdale Borough, the most densely populated region of this watershed, is currently working to reduce pollution as part of an MS4 Pollution Reduction Plan.**



## Landcover / Landuse

The landcover for the watershed is mix between a majority of deciduous forest and agricultural land consisting of pasture and cultivated crops. The concentrations of medium density developed land surrounded by low intensity development represent the areas of Scottsdale and Mount Pleasant and their immediate suburbs.

Landcover data is based on the 2011 National Land Cover Dataset, created by the Multi-resolution Land Characteristics Consortium (MRLC). Refer to [www.mrlc.gov](http://www.mrlc.gov) for methodology.

## Jacobs Creek Area of Interest Landcover Classification

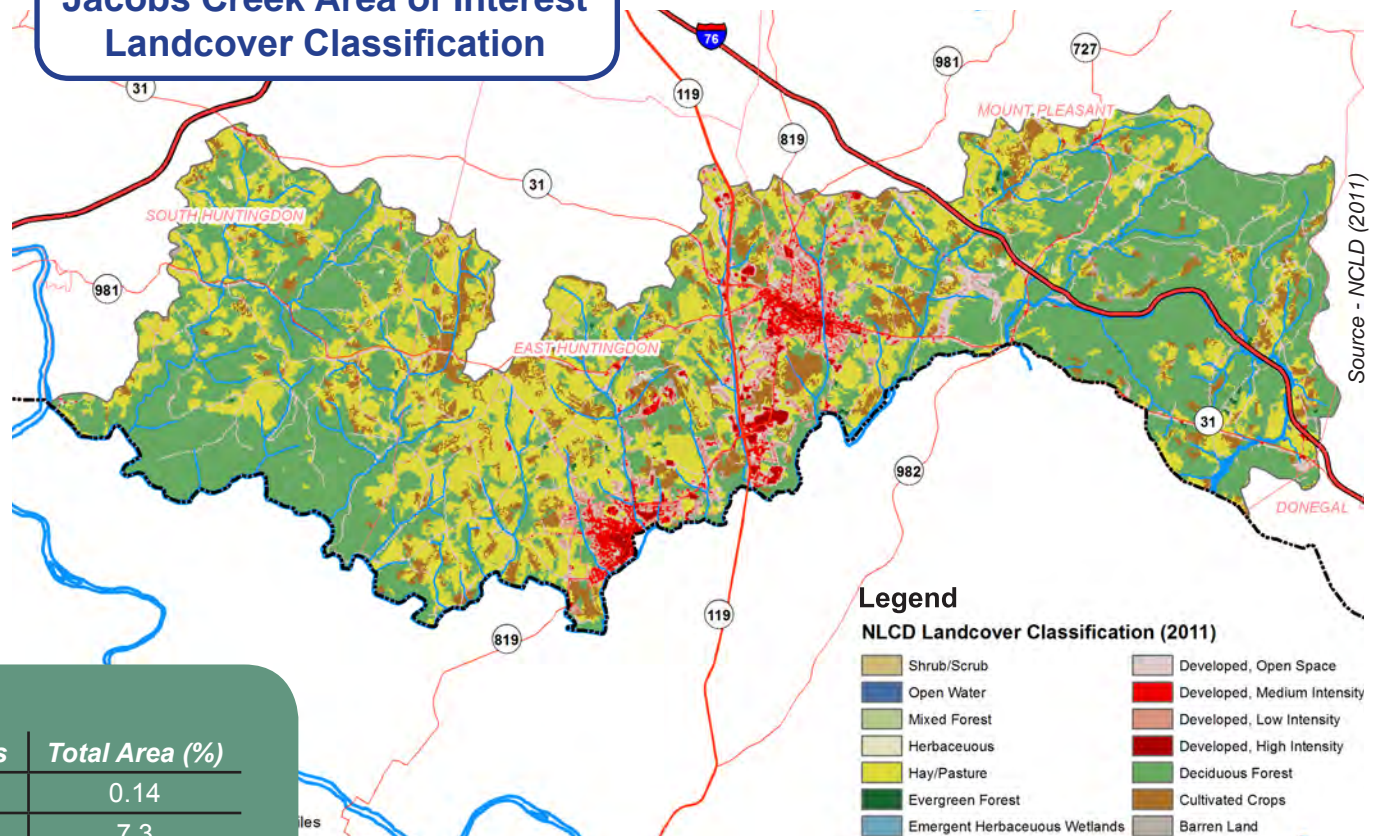

Landcover Class	Acres	Total Area (%)
Open Water	66	0.14
Developed, Open Space	3315	7.3
Developed, Low Intensity	2006	4.4
Developed, Medium Intensity	1092	2.4
Developed, High Intensity	303	0.7
Barren Land	210	0.5
Deciduous Forest	20553	45.2
Evergreen Forest	65	0.14
Mixed Forest	17	0.04
Shrub/Scrub	7	0.02
Herbaceous	71	0.16
Hay/Pasture	14109	31
Cultivated Crops	3697	8.1



Bridgeport Dam Reservoir

Photo - Jacobs Creek Watershed Association



## CURRENT WATER QUALITY IN THE JACOBS CREEK WATERSHED AREA OF INTEREST

### Non-point source pollution

In all, the Pennsylvania Department of Environmental Protection identified 113 stream miles as “attaining” their designated use of supporting aquatic life, 37 stream miles as “non-attaining” for that designated use, and the remaining are unclassified. Identified impairments include metals/ph from abandoned mine drainage, siltation from agriculture and urban/ road runoff. These upstream impairments in the subwatersheds filter down to the main stem of Jacobs Creek causing several segments to be impaired for sediment from various sources.

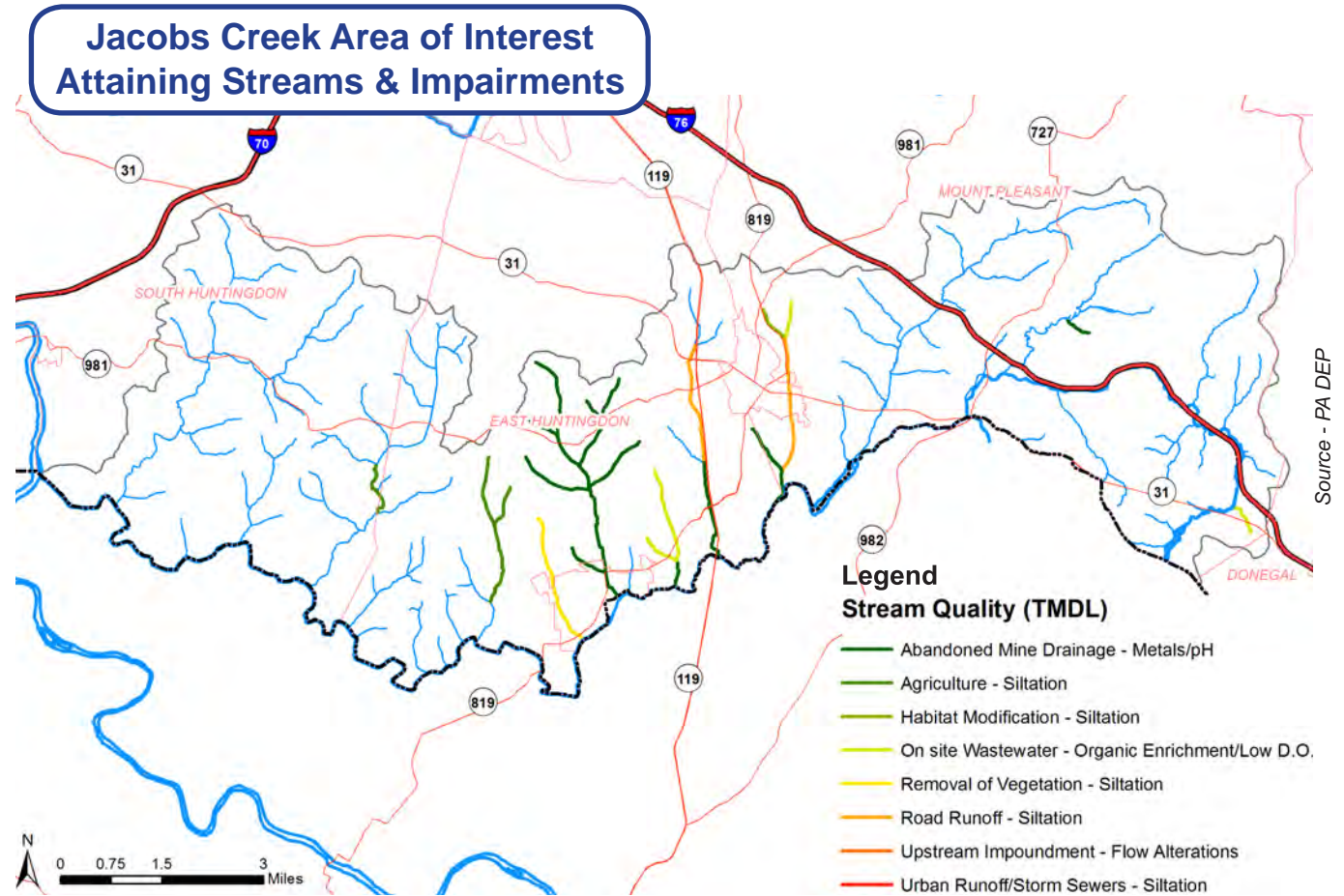

Jacobs Creek - Stream Stabilization

Photo by Mark Jackson



Jacobs Creek

Photo by Stephen Simpson



## WATER QUALITY AND WATER QUANTITY ARE INEXTRICABLY LINKED IN THE JACOBS CREEK AREA OF INTEREST

Here, a watershed map shows the concentration of impervious surface in the areas of Scottsdale and then stretching north east to Mount Pleasant. These two areas of development also straddle the high concentration of impervious surface that is Route 119 and its businesses. You will also notice the impervious surfaces that are associated with the state road corridors that run through the watershed. These surfaces play a major role in pollutant transfer in these areas due to a lack of regional stormwater infrastructure. Several municipality in the watershed also address the issue of stormwater management differently which can result in watershed related issues.

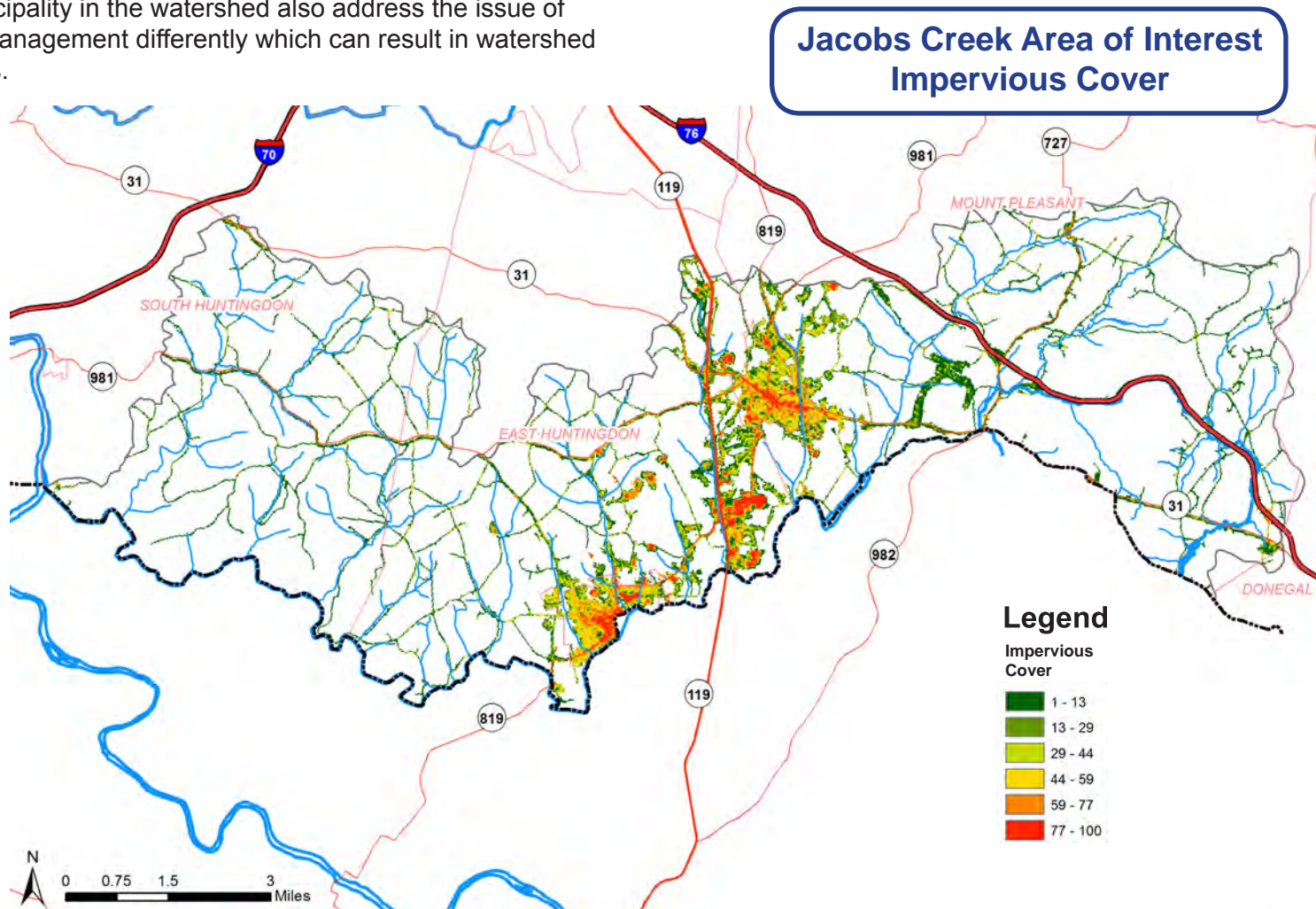







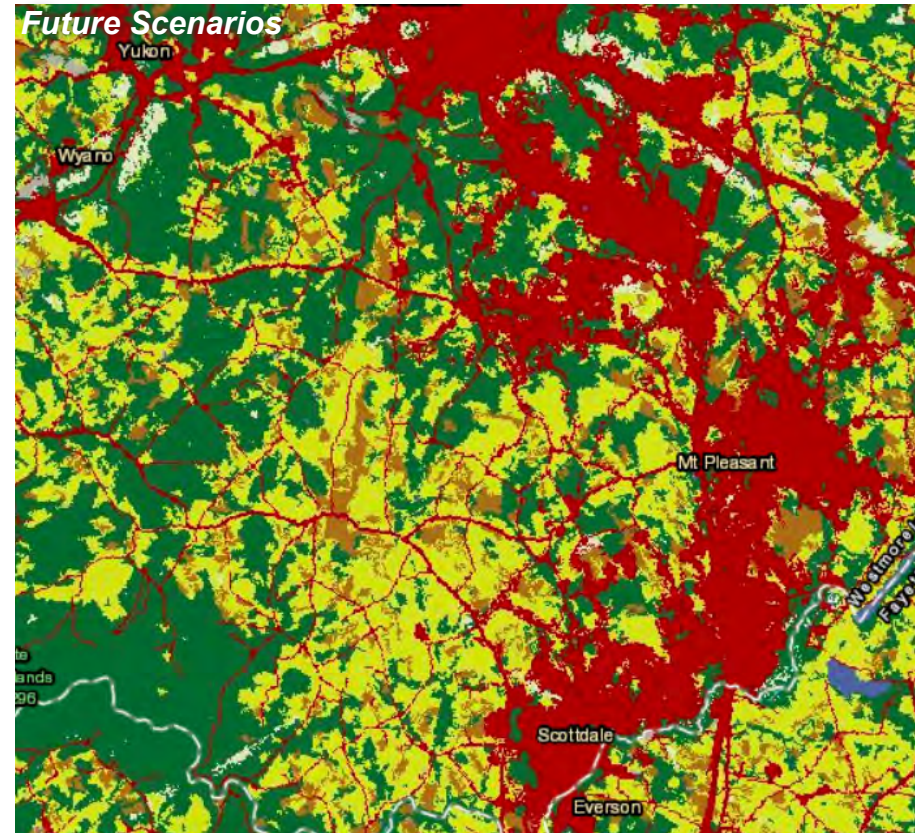
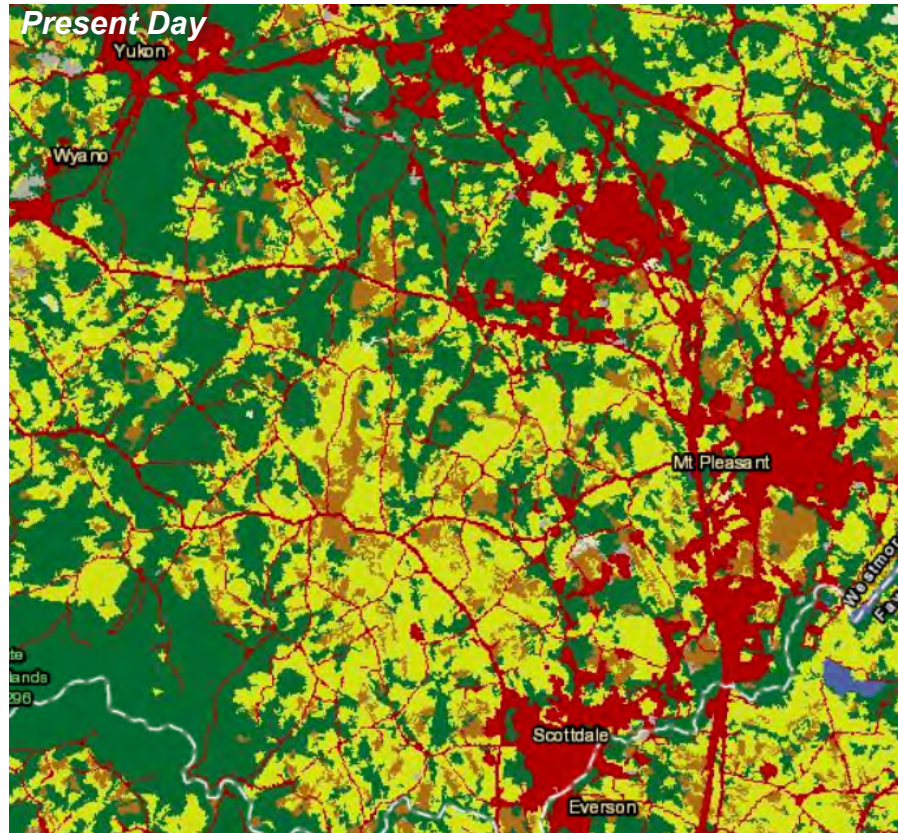



## FUTURE TRENDS IN THE JACOBS CREEK WATERSHED

This watershed will likely see significant increases in development and accompanying reductions in forested and agricultural land. These land-use trends will likely add to stormwater runoff and non-point pollution loadings. Carefully planning now to mitigate the



### Legend

National Land Cover Database

	Open Water		Pasture/Hay
	Perennial Ice/Snow		Cultivated Crops
	Developed		Herbaceous and Woody Wetlands
	Barren Land (Rock/Sand/Clay)		
	Forests		
	Scrub/Shrub		
	Grassland/Herbaceous		

effects of these changes will help to decrease flooding and pollution delivery downstream. The projections below are compiled from the ESRI GREEN INFRASTRUCTURE Online Mapping tool, developed in conjunction with the Clark Labs (<http://www.esri.com/about-esri/greeninfrastructure>).

### Specific predictions of change in land-use

Above, a visual comparison of land use in 2011 versus predicted land use in 2050 highlights the forecasted changes in landcover types. Predictions indicate only a slight increase in impervious surfaces. This analysis of land use change in the Conemaugh Area of Interest specifically estimates

- A 37% *INCREASE* in developed land,
- A 7% *DECREASE* in forest cover
- A 10% *DECREASE* in agricultural cropland

Source - ESRI



# YOUGHIOGHENY RIVER WATERSHED AREA OF INTEREST

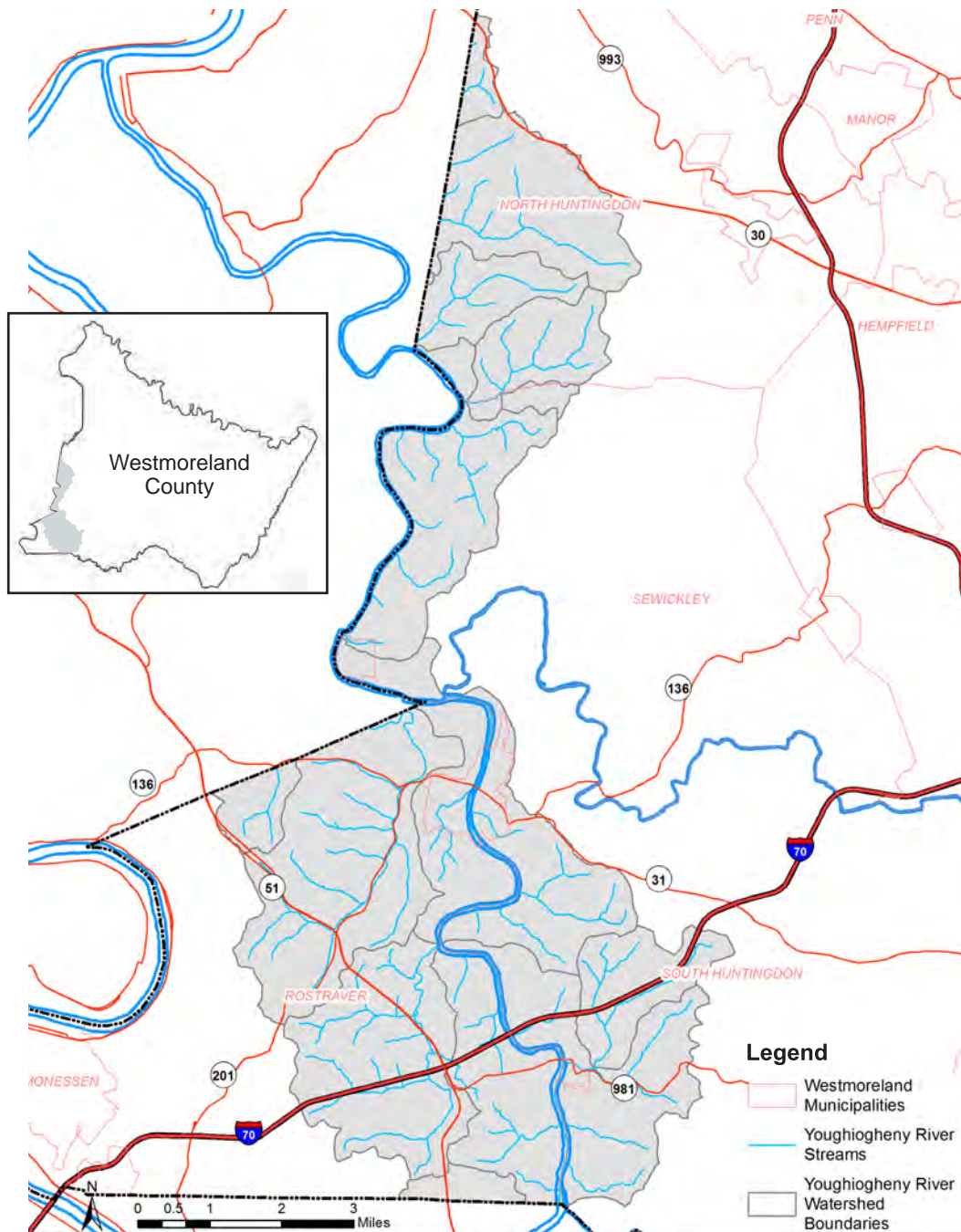

Source - Ethos Collaborative

## REGION OVERVIEW

The Youghiogheny River Area of Interest is approximately 47 mi<sup>2</sup>/30,210 acres and contains 119 miles of streams that drain into the Youghiogheny River. Landcover in this watershed is predominantly deciduous forest and hay/pasture, with a concentration of urbanized land and associated impervious surface around the towns of Rostraver, West Newton, and North Huntingdon. The watershed also contains several major roadways including, the PA Turnpike, Route 51, and Route 30 at the very northern border.

### Why is this watershed of particular interest?

This region was identified due to the rapidly developing areas of Rostraver and North Huntingdon Townships. These areas have seen considerable increases in development over the past several decades as people began to spread from Allegheny County and the Pittsburgh region. The two areas are suited along major transportation corridors and were surrounded by relatively cheap open land, which led to significant increase in both large commercial and residential complexes which have the ability to produce tremendous amounts of stormwater flow.

### Assets in the Watershed

The Youghiogheny River flows through several communities designated as MS4 which have been working toward meeting the program requirements by establishing pollutant reduction

### WATERSHED SNAPSHOT

- **Area:** 47.2 mi<sup>2</sup>/30,210 acres
- **Water Quality:** Impaired for aquatic life due to abandoned mine drainage, siltation, nutrients, metals,
- **Characterization:** This area of interest is largely forested and agriculture, with pockets of developed land spread throughout the watershed.
- **Rostraver Township, the most densely populated region of this watershed.**

plans. The river is a well-used recreation destination for boating and fishing and for bicycling and hiking along the scenic river trail that runs its length.

### Landcover / Landuse

Landcover in this watershed is predominantly deciduous forest and hay/pasture, with a concentration of urbanized land and associated impervious surface around the towns of Rostraver, West Newton, and North Huntingdon. These areas were historically agricultural with small towns existing along the river and major highway corridors. As sprawl from the Pittsburgh region headed east, these agricultural lands with easy access to highways became developed into large housing complexes and strip malls, both which are associated with high impervious percentages and ultimately increase stormwater runoff and contributes to water pollutant and migration.

Landcover data is based on the 2011 National Land Cover Dataset, created by the Multi-resolution Land Characteristics Consortium (MRLC). Refer to [www.mrlc.gov](http://www.mrlc.gov) for methodology.

Landcover Class	Acres	Total Area (%)
Open Water	579	1.9
Developed- Open Space	3,555	11.8
Developed- Low Intensity	3,531	11.7
Developed- Medium Intensity	1,328	4.4
Developed- High Intensity	298	1
Barren Land	154	0.5
Deciduous Forest	12,758	42.2
Evergreen Forest	17	0.06
Mixed Forest	17	0.06
Shrub/Scrub	4	0.01
Herbaceous	48	0.16
Hay/Pasture	7,192	23.8
Cultivated Crops	728	2.4

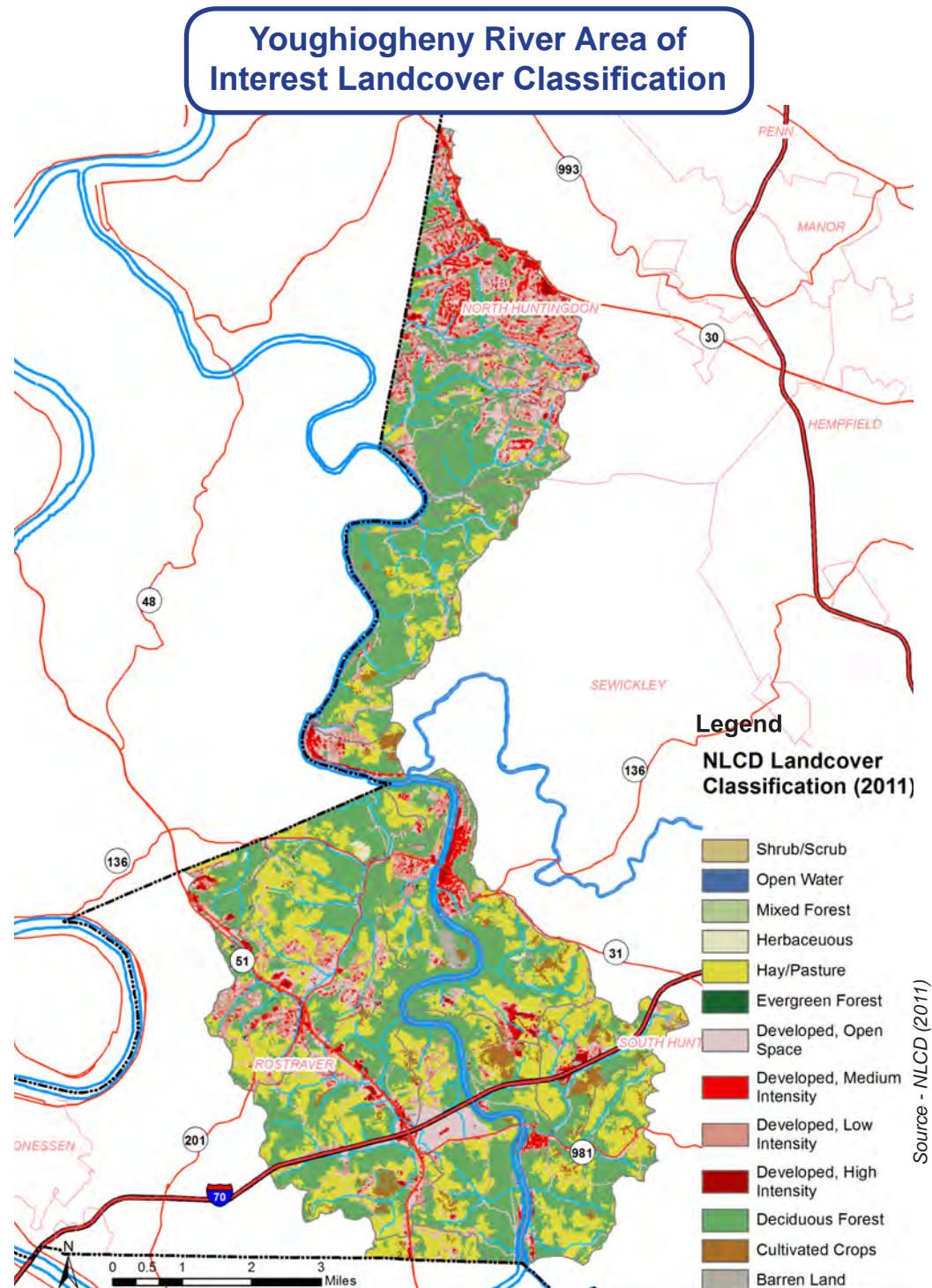



## Youghiogheny River Area of Interest Attaining & Impaired Streams

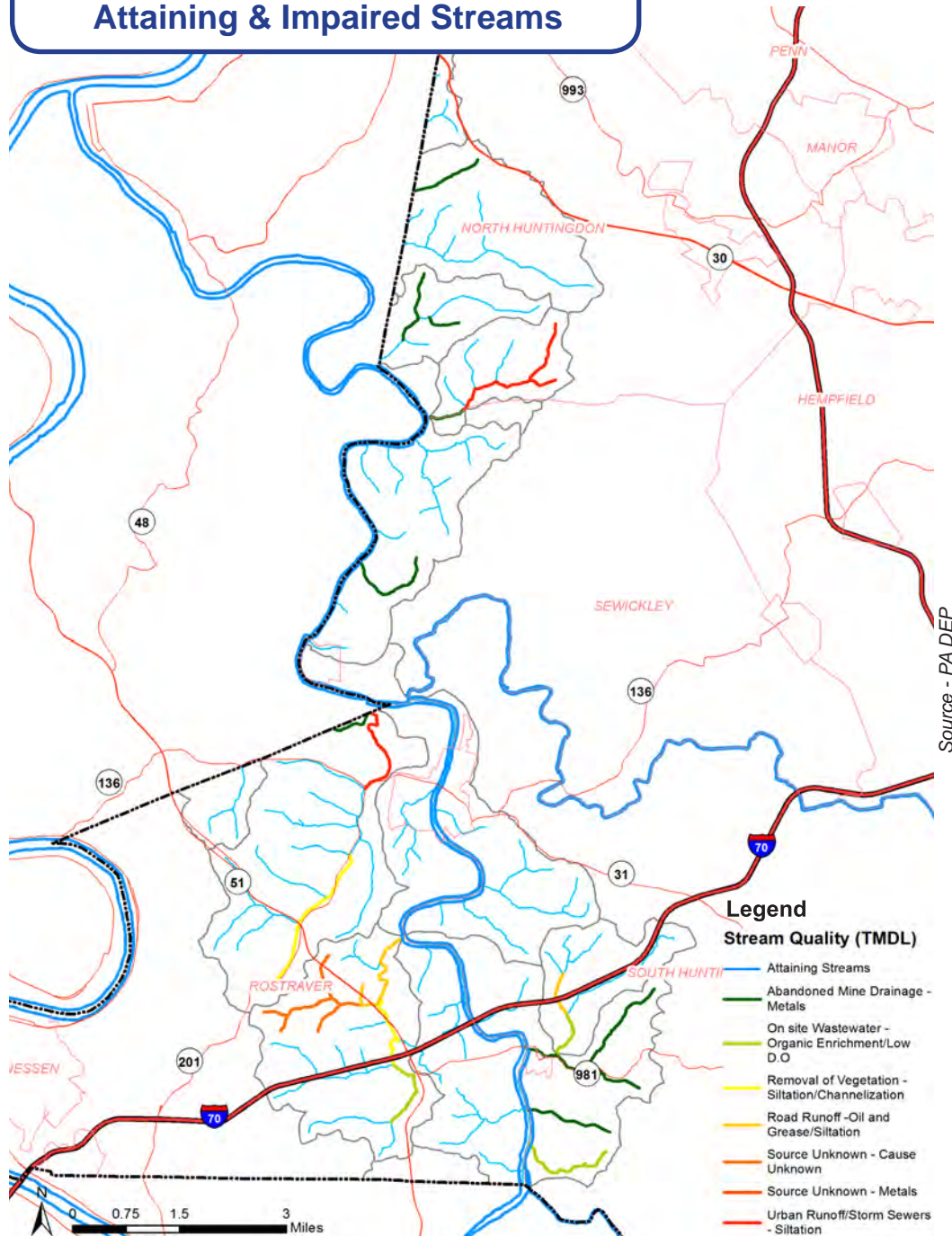

## CURRENT WATER QUALITY IN THE YOUGHIOGHENY RIVER WATERSHED AREA OF INTEREST

### Non-point source pollution

In all, the Pennsylvania Department of Environmental Protection identified 88 stream miles as “attaining” their designated use of supporting aquatic life, 31 stream miles as “non-attaining” for that designated use, and the remaining are unclassified. Identified impairments include abandoned mine drainage, on site wastewater, organic enrichment, siltation, and oil and grease. These are considered non-point sources, originating not from one identifiable point but instead from diffuse sources across the landscape.



Youghiogheny River at West Newton

Photo by Mark Jackson



## Youghiogheny River Area of Interest Impervious Cover

### WATER QUALITY AND WATER QUANTITY ARE INEXTRICABLY LINKED IN THE YOUGHIOGHENY RIVER WATERSHED AREA OF INTEREST

The highest concentrations of impervious surfaces in the watershed exist along the major highway corridors and at a few points along the Youghiogheny River. From there the development radiates outward in the form of medium to low intensity development, which can range between 13% - 77% impervious surface. This wide range of impervious surface intensities can produce both flooding and water pollution problems. These high concentration flows can transport pollutants from parking lots as well as pollution from sediment due to the erosive forces of the stormwater that is produced by these large expanses of impervious surface.



Bridge over the Youghiogheny River at its confluence with Jacobs Creek

Photo - Jacobs Creek Watershed Association

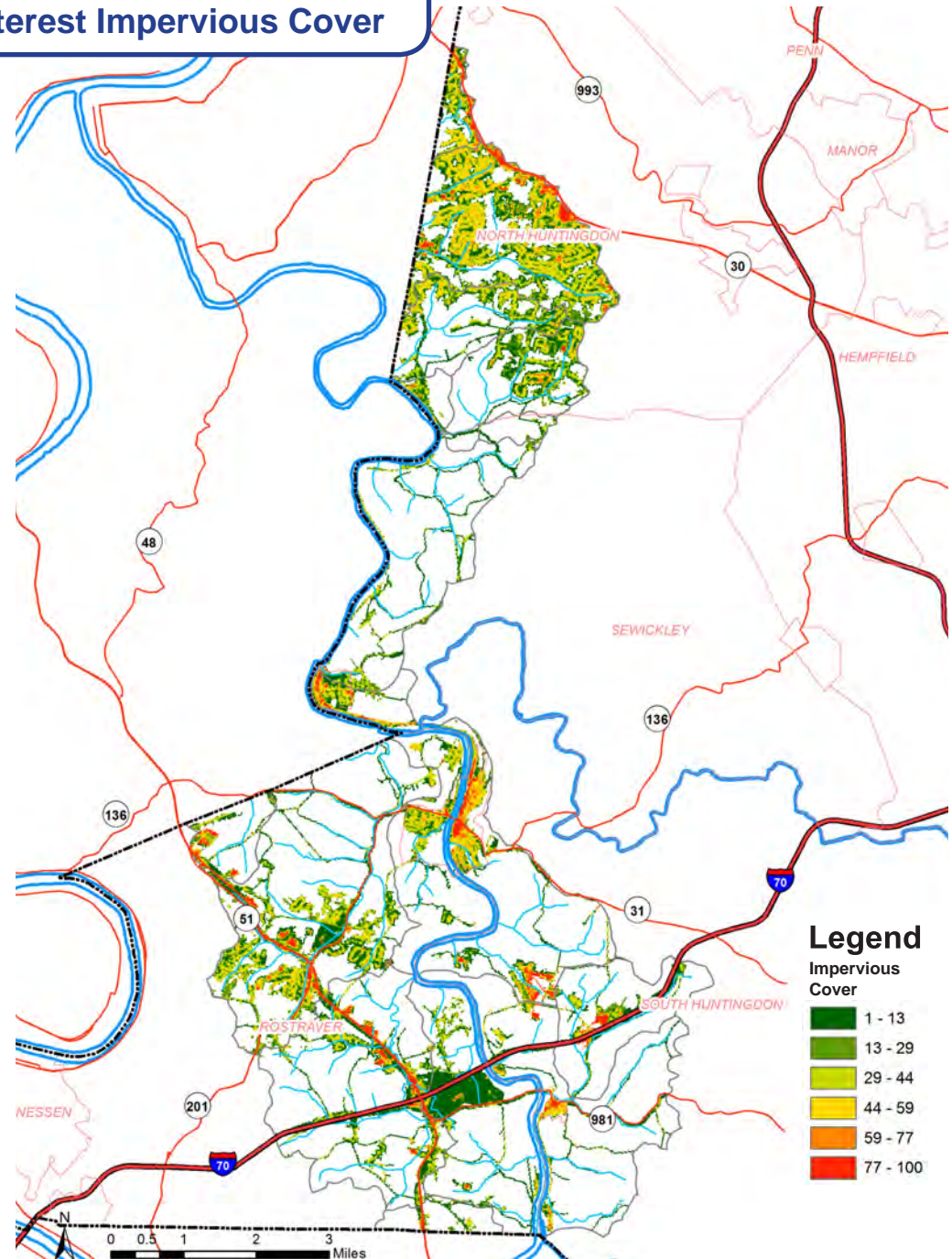

Source - NLCD



## FUTURE TRENDS IN THE YOUGHIOGHENY RIVER WATERSHED

This watershed will likely see significant increases in development and accompanying significant reductions in forested and agricultural land. These land-use trends will likely add to stormwater runoff and

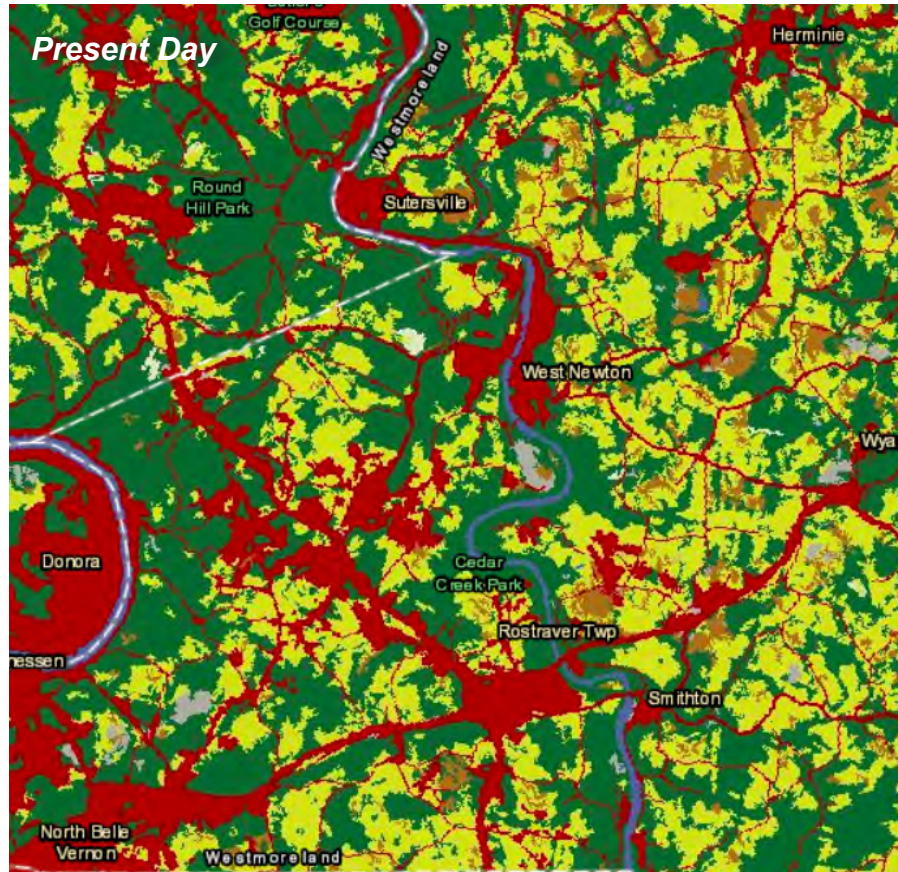

### Legend

National Land Cover Database

	Open Water		Pasture/Hay
	Perennial Ice/Snow		Cultivated Crops
	Developed		Herbaceous and Woody Wetlands
	Barren Land (Rock/Sand/Clay)		
	Forests		
	Scrub/Shrub		
	Grassland/Herbaceous		

non-point pollution loadings. Carefully planning now to mitigate the effects of these changes will help to decrease flooding and pollution delivery downstream. The projections below are compiled from the ESRI GREEN INFRASTRUCTURE Online Mapping tool, developed in conjunction with the Clark Labs (<http://www.esri.com/about-esri/greeninfrastructure>).

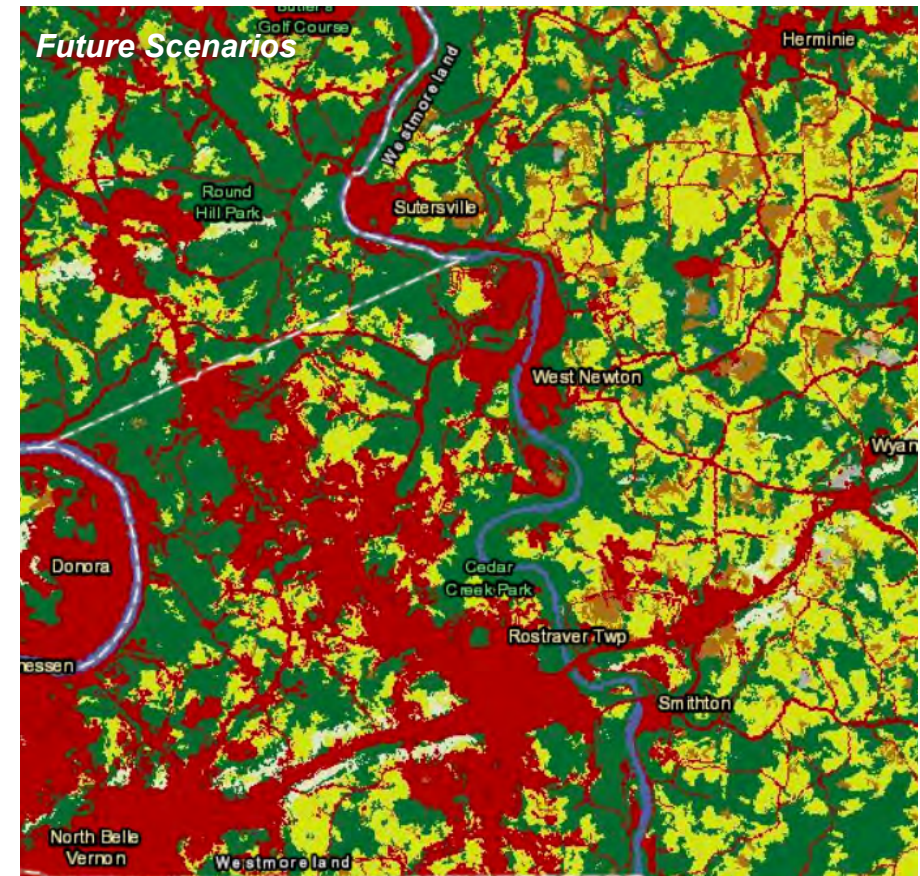

### Specific predictions of change in land-use

Above, a visual comparison of land use in 2011 versus predicted land use in 2050 highlights the forecasted changes in landcover types. Predictions indicate only a slight increase in impervious surfaces. This analysis of land use change in the Conemaugh Area of Interest specifically estimates

- A 32% *INCREASE* in developed land,
- A 11% *DECREASE* in forest cover
- A 16% *DECREASE* in agricultural cropland

Source - ESRI



# INDIAN CREEK WATERSHED AREA OF INTEREST

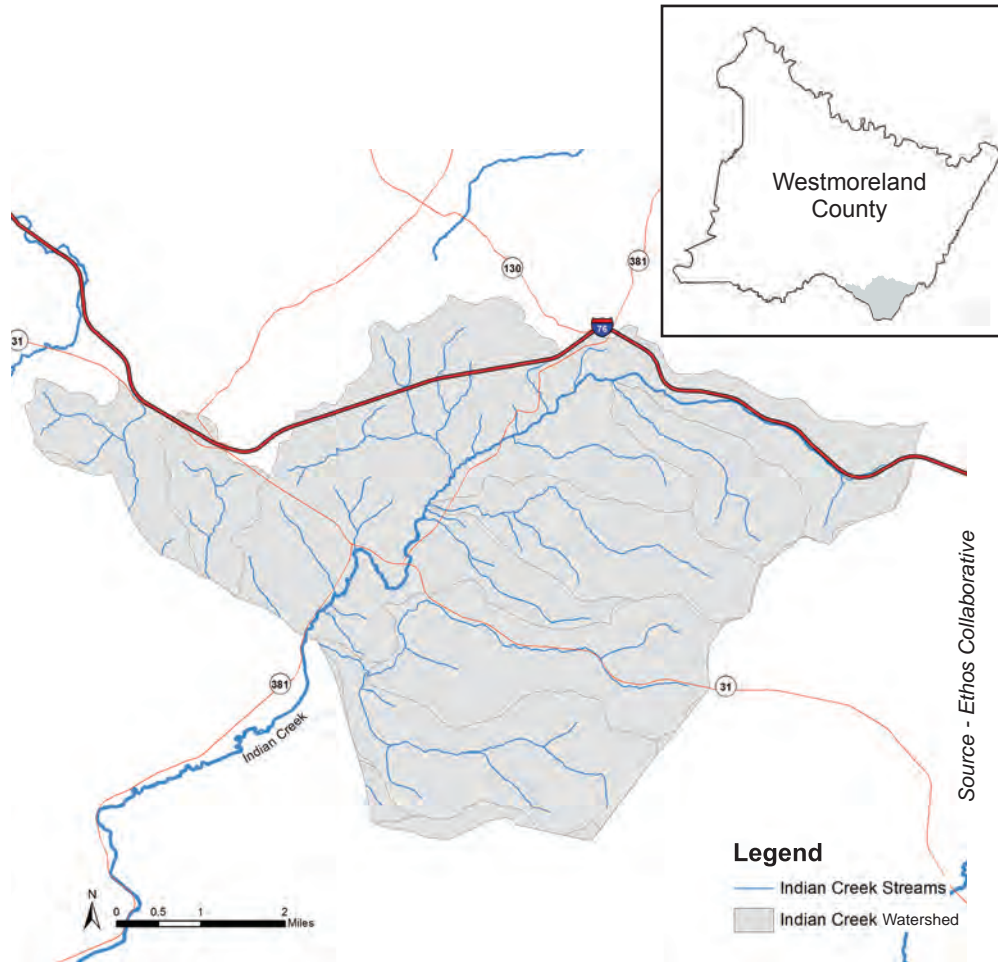

## REGION OVERVIEW

The Indian Creek Area of Interest is approximately 35 mi<sup>2</sup>/22,400 acres in size. Landcover in the watershed is primarily forest with over 80% of the area being forested. This watershed does not have the traditional development pressure as some of the other studied, however its location along the Pa Turnpike and several other state roads has allowed it to be a particularly popular spot for both natural recreation and resource extraction. This can produce a very interesting balancing act between allowing for resource extraction while preserving the natural state of the watershed which has allowed it to become a regional destination for outdoor recreation and enjoyment.

## Why is this watershed of particular interest?

This region was identified to be studied due to the ongoing watershed restoration work being done by the Mountain Watershed Association, which is a non profit aimed at protecting, preserving, and restoring the Indian Creek watershed. The area is also of significant regional value as a outdoor recreation and resort destination. This watershed houses the two largest mountain resorts in the geographic region, which brings visitors from several surrounding counties and states to enjoy the beautiful scenery of this watershed.

## Assets in the Watershed

The Mountain Watershed Association pursues on-the-ground restoration of past environmental damage, such as coal and shale gas extraction impacts. The organization is focused on holding polluters and environmental regulators accountable in order to protect both the local communities and the environment. This typically comes in the form of conducting site investigation, performing water quality sampling, and if necessary, taking legal actions to ensure compliance with state and federal laws. The group is also currently working on developing the Youghiogheny River Water Trail and the Indian Creek Valley Trail.

## WATERSHED SNAPSHOT

- **Area:** 35 mi<sup>2</sup>/22,400 acres
- **Water Quality:** *Impaired due to abandoned mine water discharges; threatened by potential resource extraction impacts and land development impacts*
- **Characterization:** *This area of interest consists largely of forested and agricultural land with a pocket of developed land in the north west of the watershed.*
- **Donegal area** is the home to several local outdoor attractions such as Seven Springs Mountain Resort and Hidden Valley Resort.



### Landcover / Landuse

Landcover in this watershed is predominantly deciduous forest, with over 80% being forested. The watershed also does not contain any significant amount of developed area, except for the Donegal area. The total developed percentage of the watershed is less than 10%, with virtually all development following one of the state route corridors.

Landcover data is based on the 2011 National Land Cover Dataset, created by the Multi-resolution Land Characteristics Consortium (MRLC). Refer to [www.mrlc.gov](http://www.mrlc.gov) for methodology.

Landcover Class	Acres	Total Area (%)
Open Water	10	0.05
Developed, Open Space	1351	6.09
Developed, Low Intensity	322	1.45
Developed, Medium Intensity	214	0.97
Developed, High Intensity	41	0.18
Barren Land	46	0.21
Deciduous Forest	18016	81.23
Evergreen Forest	69	0.31
Mixed Forest	25	0.11
Herbaceous	18	0.08
Hay/Pasture	1818	8.20
Cultivated Crops	246	1.11
Woody Wetlands	0	0.00
Emergent Herbaceous Wetlands	2	0.01

### Indian Creek Area of Interest Landcover Classification

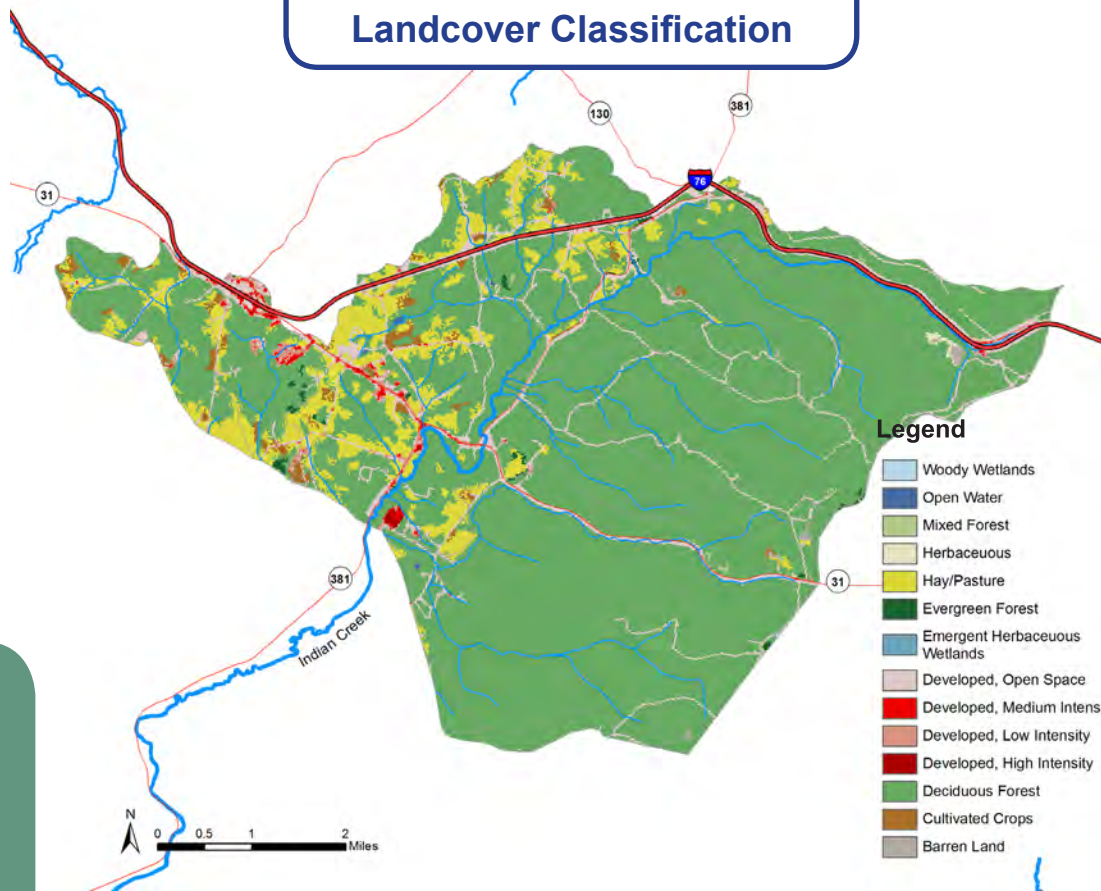

Source - NLCD (2011)

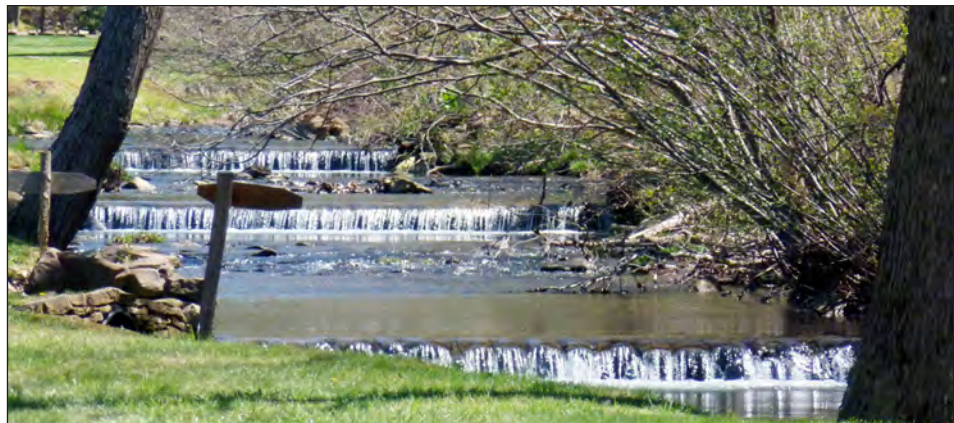
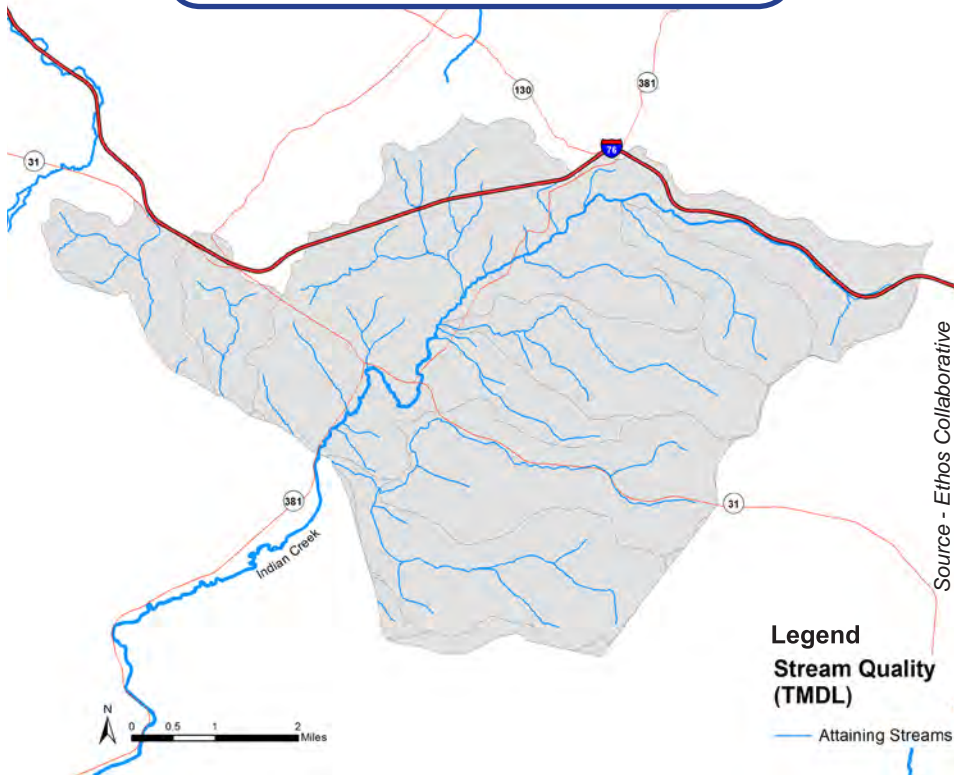

Photo by Stephen Simpson

Indian Creek



## Indian Creek Area of Interest Attaining & Impaired Streams



## CURRENT WATER QUALITY IN THE INDIAN CREEK WATERSHED AREA OF INTEREST

### Non-point source pollution

In all, the Pennsylvania Department of Environmental Protection identified the entire watershed as “attaining” for their designated uses. The lack of development and the expanse of forested land helps to contribute to the high level of water quality in the watershed. This high level of water quality has let to the watershed being home to some of the regions most popular and successful outdoor attraction, from skiing to white water rafting. This historic use as a recreational destination mixed with the recent influx of shale gas development in the area has raised concerns for several environmental groups, as they are concerned their regions most precious resource, water, becoming polluted by the gas extraction process.



Photo by Mark Jackson

A riparian buffer along an Indian Creek tributary



Photo - Mountain Watershed Association

Indian Creek Trail - Mountain Watershed Tour



## WATER QUALITY AND WATER QUANTITY ARE INEXTRICABLY LINKED IN THE INDIAN CREEK WATERSHED AREA OF INTEREST

As water accumulates and moves overland on impervious surfaces, it picks up pollutants from the surface of the landscape and delivers it to receiving waters. Development, particularly that which increases impervious surfaces on the landscape, increases the overland flow of water during storms and decreases infiltration to groundwater. Increased stormwater also increases the erosive force of overland flow, increasing sediment load and delivering it to downstream receiving waters. Here, a watershed map shows the concentration of impervious surface in the area of Donegal and around roads.

As stormwater runoff increases, so does the water's capacity to carry sediment and nutrients such as Nitrogen and Phosphorus. Stormwater may drop sediment and pollutants when the flow/energy of the water decreases. Both the sediment and the pollution are a threat to water. Accumulated nutrients can lead to harmful algae blooms, which may affect wildlife and water quality in the reservoir. The sediment accumulation represents the erosion, and loss, of valuable soil from upstream landscapes.

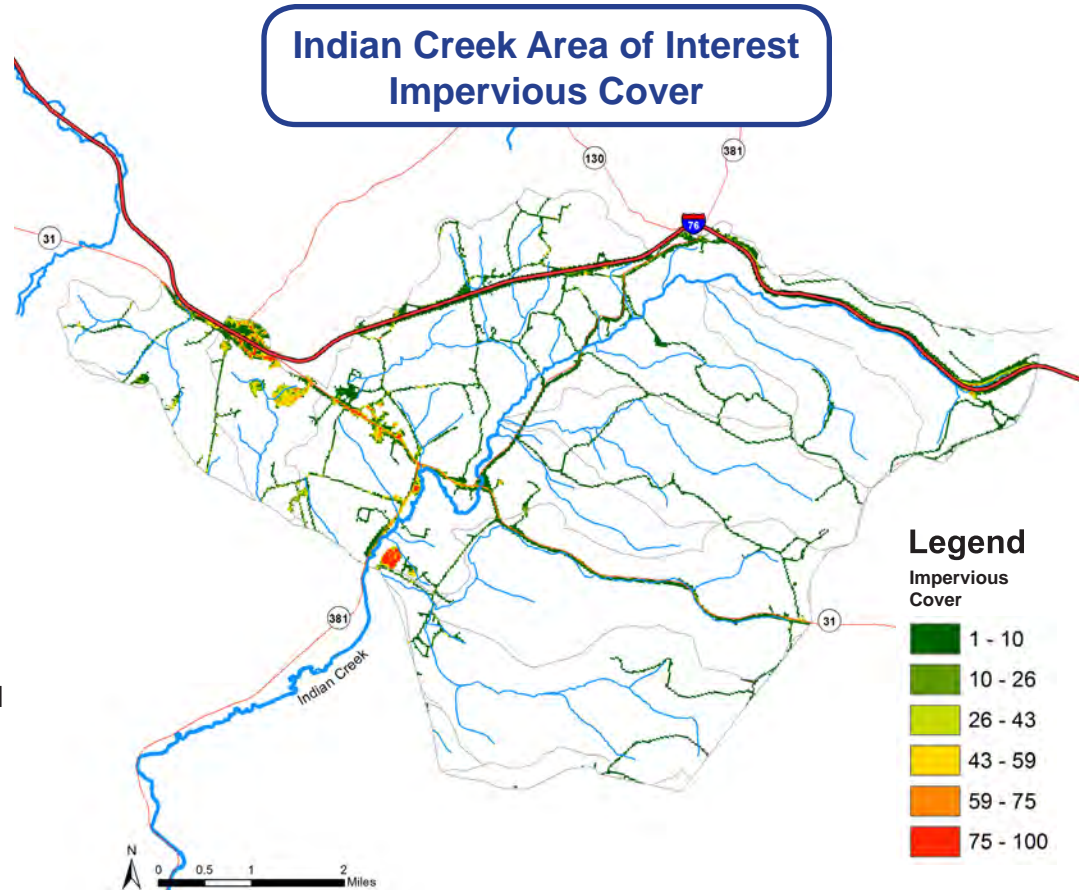

Source - NLCD (2011)



Marcellus Gas Well Pad

Photo by Mark Jackson

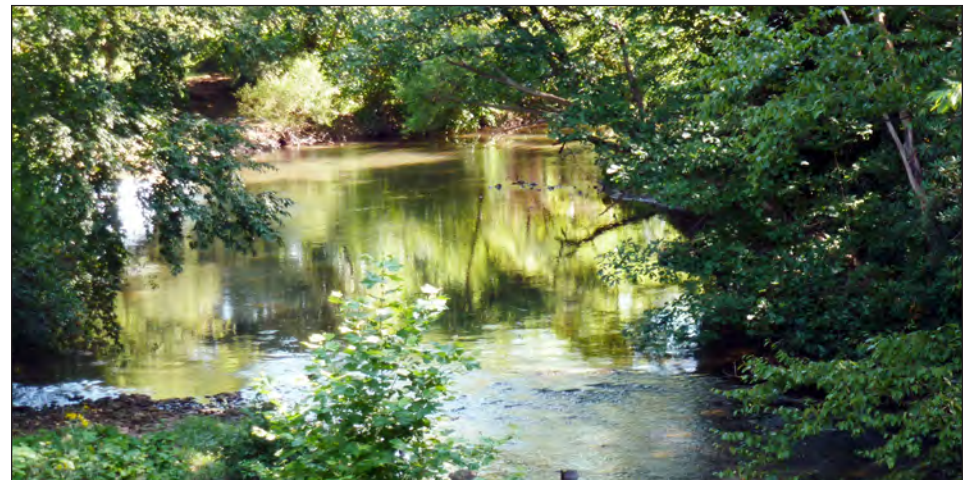

Indian Creek

Photo by Stephen Simpson



## FUTURE TRENDS IN THE INDIAN CREEK WATERSHED AREA OF INTEREST

This watershed will likely see slight increases in development and accompanying slight reductions in forested land. These land-use trends will likely add to stormwater runoff and non-point pollution loadings. Carefully planning now to mitigate the effects of these



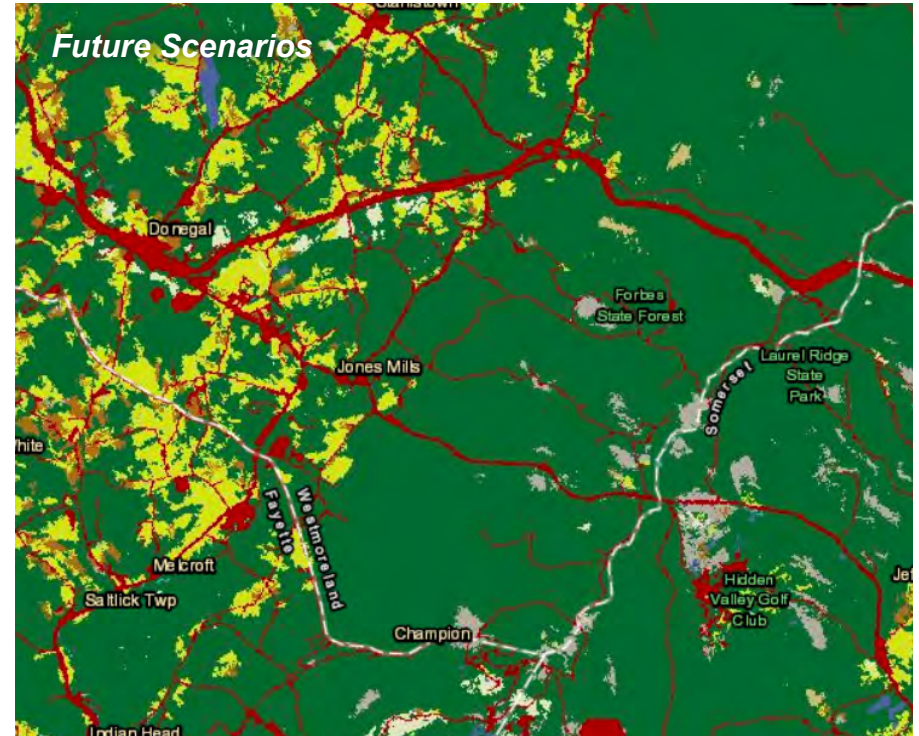
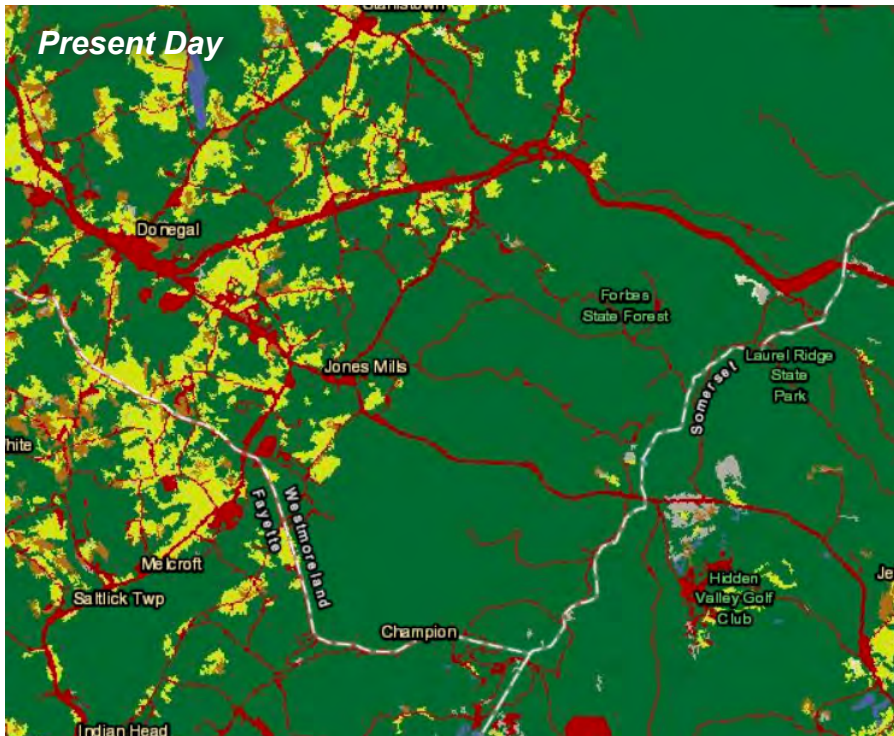







changes will help to decrease flooding and pollution delivery downstream. The projections below are compiled from the ESRI GREEN INFRASTRUCTURE Online Mapping tool, developed in conjunction with the Clark Labs (<http://www.esri.com/about-esri/greeninfrastructure>).



Source - ESRI

### Legend

National Land Cover Database

 Open Water	 Pasture/Hay
 Perennial Ice/Snow	 Cultivated Crops
 Developed	 Herbaceous and Woody Wetlands
 Barren Land (Rock/Sand/Clay)	
 Forests	
 Scrub/Shrub	
 Grassland/Herbaceous	

### Specific predictions of change in land-use

Above, a visual comparison of land use in 2011 versus predicted land use in 2050 highlights the forecasted changes in landcover types. Predictions indicate only a slight increase in impervious surfaces. This analysis of land use change in the Conemaugh Area of Interest specifically estimates

- A 9% *INCREASE* in developed land,
- A 6% *DECREASE* in forest cover
- A 0.4% *DECREASE* in agricultural cropland



## CONCEPTUAL PROJECTS AND COSTS

In Chapter 4, IMPACTS, we discussed numerous stormwater issues identified across the county and our watersheds, which generally fall into one of seven categories, or any combination of the seven:

- Flooding
- Inadequate infrastructure
- Water pollution
- Accelerated erosion
- Habitat loss or damage
- Sedimentation and
- Other.

In the same chapter, the **Stormwater Issues** map shows clusters of stormwater complaints and hotspots in the county where multiple complaints and combined issues have been identified. A second map, Conceptual Stormwater Projects, shown below, identifies potential project locations and conceptual projects within each watershed to address these stormwater issues and the pollutants identified in the modeling and reduce the incidence of further degradation of our water resources.

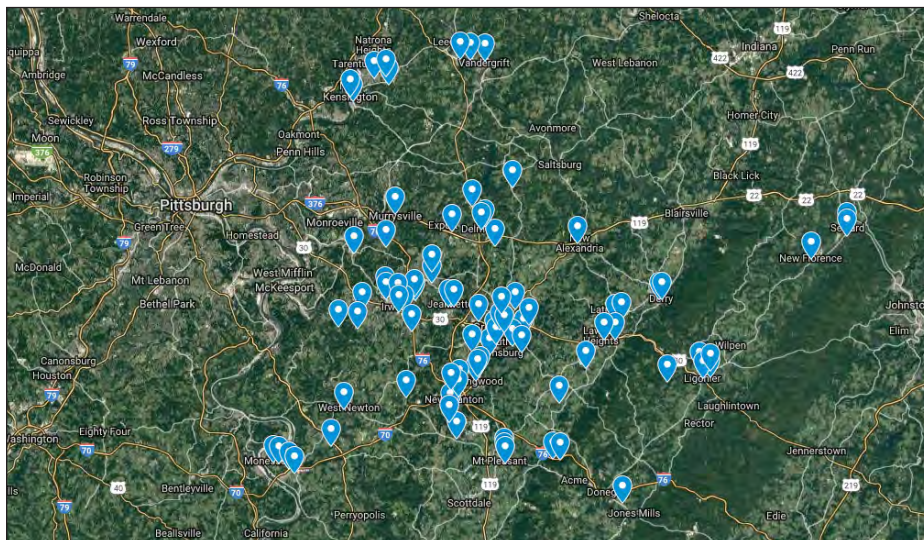

*Potential stormwater projects*

Conceptual projects like stream restoration and infiltration practices should be chosen specifically for the location and purpose to reduce stormwater volumes, improve water quality, and to solve existing stormwater issues identified across the county within each watershed.

The following projects are the most conventional and can be designed and implemented to abate the most common stormwater issues:

- Land acquisition in flood hazard areas
- Stream restoration, streambank restoration, flood plain restoration
- AMD / AML abatement and restoration
- Mechanical pollutant capture
- Flood control structures and
- Green infrastructure and stormwater management retrofits including:
  - o tree planting
  - o water quality detention basin
  - o permeable paving
  - o infiltration practices
  - o green roof and
  - o more

Westmoreland Conservation District (WCD) has many years of experience with this wide range of projects. Project sheets from the BMP Portfolio describing the design, construction, costs, and maintenance responsibilities of stormwater management retrofit projects that have been completed are located in the Appendices, and summarized here.

### LAND ACQUISITION

When a property or a neighborhood experiences repeated flooding, stability of a home or neighborhood is at risk. Recurring flooding can escalate costs for the property owner, the community and the state, and property values can be impacted; even injury or loss of life can occur. Additionally, emergency responders may risk their own lives to lend assistance to those impacted by rising waters. For these reasons, federal and state governments, sometimes with grant funding support from FEMA, have acted to intervene in some flood hazard areas by offering voluntary buyout programs to homeowners that have been subject to repeated flooding. Once purchased, a home or homes would be



demolished and the property designated as open space, or returned to a natural state as a flood plain or riparian buffer. Property acquisition is the most permanent form of flood hazard mitigation. Learn more at [www.fema.gov](http://www.fema.gov).

## STREAM RESTORATION

With population growth and the growth of cities, many small streams – which provide numerous clean water and recreational benefits – were buried. During much of our industrialization period, we did not realize the many benefits that small streams afforded us, so we often enclosed them in pipe systems. Small streams can provide a wide array of benefits to communities, such as nutrient and pollution removal, groundwater recharge, and flood mitigation. **Stream daylighting** is a relatively new approach that exposes some or all of a previously buried river, stream, or stormwater drainage and exists in several forms including:

- Natural restoration – restoring a stream to natural conditions;
- Architectural restoration – restoring a stream to open air, with flowing water located within a constructed channel;
- Cultural restoration – celebration of a buried stream through markers or public art used to inform the public of the historic stream path, although the stream remains buried.

- from *American Rivers*

**Streambank restoration** involves using hard armoring and bio-engineered plantings to prevent erosion of a stream. Certain water-loving plants with extensive root growth, such as willows, are used in this type of project. Stabilizing an eroded streambank can restore habitat and save the loss of thousands of tons of soil each year from a relatively short segment of stream. Economic benefits accrue also as damage to infrastructure is prevented.

**Floodplain restoration** requires more land, but it is effective for both environmental and safety reasons. Many streams in southwestern Pennsylvania have become incised, that is, they have eroded downward into their bed, forming a rectangular slot through which they flow. During floods, the excess water they carry has no place to spread out and be stored naturally. Floodplain restoration opens up an incised channel and allows the water to slow down as it spills out into the floodplain, thus reducing peak flows downstream.

A **riparian buffer** is a permanent area of perennials, trees, and shrubs

located adjacent to streams, lakes, ponds, and wetlands. Riparian forests are the most beneficial type of buffer for they provide ecological and water quality benefits. Restoration of this ecologically sensitive habitat is a responsive action to past activities that may have eliminated any vegetation. - from PA DEP Stormwater Management BMP Manual, 2006



*Impaired stream corridor before restoration, Westmoreland County Community College (WCCC), near Youngwood.*



*WCCC stream corridor after riparian buffer restoration*

Photo by Kathy Hamilton

Photo by Rob Cronauer



## AMD / AML ABATEMENT AND RESTORATION

Many of our county's streams have an orange hue. The water smells of sulfur or iron, the rocks in the bed are coated with orange mud, and aquatic life is absent. Although many long-time county residents accept this as normal, it really is a form of pollution by water coming from long-abandoned underground coal mines.

Abandoned Mine Drainage (AMD) can be either net acidic or net alkaline water laden with heavy metals such as iron, aluminum, manganese and others as well as sulfates. AMD originates through the oxidation of sulfide minerals (primarily Pyrite, FeS<sub>2</sub>). These sulfide minerals, while stable in their undisturbed environment, can be encountered during coal mining or other earth disturbance activities. Once exposed to oxidizing conditions, the sulfide minerals readily oxidize and quickly dissolve in surface and groundwater resulting in AMD pollution.



Photo by Brandon Battistella, Adam Eidemiller, Inc.

*This abandoned mine drainage passive treatment system in Lowber, PA, helps remove iron oxide pollutants from the mine water discharging from an old deep mine. The iron oxide gradually settles out as the mine water travels through a system of ponds and wetlands. The cleaned water then enters the Sewickley Creek.*

Treatment of AMD is frequently accomplished by allowing the mine discharge to settle out in large ponds, where natural processes allow the iron and other materials to come out of the water. Some of our watershed associations, including Mountain, Loyalhanna, and Sewickley, have AMD treatment sites cleaning up our streams.

## MECHANICAL CAPTURE OF POLLUTANTS

**Hydrodynamic structures** are devices designed to improve water quality by using features such as swirl concentrators, grit chambers, oil barriers, baffles, micropools, and absorbent pads designed to remove sediments, nutrients, metals, organic chemicals, or oil and grease from urban runoff. Often placed in storm inlets and manholes integral with a stormwater conveyance system, these devices are used in high density areas where there is limited space for stormwater water quality systems that require vegetation to break down pollutants.

The goal of **street sweeping** is to clean streets on a regular basis by either machine sweeping, hand cleaning, or flushing to eliminate debris and pollutants before they enter a storm sewer system or water of the commonwealth.

A **debris basin or netting system** captures and removes trash and floatables from stormwater and Combined Sewer Overflow (CSO) discharges. Flow energy drives floating debris and trash into a basin or a disposable mesh netting systems where pollutants are contained. Three-dimensional netting technology removes litter, trash and debris while providing a larger surface area than traditional two-dimensional screens and can accommodate a larger volume of material with lower maintenance frequency. Debris basins require a feasibility study, an engineered plan, and a funding source, but there are many commercially available systems available meeting a variety of parameters and budgets.

## FLOOD CONTROL STRUCTURES

Flood control projects are long term structural solutions to a community's flood problem. Considered in response to requests from municipalities, state and federal legislators, county and state government officials and private residents, recurring flood problems are investigated to determine the feasibility of providing solutions to these flood problems. Potential projects must be evaluated by assessing the magnitude and frequency of flooding, performing a hydrologic and hydraulic analysis, evaluating flood control alternatives, estimating construction costs,





*Flood control: Conemaugh Dam. Photo from US Army Corps of Engineers*

assessing environmental impacts, performing an economic analysis to determine a benefit/cost ratio, determining local sponsor responsibilities, and if appropriate, preparing project design for construction. Types of flood protection projects can include: concrete channels, concrete floodwalls, compacted earthen levees, channel improvements or a combination of a number of these types of alternatives. The main objective of flood control is to minimize property damage and the possibility of loss of life. A program to manage the inspection and rehabilitation of completed flood control projects also must be devised to protect and maintain the structure once complete. Flood control projects are expensive and take years to complete with the evaluation, assessment, analysis, design, funding and construction.

Due to the cost of flood control projects, the question may be raised: Can stormwater management practices be constructed instead? Can a green roof or a rain garden take the place of a flood control dam? The simple answer is that it would take an extremely high number of stormwater management practices to manage a water volume equal to

what a flood control project manages. Stormwater management is for the neighborhood; flood control is for the region.

## **GREEN INFRASTRUCTURE / STORMWATER MANAGEMENT RETROFIT PROJECTS**

### **Tree Planting**

Trees historically do more for stormwater management than almost any other type of management techniques, whether by preserving an existing tree or planting a new one. The amount of branching in a canopy of a tree is dwarfed by the amount of root system it has underground. Trees cool the water runoff before it reaches a waterway, keep the soil moist to promote faster infiltration rates, provide a large amount of water uptake, and break down pollutants.



*Planting canopy trees.*

Photo by Kathy Hamilton





Photo by Matt Zambelli

*Frick Hospital water quality basin in Mt. Pleasant, PA.*

### Water Quality Detention Basin

A **water quality stormwater basin** is a detention pond that intercepts stormwater runoff, provides volume reduction and removes pollutants. Stormwater quality improvement can be made by BMPs including a forebay, a micropool, a wet pool, or even a wetland. The longer the runoff remains in a stormwater basin, the more effective the basin will be in treatment of pollutants, the removal of sediments, nutrients, metals, organic chemicals, or oil and grease from runoff, especially if a vegetated edge is maintained.

A stormwater basin can come in many forms: as constructed wetlands which are shallow marsh systems planted with emergent vegetation designed to treat stormwater runoff; as wet ponds/ retention basins which include a permanent pool for water quality treatment; or as dry extended detention basins that provide temporary storage of runoff and function hydraulically to attenuate stormwater runoff peaks.

The dry detention basin, as constructed in countless locations since the mid-1970's and representing the primary BMP measure even until today, has served only to control the peak rate of runoff, although some

water quality benefit is accrued by settlement of the larger particulate fraction of suspended solids and trash. An extended detention basin enhances pollutant removal by modifying the basin outlet structure. Some volume reduction is also achieved in a dry basin through infiltration and some evaporation takes place during detention, but these are negligible. Existing detention basins constructed as volume control only can become water quality basins by retrofitting riser structures and basin layout to provide sediment and nutrient removal, infiltration or extended detention time.

### Permeable Paving

The ability to infiltrate the rain where it falls is the key to utilizing permeable paving systems. Given that many thousands of acres of parking exist in our county, providing a 'green' or environmentally friendly way to park cars without generating extra runoff is quite important. Permeable paving should be constructed on nearly level to gently sloping sites with a deep stone base to provide volume for storage and slow infiltration rates. The surface course may consist of porous asphalt, porous concrete, concrete blocks, bricks, or plastic grids. More expensive than other stormwater management techniques, permeable paving allows the paving to manage its own volume of stormwater runoff and can provide a signature look to the finished site.



Photo by Kathy Hamilton

*Permeable paving demonstration at J.Roy Houston Conservation Center, Greensburg, PA.*



## Infiltration practices

An infiltration system encourages stormwater to soak into underlying layers of soil to replenish the groundwater, to provide water uptake by vegetation and to break down pollutants in the process. Infiltration systems come in many shapes, sizes and styles. An infiltration basin is a shallow impoundment that stores and infiltrates runoff over a level, uncompacted (preferably undisturbed) area with relatively permeable soils. An infiltration trench is a “leaky” pipe in a stone filled trench with a level bottom, and may be used as part of a storm sewer system, especially to replace a relatively flat section of storm sewer.

A **rain garden** (also called **bioretention**) is an excavated shallow surface depression planted with specially selected native vegetation to treat, capture, and provide uptake of runoff. As its name implies, a rain garden can be a rather attractive area, landscaped to fit in to the surroundings, and while functional, can also add beauty to a property. Stormwater from a roof or paved area fills the rain garden and soaks slowly into the ground; some is taken up by the plants during the growing season also.



*A wet rain garden at the GreenForge building, Greensburg, PA*



*A greenroof covers 9,000 square feet at the GreenForge building, Greensburg, PA.*

## Green Roof

A **green roof** is a layer of vegetation that is grown on and completely covers an otherwise conventional flat or pitched roof (less than 3 percent slope), endowing the roof with hydrologic characteristics that more closely match surface vegetation than the roof. The overall thickness of an extensive green roof may range from 2 to 6 inches and may contain multiple layers, consisting of waterproofing, synthetic insulation, drainage layer, engineered growth media, separation fabrics, and non-invasive vegetation. Vegetated roof covers can be optimized to achieve water quantity and water quality benefits. Through the appropriate selection of materials, even thin vegetated covers can provide significant rainfall retention and detention functions.

Photo by Kathy Hamilton

Photo by Kathy Hamilton



## EFFECTIVENESS VALUES

The PA DEP has created a list of BMPs and their effectiveness titled 'NPDES Stormwater Discharges from Small Municipal Separate Storm Sewers BMP Effectiveness Values,' which is available on their website. Primarily intended for use by MS4s that are developing and implementing Pollutant Reduction and TMDL Plans to meet permit requirements, the values consider pollutant reductions from both overland flow and reduced downstream erosion. Following design considerations, operation and maintenance, and construction sequences outlined in the PA DEP Stormwater BMP Manual, or other technical guidance, this table can be used as a guide to reduce impairments.

[http://www.depgreenport.state.pa.us/elibrary/GetDocument?docId=11069&DocName=3800-PM-BCW0100m%20BMP%20Effectiveness%20\(Final\).pdf](http://www.depgreenport.state.pa.us/elibrary/GetDocument?docId=11069&DocName=3800-PM-BCW0100m%20BMP%20Effectiveness%20(Final).pdf)

## COSTS

Costs vary from project to project, related to location, size, materials, technique, and other factors. Techniques should be chosen to meet the existing site conditions and to solve the identified stormwater issue. The adjacent chart is a representation of gallons of runoff treated and cost of BMP construction per gallon of runoff treated.

Learn more by reviewing the BMP Portfolio pages in the Appendices.

## FUNDING

Funding sources can be found at federal, state, and local levels, or local communities or organizations can create authorities or funding streams of their own to provide the funds to pursue project development. Many opportunities are listed in the IWRP Chapter 6: Action Plan under "Initiatives."

## Stormwater Volume Control

during 1 inch rainfall



## Stormwater Treatment Costs

per gallon



## Chapter 6. ACTION PLAN

With much information gathered about water, what's next? What can anyone do about water problems, and what can anyone do to help conserve or sustain our water resources? Latrobe native Mr. Rogers might counsel us to "Look for the helpers." Indeed there are many helpers working on water resource issues, from large federal agencies to local grass-roots watershed groups, and there are many possible strategies to implement in order to solve these issues. The Westmoreland County IWRP, Chapter 6, outlines both helpers and strategies for helping our water resources.

Taking action on stormwater requires both expertise and funding. Various initiatives provide these in varying forms to municipalities, watersheds, and land owners hoping to address problems. Financial help is available in the form of grants, low-interest loans, or dedicated sources of funding. Technical help is most often given for free by the many agencies, including the Westmoreland Conservation District (District). Some sources of funding do require a 'match' of either dollars or time or both.

Implementing water resource management plans or projects will always begin with a plan. Once again the various federal, state, local, or private/grass-roots groups will be of assistance. Wise planners will identify the problems, prioritize them, and form a plan to address solutions. Sometimes the smallest problems can be solved the easiest—although solving water-related problems is often quite complicated as one must deal with land owners, utilities, buildings, roads, the railroad and other entities.

A few of the programs available for technical assistance and funding are listed here.

### INITIATIVES

Lack of knowledge and lack of funding are consistently cited as barriers to the implementation of stormwater management retrofits and the use of green infrastructure to correct stormwater issues and reduce pollutants. To address the lack of knowledge, many federal, state and local agencies and universities are at the cutting edge of research and education initiatives for innovative ways to manage and sustain our water resources. Each of these provide accessible information and as-



Photo by Kathy Hamilton

*Rain garden and permeable paving in Scottdale Library's reading garden funded by EPA 319, 2011*

sistance across numerous websites for anyone searching out this information. To compete for a variety of diverse funding sources available at the federal, state, and local levels, innovative and green infrastructure projects have an advantage over conventional work with the ability to generate many stormwater benefits. Links to various research websites are found in our Integrated Water Resources Plan Library in the Appendices and on-line at [www.westmorelandstormwater.org](http://www.westmorelandstormwater.org).

### FEDERAL

The mission of the **Environmental Protection Agency (EPA)** is to protect human health and the environment. Born in the wake of elevated concern about environmental pollution, the EPA was established in 1970 to consolidate a variety of federal research, monitoring, standard-setting and enforcement activities into one agency. Since its inception, the EPA has been working for a cleaner, healthier environment for the American people. It provides information and assistance with air quality; chemicals and toxins, health, green living, land, waste and cleanup, environmental information where you live, science, and water quality.



EPA research supports efforts under the Clean Water Act and Safe Drinking Water Act, providing research, information and assistance related to all water issues, including drinking water quality, watersheds and rivers, waste water and stormwater runoff, and infrastructure financing and assistance.

Learn more at [www.epa.gov](http://www.epa.gov).

**EPA Clean Water Act Nonpoint Source Grant** (Section 319 Grants) – Congress amended the Clean Water Act in 1987 to establish the EPA's Section 319 Nonpoint Source Management Program to provide greater federal leadership in focusing state and local nonpoint source efforts. Under Section 319, states can receive grant money to support a wide variety of activities, including:

- technical and financial assistance;
- education and training;
- technology transfer;
- demonstration projects; and
- monitoring to assess the success of projects implemented under the grant.

For more information go to <https://www.epa.gov/nps/319-grant-program-states-and-territories>.

**EPA Clean Water State Revolving Fund** (CWSRF) – The CWSRF program is a federal-state partnership that provides communities a permanent, independent source of low-cost financing for a wide range of water quality infrastructure projects, including stormwater and green infrastructure. Learn more about the program in the Green Infrastructure Approaches to Managing Wet Weather with Clean Water State Revolving Funds fact sheet.

**EPA Drinking Water State Revolving Fund** (DWSRF) – A drinking water counterpart to the CWSRF, the DWSRF program is a federal-state partnership that provides communities with a permanent, independent source of low-cost financing for drinking water systems and state safe water programs. Green infrastructure projects that improve source water quality and/or quantity or maximize reliance on natural hydrological functions may be eligible for funding.

Additional opportunities may be found at <https://www.epa.gov/green-infrastructure/green-infrastructure-funding-opportunities> and <https://www.epa.gov/sdwa>



Photo by Rob Cronauer

*WCD Americorps worker Alyssa Harden stands by a riparian buffer designed to protect Cherry Creek at Westmoreland County Community College's Youngwood campus.*

**Americorps** is a network of national service programs, made up of three primary programs that each take a different approach to improving lives and fostering civic engagement. Members commit their time to address critical community needs like increasing academic achievement, mentoring youth, fighting poverty, sustaining national parks, preparing for disasters and more.

For more information refer to <https://www.nationalservice.gov/programs/amicorps>.

**USDA – NRCS** – US Department of Agriculture Natural Resource Conservation Service programs provide financial and technical assistance to help eligible agricultural producers: construct or improve water management or irrigation structures (Agricultural Management Assistance - AMA); improve resource conditions such as soil quality, water quality, air quality, habitat quality, and energy (Conservation Stewardship Program - CSP); and implement conservation practices, or activities, such as conservation planning, that address natural resource concerns on their land (Environmental Quality Incentives Program - EQIP). In specific states and locations, funding may also be available for priority issues such as air quality, agricultural energy management plans, seasonal high tunnels and organic operations. Visit your state's EQIP page for more information. <https://www.nrcs.usda.gov>



Photo by Dan Griffith

*Vegetated contour strip diversions on farm funded by NRCS's EQIP program.*

**US Fish and Wildlife** – The mission of the U.S. Fish and Wildlife Service (USFWS) is working with others to conserve, protect and enhance fish, wildlife, plants and their habitats for the continuing benefit of the American people. They are both a leader and trusted partner in fish and wildlife conservation, known for scientific excellence, stewardship of lands and natural resources, dedicated professionals and commitment to public service.

The USFWS issues financial assistance through grants and cooperative agreement awards to commercial organizations, foreign entities, Indian tribal governments, individuals, institutions of higher education, non-profit organizations, and state and local governments.

Learn more at [www.fws.gov](http://www.fws.gov).

The **Center for Watershed Protection (Center)** is a private group that works to protect and restore our streams, rivers, lakes, wetlands and bays from the impacts of land use activities. They have an experienced staff of scientists, planners and environmental professionals who help municipalities, advocates, policymakers and citizens get clean water projects in the ground.

Founded in 1992, the Center was established with the idea of creating a nonprofit organization dedicated to research and education on watersheds. With an initial focus on protecting urban streams from

the impacts of land development, the organization has grown over the years to become a national leader on stormwater management and watershed planning. The Center has continued to maintain the basic premise that watersheds are a logical focus point for environmental efforts, and their services have expanded to include membership and direct assistance to communities.

Learn more at [www.cwp.org](http://www.cwp.org).

## INTERSTATE

Since 1948, **Ohio River Valley Water Sanitation Commission (ORSANCO)** and its member states have cooperated to protect the various ways water is used in the basin and to improve water quality for the citizens of the Ohio River Valley. The Ohio River is a source of drinking water for over five million people, a major transportation route for coal and other energy products, and a natural resource for many plants and animals. ORSANCO works along with many other state and local agencies and organizations to provide safe drinking water, protect aquatic life, guide fish consumption, and inform citizens with information about recreational activities in and around the river.



*Ohio River Basin - ORSANCO*



## State Partners

- Illinois Environmental Protection Agency
- Indiana Department of Environmental Management
- Kentucky Environmental and Public Protection Cabinet
- New York Department For Environmental Conservation
- Ohio Environmental Protection Agency
- Pennsylvania Department of Environmental Protection
- Virginia Department of Environmental Quality
- West Virginia Department of Environmental Protection

## Federal partners

- NOAA Satellite and Information Service
- U.S. Army Corps of Engineers
- U.S. Environmental Protection Agency
- U.S. Fish and Wildlife Service
- U.S. Geological Survey

## Other Partners

- Ohio River Basin Alliance (ORBA)

Learn more at [www.orsanco.org](http://www.orsanco.org).



Photo by ORSANCO

WCD Board member, Chuck Duritsa (5th from right) participates in an ORSANCO meeting of representatives from across the Ohio River Basin.

## STATE

**Pennsylvania's Dirt Gravel, and Low Volume Road Maintenance Program** (Program) - provides funding to eliminate stream pollution caused by runoff and sediment from the state's comprehensive network of unpaved and low volume public roads. The Program was enacted into law in April 1997 as Section 9106 of the PA Vehicle Code, with \$5 Million in annual funding for "environmentally sensitive road maintenance" for unpaved roads. The goal of the Program is to create a more environmentally and economically sustainable low volume road network through education, outreach, and project funding. Pennsylvania's Conservation Districts are responsible for administering the Program at the county level. Local road-owning entities, typically municipalities, then apply to their Conservation District for project funding.

Learn more at <https://www.dirtandgravel.psu.edu>



Photo by Rob Cronauer

Installation of a cross drain for a dirt and gravel road funded project in 2013.

## **Pennsylvania Infrastructure Investment Authority (PENNVEST)**

was founded on March 1, 1988, and services the communities and citizens of Pennsylvania by providing low cost financial assistance to fund sewer, storm water and drinking water projects. These projects not only contribute to improving Pennsylvania's environment and the health of its people, they also provide opportunities for economic growth and jobs for Pennsylvania's workers. PENNVEST provides a variety of programs:

- Low interest loans (with some grant funding available) for Drinking Water, Wastewater, Storm water and Non-Point Source Pollution Prevention Projects to pay for costs associated with design, engineering, and construction of public or private owned drinking water or wastewater systems, non-point source pollution mitigation and storm water projects. These include green initiatives for water quality management that promote and encourage environmental responsibility in our communities.
- Low interest loans to individuals to finance repair or replacement of their malfunctioning on-lot system for their primary residence, first time connection to public system, and in some cases replacement of existing connections to reduce inflow and infiltration.
- Low interest Brownfield Redevelopment loans available for remediation of sites related to water quality benefits.
- Supplemental grants on a limited basis for systems with residential user rates, or with limited capacity to handle debt service. No separate application is necessary. Analysis is performed on each submittal for grant consideration.

Learn more at <http://www.pennvest.pa.gov>.

**PA DEP GROWING GREENER** - Funds are distributed among four state agencies: the Department of Agriculture to administer farmland preservation projects; the Department of Conservation and Natural Resources (DCNR) for state park renovations and improvements; and **PENNVEST** for water and sewer system upgrades. **PA DEP** is authorized to allocate these funds in grants for watershed restoration and protection, abandoned mine reclamation, and abandoned oil and gas well plugging projects.

Learn more at <http://www.dep.pa.gov/Citizens/GrantsLoansRebates/Growing-Greener/Pages/default.aspx>



Photo by Kathy Hamilton

*Street trees planted in a soil containment system beneath a permeable concrete sidewalk in Vandergrift, funded by PA DEP Growing Greener, 2010 .*

**PA DCNR** – Department of Conservation and Natural Resources Bureau of Recreation and Conservation (BRC) assists local governments and recreation and conservation organizations with funding for projects related to parks, recreation, and conservation.

Learn more at <http://www.dcnr.pa.gov>.

**PA Department of Community and Economic Development (PA DCED)** – provides numerous programs and funding opportunities for business, communities and local governments through grants, loans, loan guarantees, tax incentives and bonds for AMD, abandoned mine land (AML), water quality, infrastructure, flood mitigation and control, water supplies, sanitary sewer and stormwater projects.

Learn more at <https://dced.pa.gov>.

**PA ACT 13** - PA Act 13 of 2012 is a comprehensive law that affects Oil and gas operations in the state to:

- Collect an impact fee on all unconventional wells drilled in the state
- Create the Natural Gas Development Program to increase the use of natural gas for transportation
- Strengthen existing environmental regulations and create new standards for unconventional well drilling
- Improve consistency among local zoning regulations in the state



From the impact fees collected, Act 13 earmarks a portion for state agencies to offset the statewide impact of drilling: 40% to the Marcellus Legacy Fund for environmental initiatives, and the remainder of the fees collected is distributed to the Unconventional Gas Well Fund for counties and municipalities (60%). The Act is administered by the PA Public Utility Commission (PUC); funding is distributed in part by PA DCED.

The Marcellus Legacy Fund was created by Act 13 of 2012 to provide for the distribution of unconventional gas well impact fees to counties, municipalities, and Commonwealth agencies. A portion of the fee revenue will be transferred to the Commonwealth Financing Authority for statewide initiatives that will include abandoned mine drainage abatement, abandoned well plugging, sewage treatment, greenways, trails and recreation, baseline water quality data, watershed restoration, and flood control.

Learn more from the PUC at <http://www.puc.state.pa.us>

Learn more from the PA DCED at <https://dced.pa.gov/programs-funding/commonwealth-financing-authority-cfa/act-13-programs/>.

**PENNDOT** – Highway stormwater systems can be installed by PennDOT, a public applicant through a Highway Occupancy Permit (HOP), a local government, or a combination thereof. Maintenance responsibility of both existing and new systems depends on multiple factors. Information regarding the planning, design, construction, and maintenance of stormwater management systems in state highway right-of-way can be found at <http://www.penndot.gov/Doing-Business/LocalGovernment/StormWaterManagement/Pages/default.aspx>.

**BOND FORFEITURE** – Coal mining operations are required to post a bond with PA DEP to ensure proper reclamation of surface areas affected by the mining work. Bonds on projects like strip mining operations can be forfeited when an operator abandons a site. These moneys can be used to perform reclamation and improvements on sites to manage runoff and establish vegetated cover. When bond money is insufficient it can be supplemented with other funds. <http://www.dep.pa.gov/Business/Land/Mining/BureauofMiningPrograms/Bonding/Pages/default.aspx>

**FINES** – In some cases, active projects that cannot maintain proper or consistent erosion and sedimentation and/or stormwater management controls, according to their approved permit, may be fined by PA DEP. This fine money may be distributed, at the discretion of PA DEP, to benefit those areas most affected by the project in violation of their



Photo by Rob Cronauer

*AMD treatment facility at Brinkerton, sponsored by Sewickley Creek Watershed Association, funded by PA BAMR, 2012.*

permit. Usually the fine money goes to an environmental project in the same watershed as the violation.

**PA BAMR** - The Bureau of Abandoned Mine Reclamation (BAMR) administers and oversees the Abandoned Mine Reclamation Program for coal and abandoned mine land (AML) reclamation and the abandoned mine drainage (AMD) abatement and treatment program in Pennsylvania. The bureau is responsible for resolving problems such as mine fires, mine subsidence, dangerous highwalls, open shafts and portals, mining-impacted water supplies and other hazards, and to address AMD which have resulted from past coal mining (pre-1977) practices in accordance with requirements established by the federal Office of Surface Mining under authority of the Surface Mining Control and Reclamation Act.

Learn more at <http://www.dep.pa.gov/Business/Land/Mining/AbandonedMineReclamation/Pages/AMD-Set-Aside-Program.aspx>.

## REGIONAL

The **Southwestern Pennsylvania Commission (SPC)** is the cooperative forum for regional collaboration, planning, and public decision-making for the 10 county region. Operating with public involvement and trust, the Commission develops plans and programs for public investments, and fulfills federal and state requirements for transportation, economic development, and local government assistance programs. SPC is responsible for planning and prioritizing the use of all state and federal transportation funds allocated to the region.

Learn more at [www.spcregion.org](http://www.spcregion.org).

**Private Foundations** – Several private foundations are based in southwestern PA and will fund worthwhile campaigns or projects that are innovative and benefit the region. Many will give support to environmental causes; one just has to study the individual foundation website to find out.

**Private companies** – Many local companies are willing to invest in the sustainability of the community. Some have active campaigns reaching out to local environmental organizations, while others only need to be approached with an idea to partner on worthwhile projects. Consistent support for WCD has been forthcoming from Peoples Natural Gas and West Penn Power and Dominion have both provided volunteers and funds for work days and cleanups.

**StormwaterPA** is a private group that was established in 2007 to fill a growing information gap and to provide the impetus for key stakeholders to put better stormwater programs and practices in place. The program has since evolved into an important source of news, information, discussion, and from-the-field examples of collaborative efforts that are protecting water resources, improving community health, and growing local economies.

StormwaterPA is an initiative of GreenTreks Network, Inc., a Philadelphia-based non-profit communications organization whose mission is moving people towards a more sustainable world.

Learn more at [www.stormwaterpa.org](http://www.stormwaterpa.org).

## LOCAL

Headed by Westmoreland County's commissioners and county agencies, Westmoreland County also has initiatives to reach sustainability of our water resources. **The County Comprehensive Plan - Reimagining Our Westmoreland** is one initiative. Westmoreland County faces the

challenges of an aging and decreasing population base, and a lack of available jobs and housing choices for newcomers. This means a reducing pool of residents and employees are available to sustain a healthy economy. Westmoreland County's Comprehensive Plan, *Reimagining Our Westmoreland*, has pointed out that we need to realign the county's priorities to attract people to call Westmoreland home and has developed 7 core objectives to meet these challenges and new priorities. The core objectives are to:

- align the workforce to create a stronger community
- promote the county as a place to live, work, and play
- recreate our aging urban centers into communities with housing, business opportunities and amenities to attract residents from all walks of life
- protect and promote our open spaces and natural features
- create more sustainable and healthy communities
- utilize new technologies
- create more choices in transportation

Utilizing planning best practices and initiatives to tackle specific planning issues in the county, we can protect our natural assets and water resources. *Reimagining Our Westmoreland* recommends minimizing development in areas without public water/sewer and promoting the county's open spaces and natural areas including our rich agricultural tradition. By preserving open space and focusing future development within the bounds of existing infrastructure service areas, municipalities can promote denser growth in downtowns, reduce barriers to small scale re-development in urban cores, eliminate blight, and prevent overextension of our water resources.





The County Plan will guide municipalities toward higher standards for quality land development, and help them address the fragmentation of local government to make the navigation of amenities, opportunities and services more accessible. By investing in upgrading existing infrastructure, promoting healthy lifestyles, and educating the community, the quality of life for residents and visitors in the county will increase. By promoting sustainable practices, partnerships and shared services among communities in the same watershed, our municipalities can address stormwater issues together to create more sustainable communities. Learn more at [www.co.westmoreland.pa.us](http://www.co.westmoreland.pa.us)

The **Westmoreland Conservation District (District)** is a leader and advocate for innovative stormwater management and has spearheaded this IWRP to meet PA Act 167 requirements and to reach toward sustainable water resources in Westmoreland County. Designing and overseeing the installation of stormwater management best practices across the county, the District also uses our experience to help educate the general public and professional audiences about our water resources. To reach these audiences, District staff participate in nearly 50 different educational events per year, either by hosting and organizing events or collaborating with other organizations and agencies on their educational programs. The District also produces printed educational materials and maintains a digital presence with our website, Facebook page, electronic newsletter, and YouTube channel.



Photo by Kathy Hamilton

*Permeable paving parking demonstration at the J.Roy Houston Conservation Center funded by Richard King Mellon Foundation, 2016.*

In all, the District reaches thousands of people each year with our message of conservation.

The following are specific examples of current District programs:

- The Stormwater Trail at our J. Roy Houston Conservation Center office features a variety of stormwater best management practices. These sites are open to the public and feature interpretive signage describing each of the techniques. Some of these practices are fitted with monitoring devices to help evaluate their effectiveness. WCD staff also provide tours of the stormwater trail and can review monitoring data with interested parties.
- Best Management Practices (BMPs) around the county are featured on the District's online BMP Portfolio. Parties interested in learning more about the installation, maintenance, and success of these BMPs can view factsheets and photos of these sites. <http://wcdpa.com/bmp/>
- The Homeowner's Guide to Stormwater and the BMP Toolkit are publications designed to help homeowners evaluate stormwater flow on their property and design innovative ways to manage it. <http://wcdpa.com/tech-services/stormwater-management/best-management-practice-bmp-toolkit/>
- MS4 Workshops are designed for homeowners, homeowner associations, and public works departments. District staff work with municipalities to provide these workshops as a way to fulfill the municipal permit requirements.
- The annual Engineer's Workshop highlights the latest techniques and policy updates in natural resource management. It attracts nearly 400 natural resource professionals from southwestern Pennsylvania.

Moving forward, the District recently adopted a strategic plan for 2019 to 2021. Prepared by the Bayer Center for Nonprofit Management, the plan sets forth the goal to "Focus on maintaining high quality core programs [and] actively develop monitoring and science based programs." This includes implementing the county IWRP.

Specifically, the District looks to do the following endeavors:

- Engage county agencies, authorities, environmental groups, and municipalities in cooperative programs to meet IWRP goals for sustainable water resources



Photo by Kathy Hamilton

WCD engineer Jim Pillsbury addresses nearly 200 environmental professionals attending the 2018 Engineer's Workshop at the Fred Rogers Center, Saint Vincent College in Latrobe, PA.

- Participate in the formation of sustainable methods or authorities to provide funding streams for installation, monitoring, operation, and maintenance of stormwater BMPs
- Promote watershed wide programs for the monitoring, operation, and maintenance of stormwater management BMPs
- Facilitate stakeholder discussions concerning the formation of a stormwater bank to address long-term stormwater issues including property acquisition in flood hazard areas, establishment of riparian buffers, stormwater management retrofits, etc.

Learn more at [www.wcdpa.com](http://www.wcdpa.com)

**Watershed associations** are generally non-profit, volunteer organizations, although four out of seven in our county have full or part-time staff. They are all dedicated to the conservation of our natural resources, rehabilitation of our waterways and watersheds, environmental education and recreation. Often run by a board of directors, they rely on local and regional funding sources and volunteers for man-power and local expertise to address water and pollution issues in their watershed.

They perform tasks like:

- Organizing and participating in highway clean-up events, river sweeps, and tackling illegal dump sites
- Providing environmental educational programs to K-12 students and adults
- Purchasing and maintaining properties for recreational opportunities, writing and installing canoe and kayak launches
- Writing grants to stabilize streambanks and improve fish habitat, improving AMD discharges, maintaining and monitoring existing treatment systems
- Raising funds to stock trout
- Organizing fundraisers like golf outings, duck races, sale of small game of chance tickets, 5K races, etc. to cover daily operational costs
- Monitoring and collecting water samples of streams and AMD treatment systems

Watershed associations, like most volunteer driven organizations, are always looking for new volunteers and leadership with new ideas and skills like funding, finances, education, writing, social media, engineering



Photos by Alyssa Harden

Turtle Creek Watershed Association's 2018 Rubber Duck Race fundraiser—Murrysville.



and construction. Looking to the future, these altruistic organizations are looking to partnerships, alternative funding sources, technology for outreach and education, and volunteers to guarantee succession and viability of their organizations into the future. Bolstered by the partnership and support from the District, several of the watershed groups have recently become more successful and have been able to achieve more water quality awareness and benefits.

The sustainability of watershed associations into the future will rely on their ability to:

- Host events to involve the community
- Engage volunteers with interactive displays at tabling events
- Reach younger audiences through social media and events that show “You can make a difference”
- Provide educational events for professional certification
- Partner with more like minded groups and municipalities within the watershed and region to maximize funding opportunities, administration of programs and meeting MS4 requirements

Learn more or find out how to volunteer by contacting your local watershed association. Watershed groups are listed in the Appendices.

The **Westmoreland County Agricultural Land Preservation (WCALP)** program was established in 1990 to conserve and protect agricultural lands by acquiring voluntary agricultural conservation easements to prevent the loss of productive agricultural land.

Preserving farmland not only provides local meat and produce, but keeps valuable open space, and reduces the impacts of stormwater to our streams and lakes. The program has been approved by the PA Department of Agriculture, and operates within the guidelines of the Agricultural Security Areas Law. Over 80,000 acres are currently enrolled in Agriculture Security Areas in 20 townships in the county and over 12,645 acres have been enrolled under an Agricultural Conservation Easement in perpetuity. The program also promotes Clean & Green Preferential Tax Assessment, Pennsylvania’s Century and Bicentennial Farm Program and the Preserved Farm Resource Center.

**Agricultural Security Areas (ASA)** are established on a voluntary action by the farmland owner(s) who petition their local governing body (municipality) to create an ASA. This tool for protecting our farms from encroachment of non-agricultural uses provides benefits to farmland



*Cows out to pasture in Ligonier Township.*

owners in three ways:

1. The local officials agree to support agriculture by not passing nuisance laws, which would restrict normal farming operations.
2. Limitations are placed on the ability of government to condemn farmland in the ASA for highways, parks, schools, etc.
3. Landowners will be eligible to voluntarily apply to sell an agricultural conservation easement to the Commonwealth and County.

**Agricultural Conservation Easements (ACE)** prevent the development or improvement of the land for any purpose other than agricultural production. A farmland owner in an ASA may voluntarily apply to be selected for the sale (or donation) of an agricultural conservation easement through the Westmoreland County Agricultural Land Preservation Program, acting through the PA Dept. of Agriculture. The program was developed in 1989 to strengthen Pennsylvania’s agricultural economy and protect prime farmland. Pennsylvania, as a matter of public policy, is preserving farmland at a speed greater than any other state. In addition to being a part of an Agricultural Security Area (ASA), the parcel of land is ranked against other eligible parcels according to several criteria that consider:

- Quality of Farmland
- Surrounding Land Use
- Likelihood of Conversion

The long-term goal of the program is to permanently preserve farmland for future generations.

Learn more at [www.wcalp.org](http://www.wcalp.org).

## Agriculture Security Areas

### Legend

- Westmoreland Municipalities
- Agriculture Security Areas

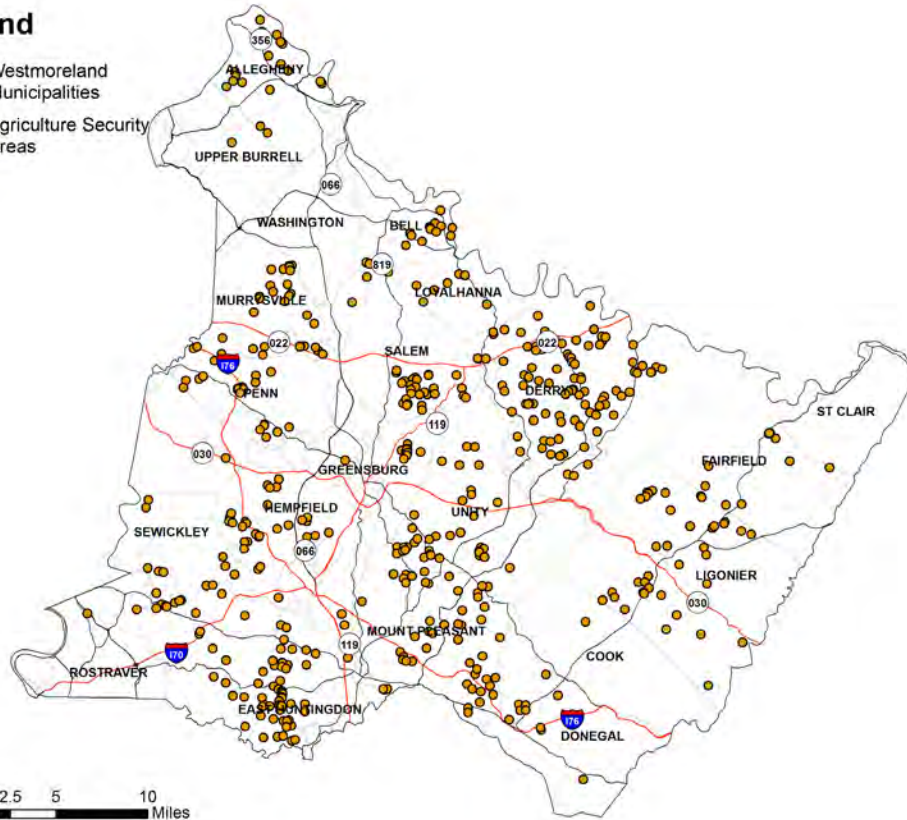

## IMPLEMENTATION STRATEGY

The **Westmoreland County IWRP Implementation Strategies** have been developed through the process of reviewing our **Water Resources** in Chapter 3, evaluating the **Impacts** of water use, development and climate change in Chapter 4, and performing an in depth study of the **Issues and Challenges** facing our water resources into the future

through the watershed and pollutant modeling of the county's priority watershed areas of interest in Chapter 5. The strategies listed below should help us achieve the IWRP goals of **Advancing Sustainable Water Resources, Encouraging Partnerships, Providing Accessible Information, and Meeting Regulatory Mandates**. The following chart lists the proposed implementation strategies, and some are described in greater detail in the remainder of this chapter.

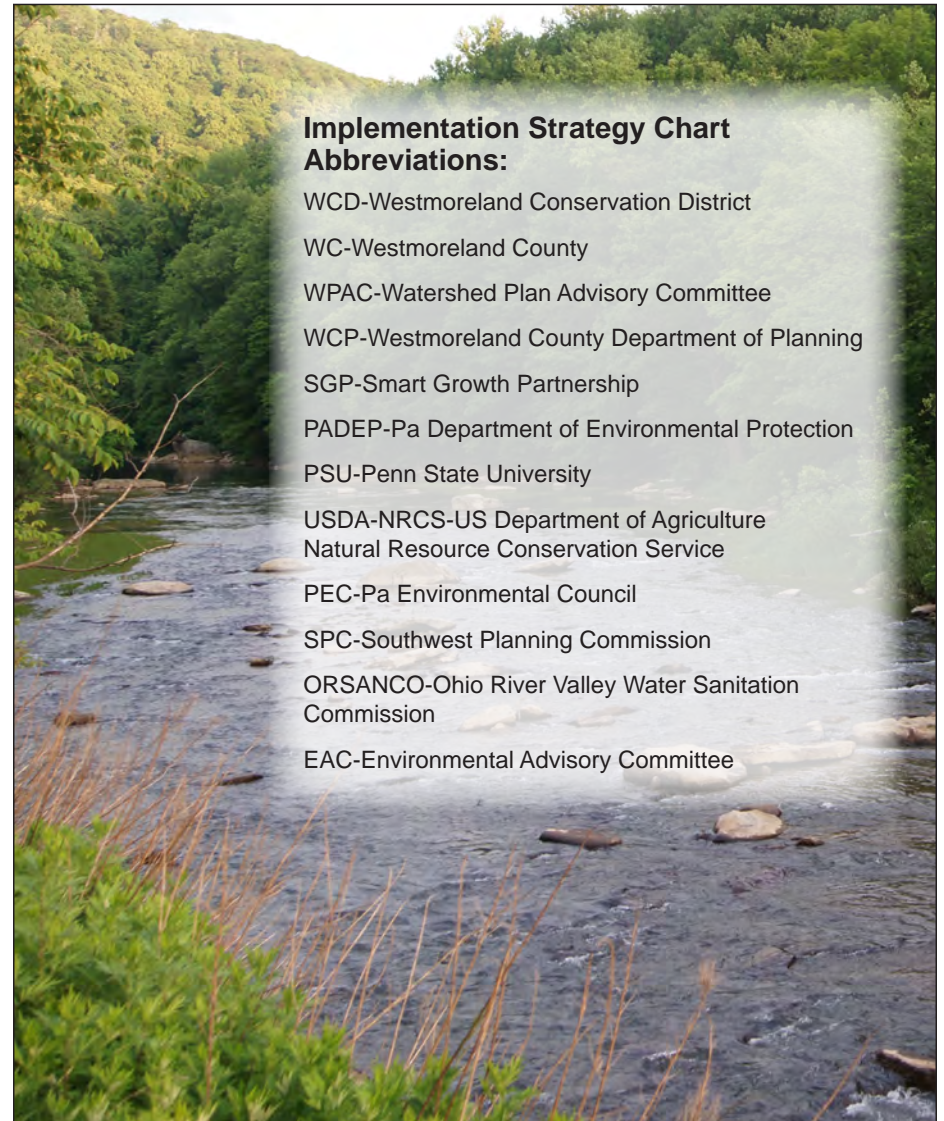

### Implementation Strategy Chart Abbreviations:

- WCD-Westmoreland Conservation District
- WC-Westmoreland County
- WPAC-Watershed Plan Advisory Committee
- WCP-Westmoreland County Department of Planning
- SGP-Smart Growth Partnership
- PADEP-Pa Department of Environmental Protection
- PSU-Penn State University
- USDA-NRCS-US Department of Agriculture Natural Resource Conservation Service
- PEC-Pa Environmental Council
- SPC-Southwest Planning Commission
- ORSANCO-Ohio River Valley Water Sanitation Commission
- EAC-Environmental Advisory Committee

*Loyalhanna Creek flowing through Loyalhanna Gorge.*

Photo by Stephen Simpson



<b>Implementation Strategy</b>	<b>Priority 0-ongoing 1-immediate 2-short term 3-long term</b>	<b>Preferred Management Entity</b>	<b>Partner(s)</b>
<b>Goal 1: ADVANCE SUSTAINABLE WATER RESOURCES</b>			
* Complete the watershed and pollutant modeling for the balance of the Westmoreland County watersheds listed in the IWRP and create recommended Performance District mapping	0	WCD	WCP
Promote Smart Growth policies in an effort to minimize the impact that development has on water resources	0	SGP	WCD, PADEP
Staff a Water Resources Coordinator in order to contribute to the resolution of the County's water resource related issues	3	WCD	WCP
* Encourage the establishment of a Stormwater Authority(ies) to assume responsibility for all stormwater facility management and oversight in the County	3	WC, MUNICIPALITIES	WCD
Pursue stormwater management project opportunities in susceptible areas to reduce flooding and improve water quality	0	ALL	ALL
<b>Goal 2: ENCOURAGING PARTNERSHIPS TO SUPPORT WATER RESOURCE INITIATIVES</b>			
Work in coordination with other County agencies and departments	0	WCD	WCP, WC911, WC PUBLIC WORKS
Maintain partnerships with local water related organizations	0	WCD	WATERSHEDS
Promote coordination and cooperation between local, State, and regional organizations/agencies	0	WCD	PADEP, FEMA, SPC
* Form new partnerships to support watershed initiatives and projects	1	WCD	ALL
Promote the establishment of municipal and joint municipal Environmental Advisory Councils (EACs)	2	WCD	MUNICIPALITIES, WATERSHEDS, PEC, WPC
Work with PennDOT and/or PA Turnpike Commission (PTC) on roadway projects to satisfy water quality requirements	0	WCD	PENNDOT, PTC
Implement the Hazard Mitigation Plan component of the County Comprehensive Plan to address water related issues	0	WC911	WCD, MUNICIPALITIES
Participate in the development and implementation of the Ohio River Basin Plan(s)	2	ORSANCO	WCD

<b>Implementation Strategy</b>	<b>Priority</b> 0-ongoing 1-immediate 2-short term 3-long term	<b>Preferred Management Entity</b>	<b>Partner(s)</b>
<b>Goal 3: PROVIDING ACCESSIBLE INFORMATION ON WATER RESOURCES</b>			
Serve as a water resources information and referral center	0	WCD	PADEP, PSU, USDA-NRCS, ETC
Maintain an information website on water-related and planning issues, and forum for exchange of ideas	0	WCD	WCP
* Maintain the IWRP decision making flowchart tool on the www.westmorelandstormwater.org website	0	WCD	CONSULTANT
Provide education to County stakeholders on water-related topics	0	WCD	WATERSHEDS
* Periodically review and update the IWRP as necessary	1	WCD	WPAC
* Continue sampling, monitoring, and reporting on Westmoreland County water resources	0	WCD	WATERSHEDS, CONSULTANT
Publish any new water related data that is acquired in the IWRP	1	WCD	PADEP
<b>Goal 4: MEETING REGULATORY MANDATES FOR WATER RESOURCES</b>			
* Assist municipalities with adoption of a stormwater management ordinance consistent with the Model Stormwater Ordinance in the County IWRP	1	MUNICIPALITY	WCD, WCP
Provide assistance to MS4 communities to meet regulatory mandates	0	WCD	MUNICIPALITIES
Encourage non-MS4 municipalities to implement some or all of the 6 minimum control measures required of MS4 municipalities	2	WCD	MUNICIPALITIES, EACs
Work with municipalities to incorporate the non-structural BMPs identified in the PA Stormwater BMP Manual into municipal ordinances	2	WCD	WCP
Provide planning and technical assistance to municipalities and community organizations/agencies on stormwater management projects	0	WCD	WCP, PADEP
* These strategies are discussed in greater depth below			



## COUNTY WIDE MODEL STORMWATER ORDINANCE

PA Act 167 requires municipalities in the county to adopt or amend and implement a stormwater management ordinance and regulations in a manner consistent with the county-wide stormwater plan, the IWRP, and the provisions of Act 167. Each municipality must adopt the ordinances within six months of acceptance by DEP.

In the development of the IWRP, the Westmoreland Conservation District teamed with the WPAC and local experts to create the Model Stormwater Ordinance for county and municipal adoption. Beginning with PA DEP's Model Ordinance 2022, the model ordinance incorporates new sections authored by the District and inspired by other ordinances from across the state to provide innovative ways to address

the issues we face in Westmoreland County.

Innovative ideas to meet sustainability and incorporated into the model ordinance include clarification of what constitutes an impervious surface, what low impact development is, how regulated development activity is defined, what the scope of a small project is, and how stormwater management performance districts are designated to manage stormwater. Stormwater performance districts, established by the watershed modeling process, establish standards for design professionals regarding maximum release rates and water quality standards. The recommended spectrum of what is considered regulated development activity and what each municipality should choose to regulate is defined in the following table:

**Regulated Development Activity Table from the Model Stormwater Management Ordinance:**

SWM Plan Requirement	New Impervious Area for New and Redevelopment	Disturbed Area*	Next Steps
Exempt	0	Less than 1 acre	Comply with <b>Exemption</b> section of this ordinance
No-Harm	Up to [1,000] sf for urban OR [3,000] square feet for suburban/rural areas	Less than [3,000] sf urban OR [5,000] square feet for suburban/rural areas	Comply with <b>No-Harm</b> section of this ordinance
Waiver / Modification / Demonstrated Equivalency	Less than 1 acre, subject to municipal approval	Less than 1 acre	Comply with <b>Waiver / Modification / Demonstrated Equivalency</b> section of this ordinance
Small Project (per definition), refer to Appendix C	[1,000] [3,000] square feet to [10,000] square feet	[3,000] [5,000] square feet to [20,000] square feet	Submit <b>Small Project Site Plan</b> complete with all attachments
Stormwater Management Plan meeting the Ordinance requirements	Greater than [10,000] square feet if Exempt and Small Project criteria are not met, or if improvements do not meet No-Harm criteria	Greater than [20,000] square feet	Consult a qualified professional

The model ordinance takes a flexible approach to regulation so it can be tailored to each municipality, whether it is urban or rural, a township, borough or city, without causing specific hardships to any one municipality. Projects that may be exempt from regulation may be classified as 'no-harm', may request a waiver or modification, or may demonstrate equivalency by proposing a stormwater mitigation project on another property, are all defined as possible alternative measures in the ordinance.

As stormwater management relates to other regulations for development including erosion and sedimentation controls, stream encroachment and municipal development regulations, the model ordinance was written to achieve a unified site design approach, requiring all issues be addressed for all parties in one package. Small projects that may not be required to meet state standards can be defined by each municipality and a simple approach to a small project is included in the model ordinance.

The model ordinance includes optional sections on financial issues and guarantees for maintenance to help municipalities achieve sustainable stormwater infrastructure in their communities. Municipalities have the ability to define the statutory authority for the model ordinance prior to adoption to empower them in the regulation of land use activities, and to define the scope of penalties and appeals of any municipal judgements.

The complete Model Stormwater Ordinance can be found in the Appendices.

### WATERSHED PERFORMANCE DISTRICTS

Watershed Performance Districts are one of the outcomes of the Phase 2 Act 167 and IWRP. The result of the watershed modeling described in Chapter 5, and resultant release rate maps, the Performance Districts are integral to the regulations set by the model stormwater ordinance to manage stormwater in new and redevelopment across the county. The performance districts recommend release rates in developed watersheds to correct omissions from historic development and to protect our water resources into the future.

View the Watershed and Pollutant Modeling Task Matrix in the modeling methodology appendix for incomplete tasks.

Learn more in Chapter 5 Issues and Challenges.

## Turtle Creek Watershed Recommended Performance District Map

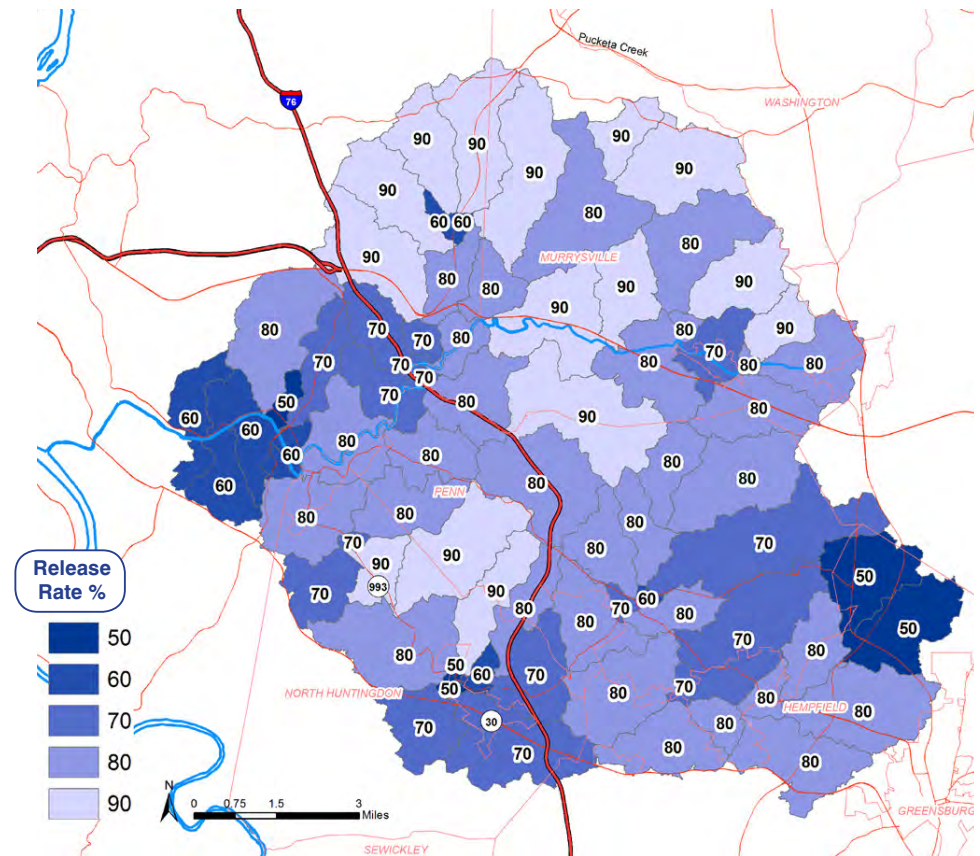

### UPDATING THE INTEGRATED WATER RESOURCES PLAN

Adopted by the County, the IWRP is required to be reviewed and updated, as necessary, every five years. The IWRP however, is a living document with an online presence and will be maintained by the District to stay up to date with stormwater issues, innovations in stormwater management, water resources monitoring, and more.

Learn more at [www.westmorelandstormwater.org](http://www.westmorelandstormwater.org).



## DECISION MAKING TOOL

The Westmoreland County IWRP includes a **web-based decision making flowchart tool** for all residents and visitors to the county to address water-related issues and problems and to answer the questions who, what, where, and why for all water resources. The online tool:

- Addresses all water resources and issues
- Streamlines design and regulatory process
- Is simple to use
- Integrates existing programs, studies, assessments, and resources
- Provides up to date information to the general public for use

The tool is an online decision-making flowchart questionnaire that will be kept current by the District and can be found on the IWRP website at [www.westmorelandstormwater.org](http://www.westmorelandstormwater.org). The tool addresses all water resources, the way they are used and how to find the appropriate information on the regulations, and use and management of each water resource. The tool guides decision making for land development, infrastructure and utility development, agriculture, and resource extraction.

The instructions and schematics for the decision making flowchart tool are in the Appendices.

## PARTNERSHIPS, SHARED SERVICES AND REGIONAL DECISION MAKING

Partnerships can produce stronger solutions to protect our water resources and to improve water quality for everyone. The Westmoreland County IWRP and Phase 2 Act 167 Plan are watershed-based and cross municipal lines. Municipalities are encouraged to work together to solve joint issues that plague their municipalities—most of all, stormwater issues.

Reimagining Our Westmoreland states: Service providers such as municipal public works departments offer necessary programs and services to residents and businesses; numerous providers can result in duplicative and inefficient service delivery. Benefits to consolidation may include cost savings and increased efficiency, and reducing administrative overhead and facility costs.

Common shared services include joint use agreements between school districts, park districts, fire districts, inter-municipal agreements between local governments for public works and other essential services, as well as intergovernmental cooperative purchase pooling by all public entities to maximize buying power.

- Mt. Pleasant Borough led the creation of the G14 (now G16) Conference, which brings municipal governments together from both Westmoreland and Fayette Counties (some that share watersheds) to explore inter-municipal agreements and opportunities for savings.
- Hempfield Township plows roads in Adamsburg Borough in exchange for indoor salt storage using a borough-owned storage shed, protecting the surrounding area from polluted runoff from the salt storage.
- A borough with limited staff and equipment can negotiate with a larger neighboring township to correct joint stormwater issues by supplying materials to be used by the neighboring public works department's labor and equipment at cost.

Many of the smaller municipalities could greatly benefit from consolidating into a single municipality or even sharing certain services. Funds, time, and other resources could be reserved for larger and more pressing projects. Unfortunately, the Commonwealth of Pennsylvania does not provide many resources for consolidation or shared services, creating an even larger barrier to the opportunity. The county's greatest role on this matter would be to advocate for better resources from the Commonwealth to help educate the municipalities.

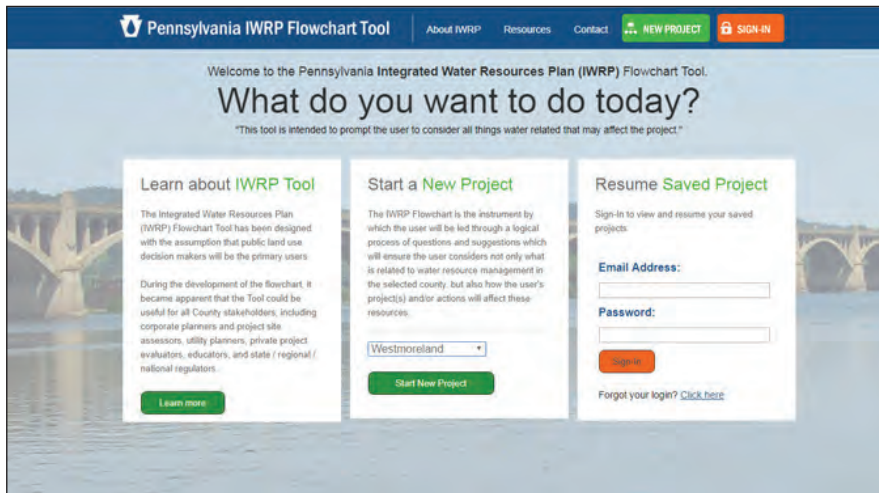

Cover page of the PaIWRP Decision-Making Flowchart Tool website: [www.paiwrp.com](http://www.paiwrp.com)

## CREATION OF STORMWATER AUTHORITIES

Many people are familiar with the ‘cost of living’—the cost of gasoline, housing, groceries, clothing—but there is a cost associated with excess stormwater as well. These costs are hidden but serious: eroded roads, flooded basements, backed-up sewers, waterlogged autos, and clogged culverts. Currently the costs of stormwater are borne by all taxpayers, with little regard to the actual source of the stormwater runoff or the true responsibility for the costs. The tax burden on citizens is a frequent topic of discussion, especially in an election year, but what alternative is there to funding stormwater? A more equitable method, one which has been implemented by certain Pennsylvania municipalities including the City of Philadelphia, is to charge a stormwater fee based on how much runoff is generated by a particular property. Such a fee is based on the impervious area of a site and adjusted according to factors such as a site’s location or stormwater infrastructure. The stormwater fee reflects the impact of a large parking lot as compared to that of a small house, charging the parking lot owner proportionally more than the homeowner. Philadelphia uses the revenue generated by the stormwater fee to address stormwater problems city-wide.



Photo from Pinterest

*A ‘green’ alley in Philadelphia, with streetside rain garden.*

To implement the benefits that stormwater management (and green infrastructure) systems provide for municipalities and their residents, substantial funding is required. Various mechanisms are used by municipalities around the country. As we listed in the funding initiatives

section of this chapter, many opportunities are available at the federal, state, and local levels to fund individual programs or projects but not necessarily to sustain the operation and maintenance of municipal and watershed stormwater management systems. A steady and reliable funding system is needed. Establishment of a county-wide, or perhaps watershed-wide, or municipal stormwater fee system would enable a direct source of funds to address our county’s numerous stormwater issues where they occur.

Like gas, electricity, water, and sewage, stormwater runoff can be managed by an authority and billed as a fee. Municipalities can realize many benefits from allowing authorities to handle stormwater permitting and management functions. To form a municipal authority, such as a stormwater authority, in Pennsylvania, a municipality must follow the procedures described in the Municipal Authorities Act, 53 Pa.C.S.A. § 5603. Municipal attorneys are advised to refer to this law when forming an authority.

For more information see this link to the Philadelphia Water Department’s site: <http://www.phila.gov/water/wu/stormwater/Pages/default.aspx>

## WATER RESOURCES MONITORING

Prior to undertaking the IWRP we relied heavily on information provided by national and state conservation organizations and on anecdotal evidence from users to judge the effectiveness of various measures.



Photo by Kathy Hamilton

*Green Infrastructure Specialist Matt Zambelli explains a rain garden data logger to District visitors.*



Now the District has up to 25 scientific monitors in place, gathering real-world data on rainfall, streamflow and various conservation practices on our campus and in the local community, measuring such things as soil moisture, volumetric water content, temperature, and electrical conductivity.

A real-time dashboard takes the information gathered, analyzes it, and makes it accessible in graphs, animations, trigger notes, and other formats. Historical data is also available for each sensor. This effort is important because it quantifies the effectiveness and benefits of conservation practices and so, we hope, will encourage even more installations.

The current scope of the monitoring program is extensive, and it provides insights into the hydrology of about half of Westmoreland County - where the water is, where it is going, its quality, and the major pollutants. It is available in a format that will be helpful to engineers, developers, architects, and others who may be looking to install a particular conservation practice

For more information see [www.westmorelandstormwater.org](http://www.westmorelandstormwater.org)

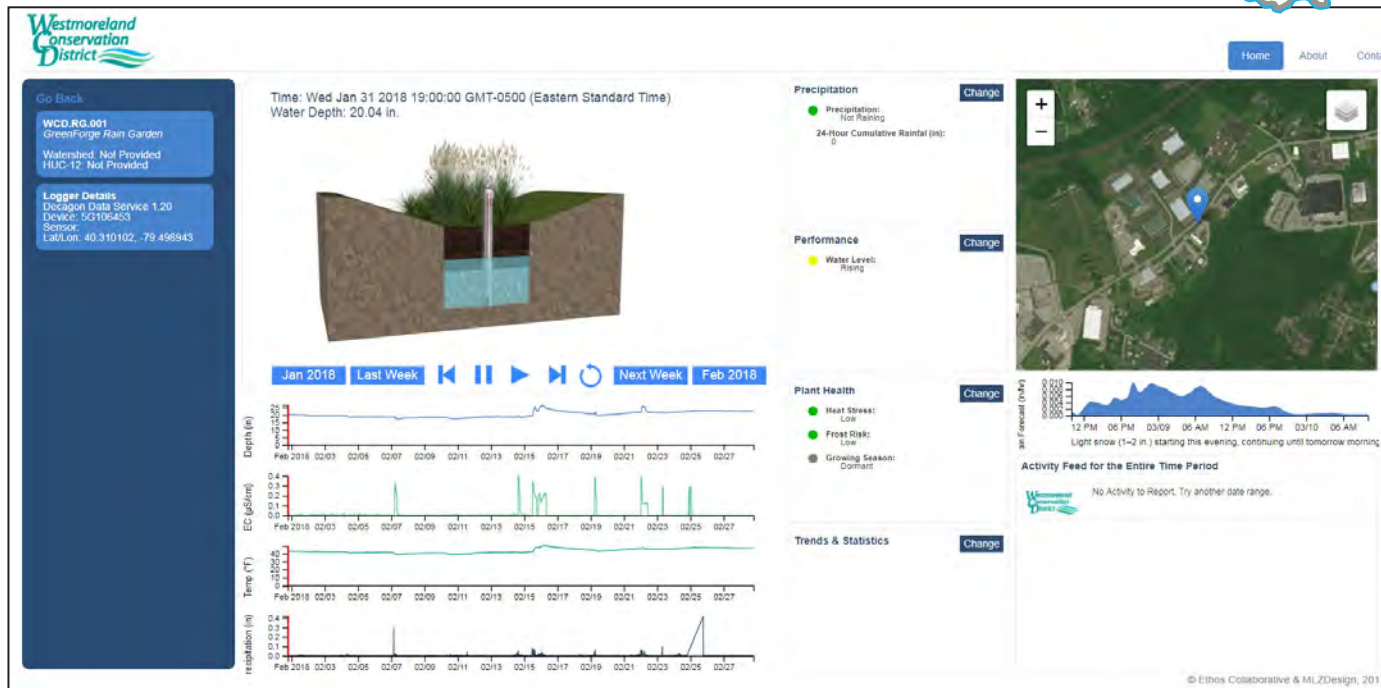
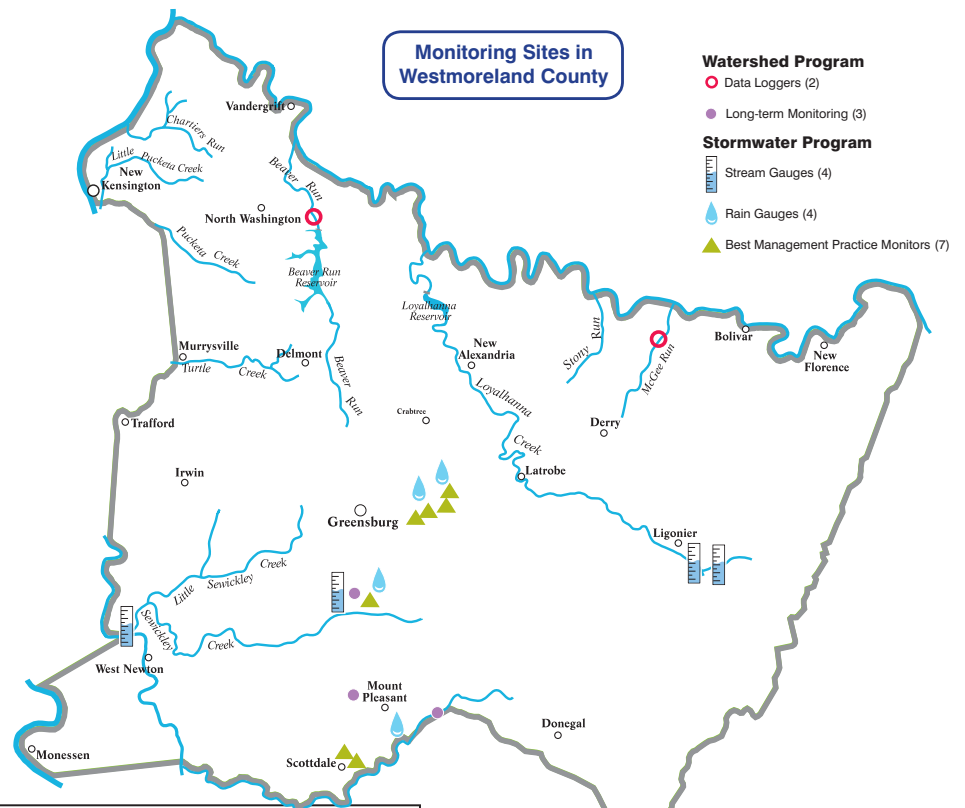

Left: Screen shot of Sensor Insights for a rain garden at GreenForge on the green infrastructure monitoring dashboard at [www.westmorelandstormwater.org](http://www.westmorelandstormwater.org)



## **BOARD OF DIRECTORS**

Ronald J. Rohall  
*Chairman*

Charles Duritsa  
*Vice Chairman*

Conrad Donovan  
*Treasurer*

Kim Edward Miller  
*Secretary*

Emil Bove, PLS

William Doney

County Commissioner Ted Kopas

Paul R. Sarver

Fred J. Slezak

## **Associate Directors**

Christopher Bova

Bruce J. Corna, Jr.

Reid Crosby

Alexander J. Graziani

John Hardiman

Karen Jurkovic

Larry Larese

John Lohr

Barbara D. McMillan

William Mihalco, PE

Robert Pore

Theresa Gay Rohall

John Turack

Keith Walters

## **STAFF**

Gregory M. Phillips  
*District Manager/CEO*

Anthony P. Quadro, Jr.  
*Assistant District Manager/Technical Programs Director/Forester*

Karen Barnhart  
*Fiscal Administrator*

Sandra Dzendzel  
*Director of Administration*

Mark Jackson  
*Visual Communications Specialist*

Sandra Donovan  
*Receptionist/Administrative Assistant*

## **Technical Staff**

James W. Pillsbury, MS, PE  
*Hydraulic Engineer*

Kathryn Hamilton, PLA  
*Landscape Architect/Stormwater Technician*

Matt Zambelli, PLA  
*Green Infrastructure Specialist*

Robert D. Cronauer  
*Watershed Program Manager*

Chelsea Walker  
*Watershed Specialist*

Christopher Droste, CESCO, CESC  
*Senior Erosion Control Specialist*

Jessica Kane  
*Erosion Control Specialist/Compliance Coordinator*

Daniel Griffith  
*Nutrient Management Specialist/Agricultural Conservation Technician*

Christie Sebek  
*Plans and Permits Coordinator*

Andrea Halfhill  
*Technical Programs Secretary*

Chelsea Gross  
*West Nile Virus Program Technician*

Alyssa Harden  
*AmeriCorps Service Member*

Kodie Rearick  
*AmeriCorps Service Member*

## **Educational Staff**

Janette Novak-Mitchell  
*Education Program Coordinator*

## **ADVISORY COMMITTEE TECHNICAL PROGRAMS**

Andrew Blenko, PE JD

Christopher Bova

Emil Bove, PLS

Lucien Bove, PE

Kevin Brett, PE

John Campfield, Esq.

Daniel Carpenter

Joseph Dietrick, PE PLS

Kathleen Fritz

Larry Gasparato

Donald Hixson, PE PLS

Greg Holesh, PE

Charles Kubasik

Brian Lawrence

Suzy Meyer, RLA

Dan Mikesic

William Mihalco, PE

Kim Edward Miller

Les Mlakar, Esq.

Ken Murin

Jason Rigone

William Roberts

Ronald Rohall

Thomas Sierzega

Doug Siler, PE

Tamira Spedalieri

## **Special Thanks to Westmoreland County Commissioners**

Gina Cerilli

Ted Kopas

Chuck Anderson



*For more information contact:*



**J. Roy Houston Conservation Center  
218 Donohoe Road  
Greensburg, PA 15601  
724-837-5271**

**email: [waterplan@wcdpa.com](mailto:waterplan@wcdpa.com)**

**[www.westmorelandstormwater.org](http://www.westmorelandstormwater.org)**



# WESTMORELAND COUNTY'S Integrated Water Resources Plan Appendix

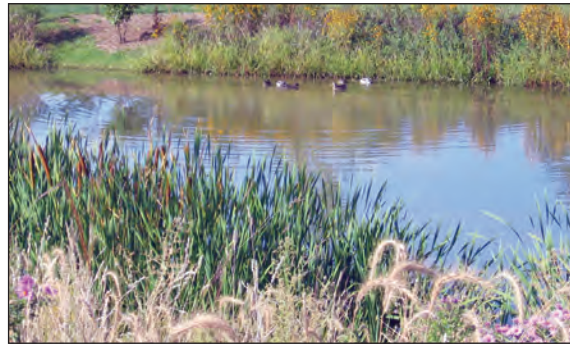

*For more information contact:*



**J. Roy Houston Conservation Center  
218 Donohoe Road  
Greensburg, PA 15601  
724-837-5271**

**email: [waterplan@wcdpa.com](mailto:waterplan@wcdpa.com)**

**[www.westmorelandstormwater.org](http://www.westmorelandstormwater.org)**



## APPENDIX

### Table of Contents

- A. Meeting the Act 167 Plan
- B. Model Stormwater Management Ordinance  
(found at [www.westmorelandstormwater.org](http://www.westmorelandstormwater.org))
- C. Decision Making Flowchart Tool  
(found at [www.westmorelandstormwater.org](http://www.westmorelandstormwater.org))
- D. BMP Portfolio & Maintenance Guidelines  
(found at [www.wcdpa.com](http://www.wcdpa.com))
- E. Homeowner's Guide to Stormwater  
Management/Toolkit  
(found at [www.wcdpa.com](http://www.wcdpa.com))
- F. Resource Library  
(found at [www.westmorelandstormwater.org](http://www.westmorelandstormwater.org))
- G. Watershed Plans
- H. Water Supply and Wastewater Treatment
- I. Watershed and Pollutant Modeling Methodology

## APPENDIX A

### Meeting the Act 167 Plan

- Phase I Act 167 Plan cover sheet, table of contents, & introduction
- Phase 2 Act 167 Plan requirements & how they are met by the IWRP
- PA DEP Act 167 Plan approval (pending)
- Westmoreland County IWRP letter of adoption (pending)



Westmoreland County Integrated Water Resources Plan

## Phase I Act 167 Plan Introduction

The entire plan may be found at

[http://spcwater.org/pdf/acts/WestmorelandCounty/WestmorelandCounty\\_Phase1\\_Act167.pdf](http://spcwater.org/pdf/acts/WestmorelandCounty/WestmorelandCounty_Phase1_Act167.pdf)



# Westmoreland County Department of Planning and Development

Greensburg, Pennsylvania

Act 167 Scope of Study for  
Westmoreland County  
Stormwater Management Plan



June 2010 ©





**PHASE 1 – SCOPE OF STUDY**

**TABLE OF CONTENTS**

**I. INTRODUCTION ..... 3**  
Purpose ..... 3  
Stormwater Runoff Problems and Solutions ..... 3  
Pennsylvania Storm Water Management Act (Act 167) ..... 4  
Act 167 Planning for Westmoreland County ..... 5  
Plan Benefits ..... 6  
Stormwater Management Planning Approach ..... 7  
Previous County Stormwater Management Planning and Related Planning Efforts  
..... 8

**II. GENERAL COUNTY DESCRIPTION..... 9**  
Political Jurisdictions ..... 9  
NPDES Phase 2 Involvement ..... 9  
General Development Patterns..... 10  
Land Use ..... 11  
Physiography ..... 11  
Soils ..... 12  
Water Resources ..... 12  
Floodplains..... 26  
Climate ..... 27

**III. ACT 167 PLANNING FOR WESTMORELAND COUNTY ..... 30**  
PADEP and Westmoreland County Agreement ..... 30  
Engineering Consultant Selection..... 30  
Survey Creation and Distribution..... 30  
Watershed Plan Advisory Committee (WPAC) ..... 30  
Watershed Plan Advisory Committee Meetings ..... 33

**IV. STORMWATER MANAGEMENT SURVEY RESULTS..... 34**  
Stormwater Problem Prioritization ..... 34  
Modeling Needs Assessment..... 35  
High Priority Goals for Phase 2 ..... 36

**V. PHASE 2 SCOPE DISCUSSION ..... 40**  
General Work Plan..... 40

**VI. REFERENCES ..... 44**

## **FIGURES**

- 1 Base Map
- 2 Stormwater Problem Areas
- 3 Watersheds to be Modeled in Phase 2

## **APPENDICES**

- A Stormwater Survey Form
- B Stormwater Survey Summary
- C Phase 2 Scope of Work
- D Phase 2 Cost Estimate
- E Proposed Phase 2 Schedule

## **ACKNOWLEDGEMENTS**

The preparation of this document was funded in part through a grant from the PA Department of Environmental Protection, Bureau of Watershed Management and the Westmoreland County Board of Commissioners



## I. INTRODUCTION

### *Purpose*

This report was prepared under and in accordance with a grant from the Pennsylvania Department of Environmental Protection (PADEP) for Westmoreland County to conduct a countywide Act 167 Stormwater Management Plan Phase 1. This report presents the results of the Phase 1 effort, which includes:

- A summary of County watershed characteristics
- An inventory of relevant problems
- A proposed Scope of Study, schedule and budget for completion of the Phase 2 Plan project.

### *Stormwater Runoff Problems and Solutions*

The water that runs off the land into surface waters during and immediately following a rainfall event is referred to as stormwater. In a watershed undergoing land use conversion or urban expansion, the volume of stormwater resulting from a particular rainfall event increases because of the reduction in pervious land area (i.e., natural land cover being changed to pavement, concrete, buildings, or unmanaged cropland). These surface changes can also substantially degrade stormwater runoff water quality, increasing the pollutant load to the rivers and streams. The alteration of natural land cover and land contours to residential, commercial, industrial, and crop land uses results in decreased infiltration of rainfall, an increased rate and volume of runoff, and increased pollutant loadings to surface watercourses.

As the population of an area increases, land development is inevitable. As land disturbance and development increases, so does the problem of dealing with the increased quantity and decreased quality of stormwater runoff. Failure to properly manage this runoff results in greater flooding, stream channel erosion and siltation, degraded water quality, as well as reduced groundwater recharge. The cumulative effects of development in some areas of a watershed can result in flooding of natural watercourses with associated costly property damages, and can have a negative impact on wastewater treatment plant operations. These impacts can be minimized if the land use and development incorporates appropriate runoff and stormwater management systems and designs.

Individual land disturbance/development projects have historically been viewed as independent or discrete events or impacts, rather than as part of a larger watershed process. This has also been the case when the individual land development projects are scattered throughout a watershed (and in many different municipalities). However, it is now being observed that the cumulative nature of individual land surface changes dramatically affects runoff and flooding conditions. These cumulative effects of development and land disturbance in some areas have resulted in flooding of both small and large streams with the associated property damages and, in some cases, loss of life. Therefore, given the distributed and cumulative nature of the land alteration

process, a comprehensive approach must be taken if a reasonable and practical management and implementation approach or strategy is to be successful.

### ***Pennsylvania Storm Water Management Act (Act 167)***

Recognizing the need to address this serious and growing problem, the Pennsylvania General Assembly enacted Act 167 of 1978. The statement of legislative findings at the beginning of the Pennsylvania Storm Water Management Act (Act 167) sums up the critical interrelationship among land development, accelerated runoff, and floodplain management. Specifically, this statement of legislative findings points out that:

1. Inadequate management of accelerated stormwater runoff resulting from development throughout a watershed increases flood flows and velocity, contributes to erosion and sedimentation, overtaxes the carrying capacity of streams and storm sewers, greatly increases the cost of public facilities to carry and control stormwater, undermines floodplain management and floodplain control efforts in downstream communities, reduces groundwater recharge, and threatens public health and safety.
2. A comprehensive program of stormwater management, including reasonable regulation of development and activities causing accelerated runoff, is fundamental to the public health, safety, and welfare and the protection of the people of the Commonwealth, their resources, and their environment.

The policy and purpose of Act 167 is to:

1. Encourage planning and management of storm water runoff in each watershed that is consistent with sound water and land use practices.
2. Authorize a comprehensive program of storm water management designated to preserve and restore the flood carrying capacity of Commonwealth streams; to preserve to the maximum extent practicable natural storm water runoff regimes and natural course, current and cross section of water of the Commonwealth; and to protect and conserve ground waters and groundwater recharge areas.
3. Encourage local administration and management of storm water consistent with the Commonwealth's duty as trustee of natural resources and the people's constitutional right to the preservation of natural, economic, scenic, aesthetic, recreational and historic values of the environment.

Until the enactment of Act 167, stormwater management had been oriented primarily towards addressing the increase in peak runoff rates discharging from individual land development sites to protect property immediately downstream. Management of stormwater throughout the state paid minimal attention to the effects on locations further downstream (frequently because they were located in another municipality) or to designing stormwater controls within the context of the entire watershed.

Stormwater management has also typically been regulated at the municipal level, with little or no design consistency (concerning the types or degree of storm runoff control to be practiced) between adjoining municipalities in the same watershed.



Act 167 changed this approach by instituting a comprehensive program of watershed stormwater management planning. The Act requires Pennsylvania counties to prepare and adopt stormwater management plans for each designated watershed within the County; and recent changes in PADEP Act 167 policy now provide for Act 167 planning efforts on a countywide basis. Perhaps most significantly, Act 167 plans are to be prepared in consultation with municipalities located in the County, working through a Watershed Plan Advisory Committee (WPAC). The plans are to provide technical standards and criteria throughout the County's watersheds for the management of stormwater runoff from new land development sites. The Act 167 Plan must now also address retrofits of existing sites to improve existing water quality impairments and existing sources of flooding problems.

The types and degree of controls that are prescribed in the stormwater management plan must be based on the development pattern and hydrologic characteristics of each individual watershed. The final product of the Act 167 watershed planning process is to be a comprehensive and practical implementation plan, developed with a firm sensitivity to the overall needs (financial, legal, political, technical, etc.) of the municipalities in Westmoreland County.

### ***Act 167 Planning for Westmoreland County***

Based on the above history and information, the countywide watershed planning process for Westmoreland County must be designed with the individual watershed characteristics in mind, as well as the resources (technical, political, and economic) of the County. This Phase 1 - Scope of Study presents the concept and approach that has been developed to meet these requirements, as well as the specific requirements of Act 167 for this countywide watershed stormwater management project.

The goal of Westmoreland County's Act 167 planning process is to provide a countywide comprehensive program for the planning and management of stormwater. With coordination from the sixty-five (65) municipalities in Westmoreland County, the resulting stormwater management ordinance will address stormwater related problems in critical areas throughout the County. Furthermore, all County municipalities must adopt the resulting stormwater management ordinance, or amend and implement ordinances and regulations as necessary to regulate development in a manner consistent with the proposed Plan and the provisions of Act 167. The stormwater management controls addressed in the stormwater management ordinance will collectively have a beneficial impact on the waters of Westmoreland County and those "problem" areas that presently remain unmanaged.

Westmoreland County has received Phase 1 Scope of Study funding from PADEP. The Phase 2 efforts will generate the final stormwater management plan and model ordinance.

## *Plan Benefits*

### 1. Consistency in Stormwater Management Planning, Regulation, and Implementation

The purpose and benefit of the study and implementation plan is to provide all of the municipalities in the County with an accurate and consistent implementation strategy and procedures for comprehensive stormwater management. Current stormwater management regulations, strategies, and enforcement criteria vary widely among the municipalities. Given the nature of storm runoff and its impacts, as described earlier in this document, a critical objective of sound stormwater management planning is to provide for consistency of implementation requirements throughout the watershed. Therefore, the primary objective of the technical study and planning process is to develop a technical and institutional support document to encourage and/or support the consistency of regulations for implementation of effective stormwater management based on watershed-wide consideration.

### 2. Integrated Stormwater Management Plan

Water resources are one integrated resource, connected through the hydrologic cycle. Stormwater runoff is a major component of this cycle. Surface water and groundwater are interconnected. The Westmoreland County Stormwater Management Plan will not only address water quantity or peak flows, but will also take a more holistic approach to watershed management by also evaluating the interaction between surface water and groundwater, where and how water quality concerns should be addressed, and how stormwater management (or lack thereof) affects stream bank erosion. The results will be a Plan to preserve and enhance Westmoreland County's water resources through proper stormwater management.

### 3. Usable Technical Information in GIS Format

The technical and institutional watershed planning approach recommended by the PADEP also provides the municipalities within this watershed with a considerable amount of usable technical information, such as a detailed watershed runoff simulation model, that can be used for numerous other associated purposes by participating municipalities. Consequently, the municipalities and the County will receive beneficial products that can be used for other planning and engineering purposes. For example, land use updates and environmental data management are functions that are necessary for effective planning in a watershed. The technical component of the plan, primarily the water resources geodatabase created for the watershed, will provide the County and municipalities with a tool to perform a range of environmental assessments, such as future water quality impact studies after the plan is completed.

### 4. Technical Information for Future Hydrologic and Hydraulic Analysis and Regulatory Activities

In addition, technical support information, provided as a part of watershed modeling efforts, can be useful in the analysis, design and regulatory permitting process for floodplain management and bridge replacement efforts. Further, the stream encroachment permit process, which involves the need to supply detailed



stream flow data as a part of the application process, can be developed more efficiently and cost-effectively using the calibrated watershed model.

The benefits of the watershed planning process are extensive, even beyond the important functions of developing comprehensive stormwater management strategies and ordinance provisions.

The plan will investigate and provide solutions to correct existing problems. Specifically, the plan will identify and summarize problem areas; provide much of the hydrology that will be required in the design of proposed solutions; provide potential conceptual solutions to correct these problems; and will specify possible funding streams for project implementation.

### ***Stormwater Management Planning Approach***

In order to implement countywide comprehensive planning and management of stormwater runoff, it was necessary to take a close look at all major watersheds within Westmoreland County during Phase 1. Since the goals of the Act itself depend on municipal coordination and participation to provide for the planning and management of stormwater throughout their respective municipality, it was necessary to get "buy-in", endorsement, and involvement from each municipality early in the planning process.

In order to initiate municipal level involvement in the overall development of the plan, a Watershed Plan Advisory Committee (WPAC) was formed and consists of the Westmoreland County Department of Planning and Development, municipalities, the Westmoreland County Conservation District, and other interested agencies or organizations. Two WPAC meetings were held during Phase 1 to introduce the planning process, to distribute map-based Stormwater Management Planning Surveys, and to review the Phase 1 Scope of Study document.

The development process for the stormwater management plan is as follows:

1. Phase 1 - Scope of Study - Establishing procedures used to prepare the Plan. These procedures are determined by an overall survey of:
  - Specific watershed characteristics and hydrologic conditions.
  - Stormwater related problems and significant obstructions.
  - Alternative measures for control.
  - Goals, objectives, solution strategies, and estimated costs for the Phase 2 Plan.
2. Phase 2 - The Plan - The technical assessment and development of the model ordinance that includes:
  - Watershed modeling and planning.
  - Development of technical standards and criteria for stormwater management.
  - Conceptual solutions to identify problem areas.

- Identification of administrative procedures for implementation of the plan.
- Adoption of Plan by Westmoreland County.
- Approval of Plan by PADEP.
- Adoption of stormwater management ordinances by all municipalities.
- Municipal implementation and enforcement of stormwater management ordinances.

*Previous County Stormwater Management Planning and Related Planning Efforts*

In addition, the following relevant documents have been prepared and will provide a valuable source of information for the development of the Plan:

1. Westmoreland County Comprehensive Plan, Westmoreland County Department of Planning and Development, January 2005
2. Westmoreland County Subdivision and Land Development Ordinance of the County of Westmoreland, Westmoreland County Department of Planning and Development, 2002
3. Sewickley Creek Watershed Conservation Plan, August 2003
4. Tubmill Creek Watershed Protection and Restoration Project, 1991
5. Westmoreland County Natural Heritage Inventory, September 1998
6. Kiski Conemaugh Basin Greenway Feasibility Study, 1999
7. Turtle Creek Watershed Act 167 Stormwater Management Plan, 1991
8. Macroinvertebrate Study, Loyalhanna Watershed Association, 2004-2005
9. Loyalhanna Watershed Assessment and Restoration Plan, Loyalhanna Watershed Association, 2006



Westmoreland County Integrated Water Resources Plan

# Phase 2 Act 167 Plan requirements & how they are met by the IWRP

## Westmoreland County Integrate Water Resources Plan

### MEETING THE ACT 167 PLAN

Required contents of Watershed Stormwater Plans under Sections 5(b) and 5(c) of Act 167  
Elements under Section 5(b)

- (1) A survey of existing runoff characteristics in small as well as large storms, including the impact of soils, slopes, vegetation and existing development;** is addressed in the following sections:

Chapter 2 Overview of Westmoreland County, esp natural features, climate, land use

Chapter 3 Westmoreland County Water Resources, esp. precipitation, water resources

Chapter 4 Impacts, esp. stormwater management

Chapter 5 Issues and Challenges, esp. priority watershed modeling reports for individual watershed areas of interest

- (2) A survey of existing significant obstructions and their capacities;** is addressed in the following sections:

Chapter 4 Impacts, esp. stormwater management

Chapter 5 Issues and Challenges, esp. watershed modeling of individual watershed areas of interest

- (3) An assessment of projected and alternative land development patterns in the watershed, and the potential impact of runoff quantity, velocity, and quality;** is addressed in the following sections:

Chapter 2 Overview of Westmoreland County, esp. county comprehensive plan

Chapter 5 Issues and Challenges, esp. watershed modeling of individual watershed areas of interest

Chapter 6 Westmoreland County's Action Plan, esp. county comprehensive plan

- (4) An analysis of present and projected development in flood hazard areas, and its sensitivity to damages from flooding or increased runoff;** is addressed in the following sections:

Chapter 3 Westmoreland County Water Resources, esp. floodplains

Chapter 4 Impacts, esp. stormwater management, flood hazard areas

Chapter 5 Issues and Challenges, esp. watershed modeling of individual watershed areas of interest

Chapter 6 Westmoreland County's Action Plan, esp. performance districts

- (5) A survey of existing drainage problems and solutions;** is addressed in the following sections:

Chapter 3 Westmoreland County Water Resources, esp. water resources

Chapter 4 Impacts, esp. stormwater management, impairments



Chapter 5 Issues and Challenges, esp. watershed modeling individual watershed areas of interest, conceptual projects and costs

Chapter 6 Westmoreland County's Action Plan, esp. local initiatives

- (6) A review of existing and proposed stormwater collection systems and their impacts;** is addressed in the following sections:

Chapter 3 Westmoreland County Water Resources, esp. water resources,

Chapter 4 Impacts, esp. stormwater management

Chapter 5 Issues and Challenges, esp. watershed modeling, conceptual projects and costs

- (7) An assessment of alternative runoff control techniques and their efficiency in the particular watershed;** is addressed in the following sections:

Chapter 5 Issues and Challenges, esp. watershed modeling, conceptual projects and costs

- (8) An identification of existing and proposed federal, state and local flood control projects located in the watershed and their design capacities;** is addressed in the following sections:

Chapter 3 Westmoreland County Water Resources, esp. water resources

Chapter 4 Impacts, esp. stormwater management

Chapter 5 Issues and Challenges, esp. watershed modeling, conceptual projects and costs

- (9) A designation of those areas to be served by stormwater collection facilities within a ten year period, an estimate of the design capacity and costs of such facilities, a schedule and proposed methods of financing the development, construction and operation of such facilities, and an identification of the existing or proposed institutional arrangements to implement and operate the facilities;** is addressed in the following sections:

Chapter 5 Issues and Challenges, esp. watershed modeling, conceptual projects and costs

Chapter 6 Westmoreland County's Action Plan, esp. local initiatives

- (10) An identification of floodplains within the watershed;** is addressed in the following sections:

Chapter 3 Westmoreland County Water Resources, esp. floodplains

Chapter 4 Impacts, esp. stormwater management

- (11) Criteria and standards for the control of stormwater runoff from existing and new development which are necessary to minimize dangers to property and life and carry out the purposes of this act;** is addressed in the following sections:

Chapter 5 Issues and Challenges, esp. watershed modeling, conceptual projects and costs

Chapter 6 Westmoreland County's Action Plan, esp. stormwater management ordinance, performance districts

**(12) Priorities for implementation of action within each plan;** is addressed in the following sections:

Chapter 6 Westmoreland County's Action Plan, esp. decision-making flowchart, stormwater management ordinance, performance districts, recommendations for implementation

**(13) Provisions for periodically reviewing, revising and updating the plan;** is addressed in the following sections:

Chapter 2 Overview of Westmoreland County, esp. county comprehensive plan  
Chapter 6 Westmoreland County's Action Plan, esp. recommendations for implementation

Elements under 5(c)

**(1) Contain such provisions as are reasonably necessary to manage stormwater such that development or activities in each municipality within the watershed do not adversely affect health, safety and property in other municipalities within the watershed and in basins to which the watershed is tributary;** is addressed in the following sections:

Chapter 6 Westmoreland County's Action Plan, esp. model stormwater ordinance, decision making flowchart

**(2) Consider and be consistent with other existing municipal, county, regional, and state environmental and land use plans;** is addressed in the following sections:

Chapter 6 Westmoreland County's Action Plan, esp. local initiatives, model stormwater ordinance, decision making flowchart, recommendations for implementation



Westmoreland County Integrated Water Resources Plan

PA DEP Act 167 Plan approval  
(pending)

Westmoreland County Integrated Water Resources Plan

# Westmoreland County IWRP

letter of adoption

(pending)



## APPENDIX B

# Model Stormwater Management Ordinance

The entire document may also be found at

<https://www.westmorelandstormwater.org>

**WESTMORELAND COUNTY**  
**MODEL STORMWATER MANAGEMENT ORDINANCE**  
**Implementing the Requirements of the Westmoreland County Stormwater Management /**  
**Integrated Water Resources Plan**

The following is based on the PADEP 2022 MODEL STORMWATER MANAGEMENT ORDINANCE (5/2016).

The Pennsylvania Storm Water Management Act (Act 167 of 1978) requires municipalities to “adopt or amend, and shall implement such ordinances and regulations, including zoning, subdivision and development, building code, and erosion and sedimentation ordinances, as are necessary to regulate development within the Municipality in a manner consistent with the applicable watershed stormwater plan and the provisions of this act”.

Federal regulations at 40 CFR § 122.34 require the use of ordinances by small MS4s to address 1) the prohibition of unauthorized non-stormwater discharges (MCM #3), 2) erosion and sediment controls for construction activities involving earth disturbances of one acre or more (or disturbances less than one acre if the construction activity is part of a larger common plan of development or sale that would disturb one acre or more) (MCM #4), and 3) post-construction stormwater management for new development and redevelopment projects (MCM #5). It is expected that MS4 municipalities will update existing ordinances to comply with the requirements of the MS4 program or, at a minimum, enact the DEP 2022 model ordinance by September 30, 2022.

DEP is directed under Act 167 to develop a model stormwater ordinance. DEP’s intention in publishing the 2022 Model Stormwater Management Ordinance is that its use will satisfy both Act 167 requirements, and MS4 regulatory requirements.

Text highlighted in [gray] is an indicator where municipal-specific information should be entered. Note – use of the Riparian Buffers and GI/LID requirements may be used toward meeting pollutant load reduction obligations of the NPDES permit if the permittee can demonstrate reductions from the optional practices.

It is recommended that the municipal solicitor review the entire Ordinance, and especially Article VIII – Enforcement Procedures and Remedies, and make any revisions necessary to ensure enforcement is pursued commensurate with applicable municipal codes. Appendix B to the Model Stormwater Management Ordinance is a recommended format for a landowner Operation and Maintenance agreement.



# **STORMWATER MANAGEMENT ORDINANCE**

**ORDINANCE NO.** \_\_\_\_\_

**MUNICIPALITY OF**

\_\_\_\_\_  
**WESTMORELAND COUNTY. PENNSYLVANIA**

**Adopted at a Public Meeting Held On**

\_\_\_\_\_, 20

**DRAFT JUNE 2019**  
**Westmoreland County**

**Model Stormwater Management Ordinance**

**ARTICLE I            General Provisions**

- §101.            *Short Title.*
- §102.            *Findings.*
- §103.            *Purpose.*
- §104.            *Statutory Authority*
- §105.            *Applicability.*
- §106.            *Repealer*
- §107.            *Severability*
- §108.            *Compatibility with Other Requirements.*
- §109.            *Erroneous Permit*
- §110.            *Prohibitions*
- §111.            *Liability Disclaimer.*

**ARTICLE II            Definitions.**

- §201.            *Interpretations and word usage*
- §202.            *Definitions of terms.*

**ARTICLE III            Stormwater Management Performance Standards.**

- §301.            *Stormwater Management Performance Districts.*
- §302.            *Regulated Development Activity Table*
- §303.            *Exemption from performance standards.*
- §304.            *No-Harm Option*
- §305.            *Waivers / Modifications / Demonstrated Equivalency*
- §306.            *Small Project*
- §307.            *General Standards*
- §308.            *Watershed Standards*
- §309.            *Design Criteria for Stormwater Management Facilities and BMPs*
- §310.            *Erosion and Sedimentation Controls.*
- §311.            *Water Obstructions and Encroachments*

**ARTICLE IV            Stormwater Management Plan Requirements.**

- §401.            *General Requirements.*
- §402.            *Stormwater Management Plan Contents.*
- §403.            *Other Permits/Approvals.*
- §404.            *Operation and Maintenance Program*
- §405.            *[Financial Guarantees ]*



**ARTICLE V Stormwater Management Plan Submission and Review Procedures.**

- §501. *Preapplication Phase.*
- §502. *Stormwater Management Plan Submission and Review*
- §503. *Status of Stormwater Management Plan after Approval.*
- §504. *Modification of Stormwater Management Plan*
- §505. *Inspection of Stormwater Management Facilities and BMPs*
- §506. *Record Drawings, Completion Certificate, and Final Inspection*

**ARTICLE VI Operation and Maintenance of Stormwater Facilities and BMPs**

- §601. *Operation and Maintenance Responsibilities.*
- §602. *Stormwater Facility and BMP Operations and Maintenance Plan Requirements*
- §603. *[Operations and Maintenance Agreement for Privately Owned Stormwater Facilities and BMPs]*
- §604. *[Municipality] Stormwater and BMP Operation and Maintenance Fund.]*

**ARTICLE VII Fees, Financial Guarantees and Dedication of Public Improvements.**

- §701. *Guarantee of Completion*
- §702. *Release of Completion Guarantee.*
- §703. *Default of Completion Guarantee*
- §704. *Dedication of Public Improvements.*
- §705. *Maintenance Guarantee.*
- §706. *Fee Schedule*

**ARTICLE VIII Enforcement Procedures and Remedies.**

- §801. *Right of Entry*
- §802. *Enforcement Generally*
- §803. *Preventative Remedies*
- §804. *Violations and Penalties.*
- §805. *Additional Remedies*
- §806. *Appeals*

**REFERENCES**

**APPENDICES**

- Appendix A** Stormwater Management Performance Districts (TBD)
- Appendix B** Example: Operation and Maintenance [Acknowledgment / Agreement]
- Appendix C** Small Project Stormwater Management Site Plan and Worksheet
- Appendix D** Stormwater Management Plan Checklist
- [Appendix E** Fees, Financial Guarantees]

**DRAFT June 2019**

**Westmoreland County**

**Model Stormwater Management Ordinance**

**ARTICLE I           General Provisions**

**§101.           *Short Title.***

This Ordinance shall be known and may be cited as the “[Municipality] Stormwater Management Ordinance.”

**§102.           *Findings. The [Governing body] of the [Municipality] finds that:***

- A. Stormwater runoff from lands modified by human activities threatens public health and safety by causing decreased infiltration of rainwater and increased runoff flows and velocities, which overtax the carrying capacity of existing streams and storm sewers, causes property damage and risk to public safety, and greatly increases the cost to the public to manage stormwater.
- B. Inadequate planning and management of accelerated stormwater runoff resulting from land development and redevelopment throughout a watershed can also harm surface water resources by changing the natural hydrologic patterns, accelerating stream flows (which increase scour and erosion of stream-beds and stream-banks thereby elevating sedimentation), destroying aquatic habitat and elevating aquatic pollutant concentrations and loadings such as sediments, nutrients, heavy metals and pathogens. Groundwater resources are also impacted through loss of recharge.
- C. [Municipality] is located in the [watershed] Watershed(s) and as such will endeavor to cooperate with other municipalities located in the watershed(s) to address issues of stormwater management, water quality, pollution and flooding.
- D. Non-stormwater discharges to municipal separate storm sewer systems can contribute to pollution of waters of the Commonwealth in the [Municipality].
- E. Stormwater can be an important water resource by providing groundwater recharge for water supplies and base flow of streams, which also protects and maintains surface water quality.
- F. Public education on the control of pollution of stormwater is an essential component in successfully managing stormwater.
- G. A comprehensive program of stormwater management, including reasonable regulation of land development and redevelopment causing loss of natural infiltration, is fundamental to the public health, safety, welfare, and the protection of the people of the [Municipality] and all the people of the Commonwealth, their resources, and the environment.
- H. The use of open space conservation, green infrastructure, low impact development (LID), and riparian buffers are intended to address the root cause of water quality impairment by using systems and practices which use or mimic natural processes to: 1) infiltrate and recharge, 2) evapotranspire, and/or 3) harvest and use precipitation near where it falls to earth. Green infrastructure practices, LID, and riparian buffers contribute to the restoration or maintenance of pre-development hydrology.
- I. Stormwater structures are considered vital infrastructure and can pose a significant hazard.



Outlets and waterways which carry stormwater shall be maintained free of obstructions to allow for non-restricted flow of stormwater to avoid impoundment of water.

- J. Occupancy and modification of floodplains shall be avoided wherever there is a practicable alternative to reduce long and short term adverse impacts in order to reduce the risk of flood loss, minimize the impact of floods on human safety, health and welfare, and to restore and preserve the natural and beneficial values served by floodplains.
- K. Federal and State regulations require certain municipalities to implement a program of stormwater controls. These municipalities are required to obtain a permit for stormwater discharges from their municipal separate storm sewer systems (MS4) under the National Pollutant Discharge Elimination System (NPDES). [[Municipality] is subject to MS4 requirements]
- L. The Westmoreland Conservation District (WCD) is a recognized regulatory agency with authority in the county and this municipality to regulate erosion and sediment controls and stormwater management related to land development activities. Because WCD's authority crosses municipal boundaries they are enabled to oversee environmental issues for the general benefit of all county residents.
- M. The Westmoreland County Integrated Water Resources Plan (2018) addresses all water resources and provides a decision making tool for development and redevelopment with respect to those resources including stormwater and its management. Refer to [www.paiwrp.com](http://www.paiwrp.com) and [www.westmorelandstormwater.org](http://www.westmorelandstormwater.org)

**§103. Purpose.**

The purpose of this Ordinance is to promote health, safety, and welfare within the [Municipality] and its watersheds by minimizing the harms and maximizing the benefits described in this Section of this Ordinance, through provisions designed to:

- A. Manage stormwater runoff impacts at their source by regulating activities that cause the problems, reduce runoff volumes and mimic natural hydrology.
- B. Maintain existing flows and quality of streams and watercourses.
- C. Prevent scour and erosion of streambanks and streambeds.
- D. Utilize and preserve the existing natural drainage systems as much as possible.
- E. Restore and preserve the natural and beneficial values served by streamside and waterbody floodplains.
- F. Focus on infiltration of stormwater, to maintain groundwater recharge, to prevent degradation of surface and groundwater quality and to otherwise protect water resources.
- G. Promote stormwater runoff prevention and emphasize infiltration and evapotranspiration through the protection and conservation of natural resource systems and the use of non-structural BMPs and other creative methods of improving water quality and managing stormwater runoff.
- H. Promote the use of green infrastructure in development and redevelopment where it can also improve stormwater management within the broader watershed in which the project is located.
- I. Meet legal water quality requirements under state law, including regulations at 25 Pa.Code,

Chapter 93.4a, to protect and maintain “existing uses” and maintain the level of water quality to support those uses in all streams, and to protect and maintain water quality in “special protection” streams.

- J. Provide review procedures and performance standards for stormwater planning and management.
- K. Provide for proper operations and maintenance of all permanent stormwater management BMPs that are implemented in the [Municipality].
- L. Provide a mechanism to identify controls necessary to meet the NPDES [and MS4] permit requirements, and to encourage infrastructure improvements that lead to separation of storm sewer systems from sanitary sewer systems.
- M. [Assist in detecting and eliminating illicit stormwater discharges into the [Municipality]'s separate storm sewer system.]

**§104. Statutory Authority**

- A. The [Municipality] is empowered to regulate land use activities that affect stormwater runoff by the authority of the Stormwater Management Act of October 4, 1978, P.L. 864 (Act 167), 32 P.S. Section 680.1, et seq., as amended, [and the Act of July 31, 1968, P.L. 805, No. 247, The Pennsylvania Municipalities Planning Code, as amended.]
- B. The [Municipality] is also empowered to regulate land use activities that affect stormwater runoff by the authority of [other [municipal code] or empowerment] or [Act of July 31, 1968, P.L. 805, No. 247, The Pennsylvania Municipalities Planning Code, as amended]

**§105. Applicability.**

- A. All regulated activities as defined by this ordinance are subject to regulation by this Ordinance.
- B. This Ordinance applies to any land development or regulated earth disturbance activities within the [municipality], and all stormwater runoff entering into the municipality's separate or combined storm sewer system from lands within the boundaries of the municipality.
- C. Earth disturbance activities and associated stormwater management controls are also regulated under existing State law and implementing regulations. This Ordinance shall operate in coordination with those parallel requirements; the requirements of this Ordinance shall be no less restrictive in meeting the purposes of this Ordinance than State law.

**§106. Repealer**

Any other ordinance provision(s) or regulation of the municipality inconsistent with any of the provisions of this Ordinance is hereby repealed to the extent of the inconsistency only.

**§107. Severability**

If any word, phrase, section, sentence, clause or part of this Ordinance is for any reason found to be unconstitutional, illegal or invalid, such unconstitutionality, invalidity or illegality by a court of competent jurisdiction, shall not affect or impair any of the remaining words, phrases, sections, sentences, clauses or parts of this Ordinance. It is hereby declared to be the intent of the [governing body] of the [municipality] that this Ordinance would have been adopted had



such unconstitutional, illegal or invalid word, phrase, section, sentence, clause or part thereof not been included herein.

**§108.           *Compatibility with Other Requirements.***

- A. Approvals issued and actions taken under this Ordinance do not relieve the applicant of the responsibility to secure required permits or approvals for activities regulated by any other code, law, regulation or ordinance. To the extent that this Ordinance imposes more rigorous or stringent requirements for stormwater management, the specific requirements contained in this Ordinance shall be followed.
- B. Conflicting provisions in other municipality ordinances or regulations shall be construed to retain the requirements of this Ordinance addressing state water quality requirements.

**§109.           *Erroneous Permit***

Any permit or authorization issued or approved based on false, misleading or erroneous information provided by an applicant is void without the necessity of any proceedings for revocation. Any work undertaken or use established pursuant to such permit or other authorization is unlawful. No action may be taken by a board, agency or employee of the Municipality purporting to validate such a violation.

**§110.           *Prohibitions***

Shall be consistent with PAG-13 NPDES General Permit for stormwater discharges from MS4 communities and as listed here.

**A.   Prohibited discharges**

- 1. No person in the [Municipality] shall introduce, permit or allow, or cause to introduce, permit or allow, stormwater discharges into the municipality separate storm sewer system which are not composed entirely of stormwater, except as permitted by this Ordinance, or
  - a. as provided in paragraph 2. below, or
  - b. discharges as authorized under a State or Federal permit.
- 2. Permissible discharges, based on a finding by the municipality that the discharge(s) do not significantly contribute to pollution to surface waters of the Commonwealth, can be discharged safely to a vegetated area or infiltration BMP, include but are not limited to:
  - a. Discharges from firefighting activities.
  - b. Potable water sources including dechlorinated water line and fire hydrant flushings.
  - c. Non-contaminated irrigation drainage from agricultural practices.
  - d. Routine external building washdown (which does not use detergents or other compounds).
  - e. Non-contaminated Air conditioning condensate.
  - f. Water from individual residential car, boat or other residential vehicle washing that does not use detergents or other compounds.
  - g. Springs.
  - h. Non-contaminated Water from basement or crawl space sump pumps.
  - i. Non-contaminated water from foundation or from footing drains.

- j. Flows from riparian habitats and wetlands.
  - k. Lawn watering.
  - l. Pavement washwaters where spills or leaks of toxic or hazardous materials have not occurred (unless all spill material has been removed) and where detergents are not used.
  - m. Dechlorinated swimming pool or splash pad discharges.
  - n. Non-contaminated groundwater.
3. In the event that the municipality determines that any of the discharges identified in paragraph 2. above significantly contributes to pollution of waters of the Commonwealth, or is so notified by DEP, the municipality will notify the landowner and/or the responsible person to cease the discharge.
  4. Upon notice provided by the municipality under paragraph 3. above, the discharger will have a [reasonable time] as determined by the municipality, to cease the discharge consistent with the degree of pollution caused by the discharge.
  5. Nothing in this Section shall affect, limit or alleviate a discharger's responsibilities under State or Federal law.

**B. Prohibited connections.**

The following sources, activities or connections are prohibited, except as provided in subsection A. 1. and 2. above:

1. Any drain or conveyance, whether on the surface or subsurface, which allows any non-storm water discharge including but not limited to, sewage, process wastewater and wash water, to enter the separate storm sewer system, and any connections to the storm drain system from indoor drains and sinks.
2. Any drain or conveyance connected from a commercial, industrial or other non-residential land use to the separate storm sewer system which has not been documented in plans, maps, or equivalent records, and approved by the [Municipality].
3. Drains carrying stormwater or groundwater shall not be connected to or discharge to any public or private sanitary sewer system or facility.

**C. Prohibited activities:**

1. A landowner may not alter the natural flow of surface water on his property by concentrating it in an artificial channel and discharging it upon lower land of his neighbor even though no more water is thereby collected than would naturally have flowed upon the neighbor's land in a diffused [shallow broad path or sheet flow] condition.
2. A landowner may not alter any BMPs, facilities or structures that were installed under the ordinance without written approval of the municipality.

**§111. Liability Disclaimer.**

- A. Neither the granting of any approval under the stormwater management provisions of this Ordinance, nor the compliance with the provisions of this Ordinance, or with any condition imposed by any public body of the [Municipality] or by a [Municipality] official, employee or consultant hereunder, shall relieve any person from any responsibility for damage to



person or property resulting therefrom, or as otherwise imposed by law, nor impose any liability upon the municipality for damages to persons or property.

- B. The granting of a permit which includes any stormwater management does not constitute a representation, guarantee or warranty of any kind by the municipality or WCD, or by an official or employee thereof, of the practicability or safety of any structure, use or other plan proposed and shall create no liability upon or cause of action against such public body, official or employee for any damage that may result pursuant thereto.

DRAFT

## ARTICLE II Definitions.

### **§201. Interpretations and word usage:**

For the purposes of this Ordinance, the terms and words used herein shall be interpreted as follows:

- A. Words used in the present tense include the future tense; the singular number includes the plural, and the plural number includes the singular; words of masculine gender include feminine gender; and words of feminine gender include masculine gender.
- B. The word “includes” or “including” shall not limit the term to the specific example but is intended to extend its meaning to all other instances of like kind and character.
- C. The words “shall” and “must” are mandatory; the words “may” and “should” are permissive.

### **§202. Definition of terms:**

**Act 167**– the Stormwater Management Act, Act of October 4, 1978, P. L. 864, No. 167, as amended by the Act of May 24, 1984, No. 63, 32 P.S. §§680.1 *et seq.* The Municipality is empowered to regulate land use activities that affect runoff and surface and groundwater quality and quantity by the authority of the Act, the “Storm Water Management Act.”

**Accelerated erosion** – the removal of the surface of the land through the combined action of human activities and the natural processes at a rate greater than would occur because of the natural process alone.

**Agricultural Activity** – Activities associated with agriculture such as agricultural cultivation, agricultural operation, and animal heavy use areas. This includes the work of producing crops and raising livestock including tillage, land clearing, plowing, disking, harrowing, planting, harvesting crops, or pasturing and raising of livestock and installation of Conservation Practices. Except for high tunnels that are exempt pursuant to the provisions of Act 15 of 2018, construction of new buildings or impervious areas is not considered an agricultural activity.

**Applicant** – a landowner, developer or other person who has filed an application for development or for approval to engage in any regulated earth disturbance activity at a project site in the [Municipality].

**Animal Concentration (heavy use) Areas** – A barnyard, feedlot, loafing area, exercise lots, or other similar animal confinement areas that will not maintain a growing crop, or where deposited manure nitrogen is in excess of crop needs, but excluding areas managed as pastures or other cropland, and pasture access ways, if they do not cause direct flow of nutrients to surface water or groundwater.

**BMP (best management practice)** – activities, facilities, designs, measures or procedures used to manage stormwater impacts from regulated development activities, to meet State water quality requirements, to promote groundwater recharge and to otherwise meet the purposes of this Ordinance. BMPs include, but are not limited to, infiltration, filter strips, low impact design, bioretention, wet ponds, permeable paving, grassed swales, forested buffers, sand filters and detention basins.



**Channel** – a perceptible natural or artificial waterway which periodically or continuously contains moving water or which forms a connecting link between two bodies of water. It has a definite bed and banks which confine the water.

**Chapter 102** – Title 25 Pa Code Chapter 102 Erosion and Sedimentation Control.

**Chapter 105** – Title 25 Pa Code Chapter 105 Dam Safety and Waterway Management.

**Combined sewer system** – A sewer system designed to serve as both sanitary sewer and storm sewer.

**CSO, Combined sewer overflow** – An intermittent flow or other untreated discharge from a municipal combined sewer system (including domestic, industrial and commercial wastewater and stormwater) which results from a flow in excess of the dry weather carrying capacity of the system.

**Conservation District** – the Westmoreland Conservation District (WCD), as defined in Section 3(c) of the Conservation District Law (3 P. S. § 851(c)) that has the authority under a delegation agreement executed with DEP to administer and enforce all or a portion of the regulations promulgated under 25 Pa. Code 102.

**Conservation Plan** – A plan written by an NRCS or SCS certified planner that identifies Conservation Practices and includes site specific BMPs for agricultural plowing or tilling activities and Animal Concentration Areas.

**Conservation Practices** – Practices installed on agricultural lands to improve farmland, soil and/or water quality which have been identified in a current Conservation Plan.

**Conveyance** –

- (a) Any structure that carries a flow.
- (b) The ability of a pipe, culvert, swale or similar facility to carry the peak flow from the design storm.

**Culvert** – a closed conduit for the free passage of surface drainage under a highway, railroad, canal or other embankment.

**DEP** – the Pennsylvania Department of Environmental Protection.

**Demonstrated equivalency** – A stormwater management project on an alternative site(s) within the same watershed as the proposed development that will provide equal or better achievement of the purpose of the Ordinance and will not substantially or permanently impair the appropriate use or development of adjacent property. Examples include streambank stabilization, creation or enhancement of riparian buffers, removal of existing impervious surfaces and establishment of ‘green’ easements, installation of stormwater management and water quality facilities, etc.

**Design criteria** –

- (a) Engineering guidelines specifying construction details and materials.

(b) Objectives, results or limits which must be met by a facility, structure or process in performance of its intended functions.

**Design storm** – see “storm frequency.”

**Detention** – the slowing, dampening or attenuating of runoff flows entering the natural drainage pattern or storm drainage system by temporarily holding water on a surface area in a detention basin or within the drainage system.

**Detention basin** – a pond, basin, reservoir or underground system constructed to impound or retard surface runoff temporarily.

**Developer** – a person that seeks to undertake or undertakes the activities associated with changes in land use or seeks to undertake or undertakes any regulated earth disturbance activities at a project site in the [Municipality]. The term “developer” includes, but is not limited to, the term subdivider, owner and builder, even though the person involved in successive stages of a project may change or vary.

**Development** – an “earth disturbance activity,” as herein defined and any activity, construction, alteration, change in land use or practice that affects stormwater runoff characteristics. The term also includes redevelopment.

**Development site** – the specific tract of land where any development or earth disturbance activities in the [Municipality] are planned, conducted, undertaken or maintained.

**Discharge** – the flow or rate of flow from a canal, conduit, channel or other hydraulic structure.

**Disturbed Area** – A land area where an earth disturbance activity is occurring or has occurred.

**Drainage** – in general, the removal of surface water from a given area commonly applied to surface water and ground water.

**Drainage area** – any of the following activities:

- (a) The area of a drainage basin or watershed, expressed in acres, square miles or other unit of area (also called “catchment area,” “watershed,” “river basin”).
- (b) The area served by a sewer system receiving storm and surface water, or by a watercourse.

**Earth disturbance activity** – a construction or other human activity which disturbs the surface of the land including, but not limited to, clearing and grubbing, grading, excavations, embankments, road maintenance, land development, building construction, oil and gas activities, well drilling, mineral extraction, and the moving, depositing, stockpiling, or storing of soil, rock or earth materials.

**Encroachment** – any structure or activity which in any manner changes, expands or diminishes, the course, current or cross-section of any watercourse, floodway or body of water.



**Erosion** – the process by which land, including channels, is worn away by water, wind, or chemical action.

**Erosion control** – the application of measures to reduce erosion of land surfaces.

**Erosion and sediment control plan** – a plan for a project site which identifies BMPs to minimize accelerated erosion and sedimentation of land.

**Existing Condition** – The dominant land cover during the 5-year period immediately preceding a proposed regulated activity.

**FEMA** – Federal Emergency Management Agency.

**Floodplain** – Any land area susceptible to inundation by water from any natural source or delineated by applicable FEMA maps and studies as being a special flood hazard area. Also includes areas that comprise Group 13 Soils, as listed in Appendix A of the Pennsylvania DEP Technical Manual for Sewage Enforcement Officers (as amended or replaced from time to time by DEP).

**Floodway** – The channel of the watercourse and those portions of the adjoining floodplains that are reasonably required to carry and discharge the 100-year flood. Unless otherwise specified, the boundary of the floodway is as indicated on maps and flood insurance studies provided by FEMA. In an area where no FEMA maps or studies have defined the boundary of the 100-year floodway, it is assumed--absent evidence to the contrary--that the floodway extends from the stream to 50 feet from the top of the bank of the stream.

**Forest Management/Timber Operations** – Planning and activities necessary for the management of forestland. These include conducting a timber inventory, preparation of forest management plans, silvi-cultural treatment, cutting budgets, logging road design and construction, timber harvesting, site preparation, and reforestation.

**Green Infrastructure** – Systems and practices that use or mimic natural processes to infiltrate, evapotranspire, or reuse stormwater on the site where it is generated.

**Ground cover** – materials and/or vegetation covering the ground surface.

**Ground water** – subsurface water occupying the saturation zone, from which wells and springs are fed.

**Groundwater recharge** – replenishment of existing natural underground water supplies.

**High Tunnel** – A structure which meets the following:

- (1) Is used for the production, processing, keeping, storing, sale or shelter of an agricultural commodity as defined in section 2 of the act of December 19, 1974 (P.L.973, No.319), known as the Pennsylvania Farmland and Forestland Assessment Act of 1974, or for the storage of agricultural equipment and supplies.

(2) Is constructed consistent with all of the following:

- i. Has metal, wood or plastic frame
- ii. When covered, has plastic, woven textile or other flexible covering
- iii. Has a floor made of soil, crushed stone, matting, pavers or a floating concrete slab

**Hot spots** - Areas where land use or activities generate highly contaminated runoff, with concentrations of pollutants that are higher than those typically found in stormwater (e.g., vehicle salvage yards and recycling facilities, vehicle fueling stations, fleet storage areas, vehicle equipment and cleaning facilities, vehicle service and maintenance facilities, and certain industrial/commercial activity areas).

**Hydrologic Soil Group (HSG)** – Infiltration rates of soils vary widely and are affected by subsurface permeability as well as surface intake rates. Soils are classified into four HSGs (A, B, C, and D) according to their minimum infiltration rate, which is obtained for bare soil after prolonged wetting. The NRCS defines the four groups and provides a list of most of the soils in the United States and their group classification. The soils in the area of the development site may be identified from a soil survey report that can be obtained from local NRCS offices or conservation district offices. Soils become less permeable as the HSG varies from A to D (NRCS1,2).

**Impervious surface** – a surface that prevents the infiltration of water into the ground. Impervious surfaces (or areas) shall include, but not be limited to: roofs, additional indoor living spaces, patios, garages, storage sheds, and similar structures; and any new streets or sidewalks. Decks, parking areas, gravel areas, and driveway areas are counted as impervious areas if they directly prevent infiltration.

**Infiltration** – any of the following activities:

- (a) The flow or movement of water through the interstices or pores of a soil or other porous medium.
- (b) The absorption of liquid by the soil.

**Land development** – any of the following activities:

- (a) The improvement of one lot or two or more contiguous lots, tracts or parcels of land for any purpose involving:
  - i. A group of two or more residential or nonresidential buildings, whether proposed initially or cumulatively, or a single nonresidential building on a lot or lots regardless of the number of occupants or tenure.
  - ii. The division or allocation of land or space, whether initially or cumulatively, between or among two or more existing or prospective occupants by means of, or for the purpose of streets, common areas, leaseholds, condominiums, building groups or other features.
- (b) A subdivision of land.

**Land disturbance** – any activity involving the changing, grading, transportation, fill and any other activity which causes land to be exposed to the danger of erosion.



**Low Impact Development (LID)** – Site design approaches and small-scale stormwater management practices that promote the use of natural systems for infiltration, evapotranspiration, and reuse of rainwater. LID can be applied to new development, urban retrofits, and revitalization projects. LID utilizes design techniques that infiltrate, filter, evaporate, and store runoff close to its source. Rather than rely on costly large-scale conveyance and treatment systems, LID addresses stormwater through a variety of small, cost-effective landscape features located on-site.

**Maintenance** – the upkeep necessary for efficient operation of physical properties.

**MS4** (municipal separate storm sewer system) - A conveyance or system of conveyances (including roads with drainage systems, municipal streets, catch basins, curbs, gutters, ditches, man-made channels, or storm drains):

- (a) Owned or operated by a State, city, town, borough, county, parish, district, association, or other public body (created by or pursuant to State law)...including special districts under State law such as a sewer district, flood control district or drainage district, or similar entity, or an Indian tribe or an authorized Indian tribal organization, or a designated and approved management agency under section 208 of the Clean Water Act that discharges into waters of the United States.
- (b) Designed or used for collecting or conveying stormwater;
- (c) Which is not a combined sewer; and
- (d) Which is not part of a Publicly Owned Treatment Works (POTW) as defined at 40 CFR 122.2.”

**Municipalities Planning Code** – Act 247 of 1968, as amended by Act 170 of 1988, 53 P.S. §10101 *et seq.*

**Municipality** – [Municipality], Westmoreland County, Pennsylvania.

**Native Vegetation** – Plant species that have historically grown in Pennsylvania and are not invasive species, controlled plants or noxious weeds as defined by PA DCNR, or PA Department of Agriculture.

**Natural stormwater runoff regime** – a watershed where natural surface configurations, runoff characteristics and defined drainage conveyances have attained the conditions of equilibrium.

**NPDES** – National Pollutant Discharge Elimination System, the Federal government's system for issuance of permits under the Clean Water Act, which is delegated to DEP in Pennsylvania.

**NRCS** – Natural Resources Conservation Service (previously Soil Conservation Service).

**Outfall** – “point source” as described in 40 CFR §122.2 at the point where the [Municipality] storm sewer system discharges to surface waters of the Commonwealth. Also, the point, location or structure where drainage discharges from a sewer, drain or other conduit as well as the conduit leading to the ultimate discharge point.

**Outlet control structure** – the means of controlling the relationship between the head water elevation and the discharge, placed at the outlet or downstream end of any structure through which water may flow.

**Overland flooding** – flooding that occurs for a variety of reasons all stemming from excessive stormwater runoff including too much rain in too little time, added impervious development, change in land use, malfunction or clogging of existing stormwater systems.

**Peak discharge** – The maximum rate of stormwater runoff from a specific storm event.

**Peak flow** – maximum flow.

**Pervious Area** – Any material or surface that allows water to pass through at a rate equal to or greater than natural ground cover.

**Pennsylvania DEP** – Pennsylvania Department of Environmental Protection.

**Performance standard** – a standard which establishes an end result or outcome which is to be achieved but does not prescribe specific means for achieving it.

**Person** – an individual, partnership, public or private association or corporation, firm, trust, estate, municipality, governmental unit, public utility or any other legal entity whatsoever which is recognized by law as the subject of rights and duties. Whenever used in any section prescribing or imposing a penalty, the term “person” shall include the members of a partnership, the officers, members, servants and agents of an association, officers, agents and servants of a corporation, and the officers of a municipality or county, but shall exclude any department, board, bureau or agency of the Commonwealth.

**Point source** – any discernible, confined and discrete conveyance including, but not limited to, any pipe, ditch, channel, tunnel, or conduit from which stormwater is or may be discharged, as defined in State regulations at 25 Pa.Code §92.1.

**Project site** – the specific area of land where any development or regulated earth disturbance activities in the [Municipality] are planned, conducted, undertaken or maintained.

**Qualified Professional** – Any person licensed by the Pennsylvania Department of State or otherwise qualified under Pennsylvania law to perform the work required by this Ordinance.

**Record drawings** – Drawings showing the stormwater management system of a site as built, created after the completion of construction and intended for use as a permanent record of the stormwater management system.

**Redevelopment** – earth disturbance activities on land which has previously been disturbed or developed.



**Regulated development activity** – Any earth disturbance activities or any activities that involve the change of land cover, alteration or development of land in a manner that may affect stormwater runoff as listed in the Regulated Development Activity table. This includes earth disturbance on any portion of, part, or during any stage of, a larger common plan of development. With regard to road maintenance activities the term only includes activities involving [1 acre] or more of earth disturbance. Refer to the Regulated Development Activity Table in Article III of this ordinance.

**Release Rate** – The percentage of existing conditions peak rate of runoff from a site or subarea to which the proposed conditions peak rate of runoff must be reduced to protect downstream areas.

**Release rate percentage** – the watershed factor determined by comparing the maximum rate of runoff from a subbasin to the contributing rate of runoff to the watershed peak rate at specific points of interest.

**Resource extraction** – any activity that involves withdrawing materials from the natural environment.

**Retention basin** – a pond, basin, usually enclosed by artificial dikes, that is used to retard stormwater runoff by temporarily storing the runoff and releasing it at a predetermined rate.

**Retention Volume/Removed Runoff** – The volume of runoff that is captured and not released directly into the surface waters of this Commonwealth during or immediately after a storm event.

**Return period** – the average interval in years over which an event of a given magnitude can be expected to recur.

**Riparian Buffer** – A permanent area of native vegetation including herbaceous material, shrubs and/or trees located adjacent to streams, lakes, ponds and wetlands.

**Road maintenance** – earth disturbance activities within the existing road cross-section, such as grading and repairing existing unpaved road surfaces, cutting road banks, cleaning or clearing drainage ditches and other similar activities.

**Runoff** – that part of precipitation which flows over the land.

**Runoff characteristics** – the surface components of any watershed which affect the rate, amount and direction of stormwater runoff. These may include, but are not limited to, vegetation, soils, slopes and manmade landscape alterations.

**SALDO** – Subdivision and land development ordinance

**Sediment** – mineral or organic solid material that is being transported or has been moved from its site of origin by air, water or ice and has come to rest.

***Sedimentation*** – the process by which mineral or organic matter is accumulated or deposited by moving water, wind or gravity.

***Separate storm sewer system*** – a conveyance or system of conveyances (including roads with drainage systems, municipal streets, catch basins, curbs, gutters, ditches, man-made channels or storm drains) primarily used for collecting and conveying stormwater runoff. Refer to MS4.

***Small project*** – Regulated development activities that, measured on a cumulative basis from 5 years prior to the application, create additional impervious areas of more than [1,000] square feet and less than [3,000] square feet or involve earth disturbance activity of an area less than [5,000] square feet and do not involve the alteration of stormwater facilities or water courses.

***State water quality requirements*** – as defined under State regulations– protection of designated and existing uses (See 25 Pa.Code, Chapters 93 and 96)–including:

- (a) Each stream segment in Pennsylvania has a “designated use,” such as “cold water fishery” or “potable water supply,” which are listed in 25 Pa.Code, Chapter 93. These uses must be protected and maintained, under State regulations.
- (b) “Existing uses” are those attained as of November 1975, regardless whether they have been designated in 25 Pa.Code, Chapter 93. Regulated earth disturbance activities must be designed to protect and maintain existing uses and maintain the level of water quality necessary to protect those uses in all streams, and to protect and maintain water quality in special protection streams.
- (c) Water quality involves the chemical, biological and physical characteristics of surface water bodies. After regulated earth disturbance activities are complete, these characteristics can be impacted by addition of pollutants such as sediment, and changes in habitat through increased flow volumes and/or rates as a result of changes in land surface area from those activities. Therefore, permanent discharges to surface waters must be managed to protect the stream bank, streambed and structural integrity of the waterway, to prevent these impacts.

***Storage facility*** – Any surface or sub-surface facility that stores stormwater runoff, see “detention basin” and “retention basin.”

***Storm frequency*** – the average interval in years over which a storm event of a given precipitation volume can be expected to occur. The magnitude and temporal distribution of precipitation from a storm event measured in probability of occurrence (e.g., a 5-year storm) and duration (e.g., 24 hours) used in the design and evaluation of stormwater management systems. Also see Return Period.

***Storm sewer*** – a sewer that carries intercepted surface runoff, street water and other drainage but excludes domestic sewage and industrial waste.

***Stormwater*** – drainage runoff from the surface of the land resulting from precipitation or snow or ice melt.



***Stormwater collection systems*** – natural or manmade structures that collect and transport stormwater through or from a drainage area to the point of final outlet including, but not limited to, any of the following conduits and appurtenant features, canals, channels, ditches, streams, culverts, streets and pumping stations.

***Stormwater management facility*** – a constructed measure for detention, retention, infiltration and water quality treatment of stormwater runoff.

***Stormwater management plan*** – the plan for managing stormwater runoff rate, volume and water quality as required by the Stormwater Management Act, 32 P.S. §680.1 *et seq.*

***Stormwater Management Performance District*** – an area designated by the Watershed Stormwater Performance District Map which includes standards for stormwater rate, volume and water quality. Refer to Appendix A.

***Subdivision*** – As defined in The Pennsylvania Municipalities Planning Code, Act of July 31, 1968, P.L. 805, No. 247, as amended.

***Swale*** – a low-lying stretch of land which gathers or carries surface water runoff.

***USDA*** – United States Department of Agriculture.

***Watercourse*** – a channel or conveyance of surface water, such as a run, stream or creek, having defined bed and banks, whether natural or artificial, with perennial or intermittent flow.

***Waters of the Commonwealth*** – any and all rivers, streams, creeks, rivulets, impoundments, ditches, watercourses, storm sewers, lakes, dammed water, wetlands, ponds, springs, and all other bodies or channels of conveyance of surface water, or parts thereof, whether natural or artificial, within or on the boundaries of this Commonwealth.

***Watershed*** – the entire region or area drained by a river or other body of water whether natural or artificial. A “designated watershed” is an area delineated by the Pennsylvania DEP and approved by the Environmental Quality Board for which Counties are required to develop watershed stormwater management plans.

***Watershed stormwater management plan*** – the plan for managing stormwater runoff throughout a designated watershed as required by the Pennsylvania Stormwater Management Act (Act 167), 32 P.S. §680.1 *et seq.*

***Wetland*** – Areas that are inundated or saturated by surface or groundwater at a frequency and duration sufficient to support, and that under normal circumstances do support, a prevalence of vegetation typically adapted for life in saturated soil conditions, including swamps, marshes, bogs, and similar areas

**ARTICLE III Stormwater Management Performance Standards.**

**§301. Stormwater Management Performance Districts.**

For purposes of stormwater management, the [Municipality] is located in the following [ Creek / River ] Watershed(s), which includes the Stormwater Management Performance District(s) shown on the map entitled ' [watershed] Performance District Map', which is hereby adopted as a portion of the Ordinance. For areas not covered by a stormwater performance district, the release rate shall be [80%] of the pre-development peak flow as set by the municipality. For more information refer to [www.westmorelandstormwater.org](http://www.westmorelandstormwater.org) .

**§302.** Preparation and implementation of a stormwater management site plan, unless exempted or otherwise deemed as no-harm, waived, modified, demonstrate equivalent, as a regulated activity shall not commence until written approval is issued by the municipality. Regulated Development Activity shall be as follows:

**[REGULATED DEVELOPMENT ACTIVITY TABLE]**

<b>SWM Plan Requirement</b>	<b>New Impervious Area for New and Redevelopment</b>	<b>Disturbed Area*</b>	<b>Next Steps</b>
Exempt	0	Less than 1 acre	Comply with <b>Exemption</b> section of this ordinance
[No-Harm]	Up to [1,000] sf for urban OR [3,000] square feet for suburban/rural areas	Less than [3,000] sf urban OR [5,000] square feet for suburban/rural areas	Comply with <b>No-Harm</b> section of this ordinance
Waiver / Modification / Demonstrated Equivalency	Less than 1 acre, subject to municipal approval	Less than 1 acre	Comply with <b>Waiver / Modification / Demonstrated Equivalency</b> section of this ordinance
Small Project (per definition), refer to Appendix C	[1,000] [3,000] square feet to [10,000] square feet	[3,000] [5,000] square feet to [20,000] square feet	Submit <b>Small Project Site Plan</b> complete with all attachments
Stormwater Management Plan meeting the Ordinance requirements	Greater than [10,000] square feet if Exempt and Small Project criteria are not met, or if improvements do not meet No-Harm criteria	Greater than [20,000] square feet	Consult a qualified professional

*Note: Items in [ ] are criteria to be set by the municipality as deemed appropriate.*

\*The above Table is only applicable for projects with earth disturbance less than 1 acre and that have not had cumulative impacts, within 5 years preceding the permit application date, that are in



excess of the square foot limits. Projects that propose greater than 1 acre of earth disturbance are subject to NPDES Permit requirements and will require a Stormwater Management Plan.

**§303. Exemption from performance standards.**

- A. The following regulated activities are specifically **exempt** from the Stormwater Management Plan preparation and submission requirements articulated in this Ordinance:
1. Agricultural activity limited to plowing or tilling activities, for animal concentrated (heavy) use areas provided the activities are performed according to the requirements of Chapter 102, or Conservation Practices being installed as part of the implementation of a Conservation Plan written by an NRCS or SCS-certified planner. This exemption does not include any other type of earth disturbance subject to NPDES permit requirements such as earth disturbance equal to or greater than one (1) acre.
  2. A high tunnel, if proof is provided that the high tunnel is exempt pursuant to the provisions of Act 15 of 2018. Such an exemption does not exempt high tunnels from other requirements applicable under Federal, State or municipal laws.
  3. Forest management and timber operations, provided the activities are performed according to the requirements of Chapter 102.
  4. Resource extraction activities, provided they are done in accordance with applicable PA DEP regulations.
  5. Roadway resurfacing and maintenance projects, which do not increase impervious area, and underground infrastructure projects are exempt from the provisions of this ordinance, provided the activities meet the requirements of all other municipal, state and federal requirements,
  6. Domestic landscaping and/or vegetable gardening.
  7. Voluntary Green Infrastructure (GI) or the retrofit of stormwater management infrastructure as conversion to green infrastructure BMPs to correct existing problems, that are solely intended to better manage runoff from existing development, are not part of new development or redevelopment, and that do not fall under the requirements of this or other development ordinances.
- B. The [Municipality] may deny or revoke any exemption pursuant to this Section at any time for any project that the [Municipality] believes may pose a threat to public health, safety, property or the environment.

**[§304. No-Harm Option]**

Applicants may request approval of a ‘no-harm option’ regarding stormwater management for their project. ‘No-harm option’ requests must meet the following criteria deemed appropriate by [Municipality]:

- A. Project located near or adjacent to [significantly larger body of water]

- B. Project able to discharge directly into [existing flood control feature]
- C. Project of a small size [<1,000] for urban, [<3,000] square feet for suburban and rural] of new impervious surface or [< 3,000] for urban, [<5,000] square feet for suburban and rural] of land use changes. Refer to the Regulated Development Activity Table in Article III this ordinance.
- D. Project will generate less than [0.5 cubic feet] per second for the [ten year storm] peak rate increase as compared to pre-development peak rate
- E. Project is not part of a larger development being ‘piecemealed’ in order to avoid stormwater management regulations
- F. Project is not part of a larger development which has grown ‘piecemeal’ over the past [five] years without SWM
- G. Project is a small percentage [<5%] of a much larger site and is incidental to the much larger site
- H. Project is not located in a neighborhood, watershed, or location where known stormwater problems exist, such as overland flooding like flooding of structures or roadways.
- I. Project does not discharge to a combined sewer
- J. Project will not degrade water quality of the receiving stream. Refer to the Westmoreland County Integrated Water Resources Plan [www.westmorelandstormwater.org](http://www.westmorelandstormwater.org) for maps of impaired streams to determine if the project area is not within an impaired stream corridor or provide documentation that further degradation will not occur.

To qualify for the ‘no-harm’ option, applicant may, at the request of the municipality, submit calculations, drawings, and details showing that the project meets the above criteria. Projects approved for the ‘no-harm’ option may be exempted from constructing all or some of the usual stormwater management practices regularly required for similar projects.

To be approved, no-harm requests must be reviewed and approved by both the [Municipality] engineer [and by the WCD], but final approval rests with [Municipality].

**§305.            *Waivers / Modifications / Demonstrated Equivalency***

- A. If the [Municipality], in conjunction with the municipality engineer, [WCD, or DEP as Applicable], determines that any requirement under this Ordinance cannot be achieved for a particular regulated activity, the municipality may, after an evaluation of alternatives, approve measures other than those in this Ordinance, subject to this Section paragraphs B, C and D. The request for a waiver, modification, or demonstrated equivalency shall originate with the Landowner, shall be in writing, include a study of downstream effects, and accompany the Stormwater Management Plan submission to the municipality. The request shall provide the facts on which the request is based, the provision(s) of the Ordinance involved and the proposed modification or demonstrated equivalency. The municipality engineer [and WCD] shall review the request to determine if it meets the requirements of the Ordinance including this Section, paragraphs B, C and D. If acceptable to the municipality [and WCD] and the regulated stormwater activity involving earth disturbance is less than one (1) acre, the municipality may grant the waiver or modification. If the regulated stormwater activity involving earth disturbance is equal to or greater than one (1) acre, the plan will be subject to the NPDES requirements of DEP.



- B. Waivers, modifications, or demonstrated equivalency of the requirements of this Ordinance may be approved by the municipality if enforcement will exact undue hardship because of unique physical circumstances or pre-existing site conditions peculiar to the land in question, provided that the modifications or demonstrated equivalency will not be contrary or detrimental to the public interest and shall achieve the intended outcome, and that the purpose of the Ordinance is preserved. Hardship must be due to such unique physical circumstances or pre-existing site conditions and not the circumstances or conditions generally created by the provisions of the Stormwater Management Ordinance; and there is no possibility that the property can be developed in strict conformity with the provisions of the Stormwater Management Ordinance. Cost or financial burden shall not be considered a hardship. Hardship cannot have been created by the landowner or developer. Modification or demonstrated equivalency shall not substantially or permanently impair the appropriate use or development of adjacent property(s) not under the Landowner's control. Modification or demonstrated equivalency may be considered if an alternative standard or approach will provide equal or better achievement of the purpose of the Ordinance.
- C. No waiver, modification or demonstrated equivalency of any regulated stormwater activity involving earth disturbance greater than or equal to one (1) acre may be granted by the Municipality unless that action is approved in advance by the Department of Environmental Protection (DEP) or the Westmoreland Conservation District (WCD).
- D. Applicants may request approval of a demonstrated equivalent stormwater activity for their project in lieu of performing traditional stormwater management. Demonstrated equivalent stormwater activity requests will be evaluated by the municipal engineer [and/or the WCD] on a case-by-case basis. Prior approval of a demonstrated equivalent stormwater activity on a site does not set a precedent for future approval of the same or other alternative activities on any site. The approval of a demonstrated equivalent stormwater activity does not excuse the applicant from following standard E&S and SWM practices as applicable on the original site.
1. Demonstrated equivalent stormwater activities shall only be approved when the following criteria are met:
    - a) Traditional stormwater management activities on the site are precluded by a particular site limitation, such as contaminated soil, steep slopes, existing buildings/infrastructure, combined sewer;
    - b) Construction of traditional stormwater management activities on the site would require extra permits or lead to excessive permitting activities and delays;
    - c) The site in question does not already have a stormwater management problem; and
    - d) The site in question is not already contributing to water quality problems in the receiving stream.
  2. Approvable demonstrated equivalent stormwater activities may include the following:
    - a) Restoration of an existing degraded wetland, stream channel, floodplain, or riparian buffer, including daylighting of a stream.

- b) Restoration, retrofit or upgrade an existing stormwater management feature (inadequate detention pond, for example).
  - c) Creation of new stormwater management features, especially green infrastructure, for a previously unmanaged site
  - d) Provide a water-based benefit to the public other than stormwater management (for example, extend a public sewer to an area not already served).
  - e) Treatment of abandoned mine drainage.
3. The proposal for demonstrated equivalency shall be accompanied by documentation or methodology quantifying the equivalency of the proposed project to what would have been originally required. Acceptable documentation or methodology may include use of the Worksheets and Checklist found in PA DEP NPDES permit application, Appendix D or approved method showing the proposed equivalency:
- a) Controls approximately the same amount of runoff volume as what would originally have been proposed
  - b) Improves approximately the same amount of runoff quality as would have been originally proposed
  - c) Is located within an impaired watershed or stream segment which will benefit from the proposed project. Impairment may include stream impairment, reduced stream buffer, and pollutant loading. Refer to the Westmoreland County Integrated Water Resources Plan at [www.westmorelandstormwater.org](http://www.westmorelandstormwater.org).
4. The demonstrated equivalent stormwater activity shall:
- a) Be constructed concurrently with the project for which it is being applied;
  - b) Be constructed according to plans approved by the municipality [and the WCD] including any erosion control and stormwater management practices as applicable;
  - c) Obtain all necessary permits;
  - d) Be located on land owned by or controlled by the applicant or by a cooperating public or private entity(s) (school, church, club, municipality, etc.);
  - e) Be protected by a perpetual easement or deed restriction, or landowner agreement;
  - f) Be located in the same general watershed as the project for which it is being applied; and
  - g) Have an Operation and Maintenance Plan (O&M) specifying who is responsible for what tasks.

**§306. Small Project**

- A. When a regulated development activity (refer to Table in Section 302 of this ordinance) creates impervious area between [3,000] and [10,000] square feet, or total earth disturbance between [5,000] and [20,000] square feet, the stormwater management requirements are as follows. Refer also to Appendix C.
- B. For new impervious surfaces, the first [1] [2] inch(s) of runoff shall be permanently



removed from the runoff flow, and shall not be released to waters of the Commonwealth. Removal options include reuse, evaporation, transpiration and infiltration.

- C. Facilities, to the greatest extent possible and subject to municipality approval, shall be designed to drain the permanently removed runoff volume in a period no greater than 72 hours. Runoff volumes in excess of [1] [2] inch(s) shall be safely conveyed to a stable vegetated area, natural watercourse, the curb or gutter line of roadway or existing storm collection/conveyance/control system as applicable.
- D. This method is exempt from the requirements of Section 402 of this ordinance.
- E. A Small Project Stormwater Management Plan must be submitted to the [Municipality] [and the WCD] and shall consist of the following items and related support material needed to determine compliance with Sections 307 to 311 of this ordinance. The applicant can also use protocols listed in Appendix C.
  - 1. Narrative: General description of proposed stormwater management techniques, including calculations, assumptions and criteria used in the design of the stormwater management facilities and BMPs, and construction specifications of the materials to be used for stormwater management facilities and BMPs.
  - 2. Stormwater Management Plan: Showing locations of all stormwater management facilities and BMPs, especially green infrastructure, limits of disturbance, including the type and amount of proposed impervious area, structures, roads, paved areas and buildings;
  - 3. Small Project Stormwater Management Worksheet;
  - 4. Signed [acknowledgement] [agreement] page for operation and maintenance of stormwater facilities and BMPs (Refer to Appendix B); and
  - 5. Erosion and Sediment Control Plan: including all reviews and letters of adequacy from the Conservation District.

### **§307. General Standards.**

- A. The Westmoreland County Integrated Water Resources Plan provides an online decision making tool to assist developers, designers, property owners in addressing all water resources during development and redevelopment and should be consulted. Refer to [www.paiwrp.com](http://www.paiwrp.com) and [www.westmorelandstormwater.org](http://www.westmorelandstormwater.org).
- B. The following provisions shall be considered the overriding performance standards against which all proposed stormwater control measures shall be evaluated and shall apply throughout the [Municipality].
  - 1. Any landowner and any person engaged in the alteration or development of land which may affect stormwater runoff characteristics shall implement such measures as are reasonably necessary to prevent injury to health, safety or other property. For alteration or development taking place in stages, the cumulative development must be used in determining conformance with this ordinance. Such measures shall include such actions as are required:
    - a. To assure that the maximum rate of stormwater runoff is no greater after development than prior to development activities for the 2-, 10- 25-, 50- 100-year storms. Rainfall data shall be obtained from NOAA Atlas 14 or other source approved by the municipality.





- C. The project plan shall specify permanent stormwater BMPs to be implemented, operated and maintained to meet legal water quality, rate and volume requirements.
- D. In order to protect and maintain water quality, additional stormwater runoff created by the development project must be captured, stored and treated. In addition, post construction stormwater infiltration of runoff must replicate preconstruction infiltration of runoff to the maximum extent possible with the exception of **hot spots**. As a minimum, this shall be a volume of additional runoff generated by a 2-year, 24 hour storm. Preferred BMP's for a **hot spot** include storm inlet filters, proprietary stormwater quality devices, underground detention tanks, detention ponds with forebays, tree planting, green roof. Permeable pavement, infiltration BMP's, and rain gardens are not recommended.
- E. In addition to the provisions set forth in paragraphs A. through C., inclusive, as set forth above, all regulated development activities within the [Municipality] shall be designed, implemented, operated and maintained to meet the purposes of this Ordinance, through these two elements:
  - 1. Erosion and sediment control during the earth disturbance activities (e.g., during construction).
  - 2. Water quality, rate and volume protection measures after completion of earth disturbance activities (e.g., post-construction stormwater management), including operations and maintenance.
- F. No regulated development activities within the [Municipality] shall commence until the requirements of this Ordinance are met.
- G. Erosion and sediment control during regulated development activities shall be addressed as required by this Ordinance.
- H. Post-construction water quality protection shall be addressed as required by this Ordinance. Operations and maintenance of permanent stormwater BMPs shall also be addressed as required by this Ordinance.
- I. All best management practices (BMPs) used to meet the requirements of this Ordinance shall conform to the State water quality requirements, and any more stringent requirements as determined by the [Municipality].
- J. Techniques described in the PA DEP Stormwater BMP Manual 2006 or most current edition are encouraged.

**§308. Watershed Standards**

- A. The stormwater management performance standards in this Ordinance are intended to implement the provisions, standards and criteria contained in the Pennsylvania Stormwater Management Act (Act 167), 32 P.S. §680.1 *et seq.* If there is any discrepancy between the provisions of this Ordinance and the provisions, standards and criteria of the Act, or if a stormwater management plan is subsequently approved and adopted by the appropriate governmental agency or body, then the provisions, standards and criteria of the current watershed plan shall govern.
- B. Management of stormwater runoff is key objective of 25 Pa.Code, Chapter 93, of the DEP Regulations, because runoff can change the physical, chemical and biological integrity of waterbodies thereby impacting rate, volume and water quality.
- C. The project plan shall describe how these rate, volume and water quality protection

requirements will be met. Infiltration BMPs shall be evaluated and utilized to the maximum extent possible to manage the net change in stormwater runoff generated so that post construction discharges do not degrade the physical, chemical or biological characteristics of the receiving waters. These BMPs may be used to satisfy all or part of the requirements found within this Ordinance.

D. Refer to the Stormwater Performance Districts outlined in Appendix A, and the Westmoreland County Integrated Water Resources Plan (IWRP) at [www.westmorelandstormwater.org](http://www.westmorelandstormwater.org) . The project plan shall describe how the proposed project will address performance standards, impairments, and pollutant loading found in the IWRP. For areas not covered by a stormwater performance district, the release rate shall be [80%] of the pre-development peak flow as set by the municipality.

**§309. Design Criteria for Stormwater Management Facilities and BMPs.**

**A. General Criteria.**

1. Applicants may select runoff control techniques, or a combination of techniques, which are most suitable to control stormwater runoff from the development site. Refer to the Acceptable Computation Methodologies table of this ordinance. All controls must be subject to approval of the [Municipality] engineer [and the WCD]. The [Municipality] engineer may request specific information on design and/or operating features of the proposed stormwater controls in order to determine their suitability and adequacy in terms of the standards of this Ordinance.
2. If the proposed development site is located in an impaired water shed according to Category 4 of the PA Integrated Water Quality Monitoring and Assessment Report, or in a watershed with a TMDL according to Category 5 of the same Report, the applicant shall identify the source and cause of impairment and shall propose, if required or applicable the use of BMPs to mitigate any impacts to the waters.
3. The applicant should consider the effect of the proposed stormwater management techniques on any special soil conditions or geological hazards which may exist on the development site. In the event such conditions are identified on the site, the [Municipality] engineer may require in depth studies by a competent geotechnical engineer. Not all stormwater control methods may be advisable or allowable at a particular development site.
4. The applicant shall consider the effect of the proposed stormwater management techniques on existing stream impairments and pollutant loading. Refer to the Westmoreland County Integrated Water Resources Plan (IWRP) at [www.westmorelandstormwater.org](http://www.westmorelandstormwater.org) .
5. The applicant shall consider existing conditions on the site for the prior [five] years to determine prevailing land use and impervious cover, and shall consider 20% of existing impervious cover as meadow for pre-existing conditions on redevelopment sites.
6. The stormwater management practices to be used in developing a stormwater management plan for a particular site shall be selected according to the following order of preference:



- a. Site planning for locating proposed buildings, impervious areas and grading which minimizes disruption of the natural site characteristics especially utilizing low impact development techniques.
  - b. Minimization of impervious areas and promotion of retentive grading.
  - c. Implementation of non-structural measures (refer to the PA DEP Stormwater BMP Manual 2006 or current edition).
  - d. Implementation of innovative / green infrastructure structural measures (refer to the PA DEP Stormwater BMP Manual 2006 or current edition).
  - e. Stormwater detention/retention structures.
7. Any BMP which is a dam, culvert, stream obstruction or encroachment or outfall as defined in 25 Pa.Code, Chapter 105, shall be designed according to the requirements in those regulations.
  8. Drainage easements shall be provided for all stormwater conveyance and BMPs serving multiple properties and not located within a public right of way. Easements shall include ingress and egress to a public right of way, and shall be recorded at the County with the final plan. Terms of easement shall prohibit excavation or placement of fill or structures and any alteration that may adversely affect the flow of stormwater within any portion of the easement.
  9. No person shall install, create, modify, remove, fill, landscape or otherwise alter or place any structure, soil, rock, material or vegetation in or on, or otherwise adversely affect, any stormwater management facility or any area within a stormwater easement without the written approval of the [Municipality] [and/or approval of the WCD].
  10. Persons engaged in land development activities shall provide the required [financial security, O&M Agreements] to the [municipality] as outlined in the Appendix B.

*B. Criteria for Stormwater Management Facilities and BMPs.*

1. If stormwater management facilities and BMPs are utilized for the development site, the facility(s) shall be designed such that post-development peak runoff rates from the developed site are controlled to those rates defined by a Stormwater Management Performance District for the 2-, 10-, and 25-, 50-, 100- year storm frequencies. Rainfall data shall be obtained from NOAA Atlas 14 or other source as approved by the municipality.
2. All stormwater management facilities and BMPs shall be equipped with outlet/overflow structures to provide rate discharge control for the designated storm frequencies. Provision shall also be made to safely pass the entire post-development 100-year storm without breaching or otherwise damaging the facilities, downstream or neighboring properties.
3. Release of stormwater flow from a development site must be to an existing stormwater conveyance or easement whether natural or man-made. Calculations and information shall be presented as to the ownership, responsible party, capacity, and stability of such conveyance. Release of 'sheet flow' as from a level spreader, will be permitted on a case-by-case basis as approved by the municipality [and WCD].
4. All stormwater management facilities and BMPs shall be designed to control

volume and water quality as defined by the Stormwater Management Performance District. Refer to Appendix A.

5. Shared stormwater management facilities and BMPs, which provide control of runoff for more than one development site within a single subarea may be considered and are encouraged. Such facilities shall meet the criteria contained in this Section. In addition, runoff from the development sites involved shall be conveyed to the facility in a manner that avoids adverse impacts (such as flooding or erosion) to channels and properties located between the development site and the shared storage facilities.
6. Where stormwater management facilities and BMPs will be utilized, multiple use facilities, such as wetlands, lakes, ballfields or similar recreational/open space uses are encouraged wherever feasible, subject to the approval of the [Municipality].
7. Other considerations which shall be incorporated into the design of the stormwater management facilities and BMPs include:
  - a. Inflow and outflow structures shall be designed and installed to prevent erosion and embankments, cuts, fills and bottoms of impoundment type structures should be protected from soil erosion.
  - b. Control and removal of debris both in the storage structure and in inlet or outlet devices shall be a design consideration.
  - c. Inflow and outflow structures, pumping stations and other structures shall be designed and protected, using safety benches, trash racks, energy dissipaters and other means to minimize safety hazards.
  - d. Access may be restricted as specified by [the provisions for fencing swimming pools] as found in the municipality Zoning Ordinance, and in appropriate instances such restriction of access may include [fencing in a minimum height of [6 feet]].
  - e. Interior slopes of storage ponds shall not exceed a ratio of three to one horizontal to vertical dimension with a combination of interior and exterior slopes not exceeding five. Steeper slopes may be approved by the municipality engineer if documented to be stable by a geotechnical analysis.
  - f. Landscaping shall be provided for the facility which stabilizes disturbed areas and preserves the natural and beneficial values of the surrounding area.
  - g. Facility shall be located to facilitate maintenance, considering the frequency and type of equipment that will be required.
  - h. Underground detention / retention / infiltration facilities shall be equipped with open grate inlet or manhole access to facilitate visual inspections.

### *C. Criteria for Collection/Conveyance Facilities.*

1. All stormwater runoff collection or conveyance facilities, whether storm sewers or other open or closed channels, shall be designed in accordance with the following basic standards:
  - a. All building sites shall use measures to provide drainage away from and around the structure in order to prevent any potential flooding damage as much as practical. Such measures shall include grading the surrounding lawn or pavement area so that it slopes away from the structure by a



- minimum of [5% slope] over a minimum distance of [10 feet]; raising the floor of the structure so that it is a minimum of [6 inches] above the predominate surrounding land elevation and above the designated floodplain elevation for those located within a floodplain; eliminating or waterproofing penetrations thru the structure's walls or foundation; constructing berms, curbs, or swales to divert surface water around the structure; arranging roof and area drains to carry water away from the structure.
- b. Developers proposing a land development or subdivision shall arrange internal drainage within the subdivision so that surface water is safely directed and channeled away from all structures within and adjacent to the development site.
  - c. Developers shall provide to all persons constructing a structure within a land development site, standards including drawings and specifications to ensure that those persons adhere to the general site plans and stormwater management plans for the development. Persons constructing a structure within a land development site shall submit to the municipal engineer [and WCD] drawings, calculations, and other information to show how they will meet the stormwater management requirements of the development site.
  - d. Lots located on the high side or low side of streets shall extend roof, trench and area drains to a stable vegetated area, natural watercourse, the curb or gutter line of roadway or storm collection/conveyance/control system (if applicable) in accordance with the approved stormwater management plan for the development site.
  - e. For all building sites and lots, the inclusion of rain barrels, rain gardens, drywells and other strategies for infiltration of roof runoff close to its source is encouraged.
  - f. Collection/conveyance facilities should not be installed parallel and less than [10 feet] from the top or bottom of an embankment, greater than or equal to [15 feet] height to avoid the possibility of failing or causing the embankment to fail, unless documented to be stable by a geotechnical analysis.
  - g. All collection/conveyance facilities shall be designed to convey the [25year storm] peak flow rate from the contributing drainage area and to carry it to the nearest suitable outlet such as a stormwater control facility, curbed street, storm sewer or natural watercourse.
  - h. Where drainage swales or open channels are used, they shall be suitably lined to prevent erosion and designed to avoid erosive velocities.
2. Wherever storm sewers are proposed to be utilized, they shall comply with the following additional criteria:
    - a. Where practical, designed to traverse under seeded and planted areas. If constructed within [10 feet] of road paving, walks or other surfaced areas, drains shall have a narrow trench and maximum compaction of backfill to prevent settlement of the superimposed surface or development.
    - b. Preferably installed after excavating and filling in the area to be traversed is

completed, unless the drain is installed in the original ground with a minimum of [3 feet] cover and/or adequate protection during the fill construction.

- c. *Designed.*
  - i. With cradle when traversing fill areas of indeterminate stability.
  - ii. With anchors when gradient exceeds 20 percent.
  - iii. With encasement or special backfill requirements when traversing under a paved area.
- d. Designed to adequately handle the anticipated stormwater flow and be economical to construct and maintain. The minimum pipe size shall be [15 inches] in diameter, with the exception of roof drains, foundation drains or similar conveyance.
- e. Drain pipe, trenching, bedding and backfilling requirements and appropriate grates, catch basins, stormwater inlets, manholes and other appurtenances shall conform to the requirements of the municipality and/or applicable PennDOT specifications, Publication 408.
- f. All corrugated metal pipe shall be polymer coated, and with paved inverts where prone to erode. Pipe within a municipality right-of-way shall be reinforced concrete pipe or high performance polypropylene pipe with a minimum diameter of [15 inches].
- g. Storm inlets and structures shall be designed to be adequate, safe, self-cleaning and unobtrusive and consistent with municipality standards with sufficient capture and conveyance capacity and spacing of inlets and cleanouts for maintenance.
- h. Where a proposed sewer or conveyance connects with an existing storm sewer or conveyance system, the applicant shall demonstrate that sufficient capacity exists in the downstream system to handle the additional flow.
- i. Storm sewer outfalls shall be equipped with energy dissipation devices to prevent erosion and conform with applicable requirements of the Pennsylvania DEP for stream encroachments (Section 7 of the Dam Safety and Encroachments Act, 32 P.S. §693.1, et seq., and the rules and regulations promulgated thereunder at 25 Pennsylvania Code §105.441-105.449).

#### D. *[Criteria for Riparian Buffers]*

1. If a riparian buffer is required by PA DEP as part of an NPDES permit, then DEP regulations will govern.
2. If a Riparian Buffer is used to meet stormwater management requirements it shall meet the following requirements:
  - a. In order to protect and improve water quality, a Riparian Buffer Easement may be created and recorded as part of any subdivision or land development that encompasses a Riparian Buffer.
  - b. Except as required by PA Code Title 25 Chapter 102, the Riparian Buffer



Easement shall may be measured to a minimum of 35 feet measured from the top of the nearest bank (on each side), or an average of 35 feet with no distance from top of bank less than 25 feet.

- c. Minimum Management Requirements for Riparian Buffers:
  - i. Existing native vegetation shall be protected and maintained within the Riparian Buffer Easement.
  - ii. Whenever practicable, invasive vegetation shall be actively removed and the Riparian Buffer Easement shall be planted with native trees, shrubs and other vegetation to create a diverse native plant community appropriate to the intended ecological context of the site.
  - iii. There shall be no earth disturbance beyond which is necessary to establish or maintain a planted buffer.
3. The Riparian Buffer Easement shall be enforceable by the municipality and shall be recorded in the appropriate County Recorder of Deeds Office, so that it shall run with the land and shall limit the use of the property located therein. The easement shall allow for the continued private ownership and shall count toward the minimum lot area a required by Zoning, unless otherwise specified in the municipal Zoning Ordinance.
4. Any permitted use within the Riparian Buffer Easement shall be conducted in a manner that will maintain the extent of the existing 100-year floodplain, improve or maintain the stream stability, and preserve and protect the ecological function of the floodplain.
5. Stormwater drainage pipes and all other linear utility lines as approved by the municipality shall be permitted within the Riparian Buffer Easement, but they shall cross the Easement in the shortest practical distance. Other stormwater management facilities and BMPs are not permitted within the Riparian Buffer Easement.
6. The following conditions shall apply when public and/or private recreation trails are permitted within Riparian Buffers:
  - a. Trails shall be for non-motorized use only.
  - b. Trails shall be designed to have the least impact on native plant species and other sensitive environmental features.
7. Septic drainfields and sewage disposal systems shall not be permitted within the Riparian Buffer Easement and shall comply with setback requirements established under 25 Pa. Code Chapter 73.

**§310. *Erosion and Sedimentation Controls.***

- A. No regulated development activities within the [Municipality] shall commence until approval by the [Municipality] and the Westmoreland County Conservation District of an erosion and sediment control plan for construction activities.
- B. Any earth disturbance activity of 5,000 square feet or more requires an erosion and sedimentation control plan under 25 Pa.Code §102.4(b). Refer to the PA DEP Erosion and Sediment Pollution Control Manual 2012 or most recent version.
- C. In addition, under 25 Pa.Code, Chapter 92, a DEP NPDES construction activities permit is required for regulated development activities.

- D. Evidence of any necessary permit(s) for regulated development activities from the appropriate DEP regional office or Westmoreland Conservation District must be provided to the municipality. The issuance of an NPDES construction permit (or permit coverage under the Statewide General Permit (PAG-2) may satisfy the requirements under subsection 1. upon review and approval by the municipality.
- E. A copy of the erosion and sediment control plan and any permit required by DEP or the [Municipality] shall be available at the project site at all times.

**§311.            *Water Obstructions and Encroachments***

- A. No regulated development activities which require Chapter 105 (Water Obstructions and Encroachment) permit from either PA DEP or Westmoreland Conservation District shall commence until all permits have received PA DEP or WCD approval, and municipal approval.
- B. Evidence of any necessary Chapter 105 permit from PA DEP / WCD shall be provided to the municipality.
- C. Proposed development shall avoid the long and short term adverse impacts associated with the occupancy and modification of floodplains as designated by FEMA, to the extent possible wherever there is a practicable alternative in order to reduce the risk of flood loss, minimize the impacts of floods on human safety, health and welfare, and restore and preserve the natural and beneficial values served by flood plains.
- D. Any proposed development found to be within the base floodplain of a waterway shall include the identification of impacts, an evaluation of practicable alternatives outside the floodplain, and when impacts cannot be avoided, the development of measures to minimize the impacts and restore and preserve the floodplain as appropriate. Findings shall be presented at a public meeting and a determination made by the [governing body] of the [municipality].



## ARTICLE IV Stormwater Management Plan Requirements.

### §401. General Requirements.

No development plan, subdivision plat or land development plan shall be approved; no permit authorizing construction or development issued; nor any earth disturbance activity subject to this Ordinance shall be initiated or undertaken unless and until a stormwater management plan for such activity is reviewed and approved in accord with the provisions of this Ordinance.

- A. No regulated development activities within the municipality shall commence until approval by the municipality of a stormwater management plan which demonstrates compliance with State water quality requirements after construction is complete. Refer to the Regulated Development Activity Table located in Article III of this ordinance.
- B. The stormwater management plan must be designed, implemented and maintained to meet State water quality requirements, and any other more stringent requirements as determined by the municipality.
- C. To control post-construction stormwater impacts from regulated development activities, State water quality requirements can be met by BMPs, including site design, which provide for replication of pre-construction stormwater infiltration and runoff conditions, so that post-construction stormwater discharges do not degrade the physical, chemical or biological characteristics of the receiving waters. As described in the DEP Comprehensive Stormwater Management Policy (#392-0300-002, September 28, 2002), this may be achieved by the following:
  1. *Infiltration*. Replication of pre-construction stormwater infiltration conditions.
  2. *Treatment*. Use of water quality treatment BMPs to ensure filtering out of the chemical and physical pollutants from the stormwater runoff.
  3. *Streambank and Streambed Protection*. Management of volume and rate of post-construction stormwater discharges, using detention / retention and other means, to prevent physical degradation of receiving waters (e.g., from scouring).
- D. In the absence of an existing stormwater conveyance or easement whether natural or man-made for release of stormwater flow from a development site, an easement must be provided. Information shall be presented as to the ownership, responsible party, and agreement for said easement.
- E. The stormwater management plan must meet DEP regulations that require municipalities to ensure design, implementation and maintenance of best management practices (“BMPs”) that control runoff from new development and redevelopment after regulated development activities are complete. These requirements include the need to implement post-construction stormwater facilities and BMPs with assurance of long-term operations and maintenance of those BMPs.
- F. Evidence of any necessary permit(s) for regulated development activities from WCD or the appropriate DEP regional office must be provided to the municipality. The issuance of an NPDES construction permit (or permit coverage under the Statewide General Permit (PAG-2) may satisfy the requirements of paragraph (A) above, after review and approval by the municipality.
- G. Appropriate sections from the municipality’s Subdivision and Land Development

Ordinance (SALDO), and other applicable local ordinances, shall be followed in preparing the SWM Plans. [In instances where the Municipality lacks subdivision and land development regulations, SWM Plans shall be reviewed and approved pursuant to the county's Subdivision and Land Development Ordinance (SALDO). If the county's SALDO does not have provisions for review and approval of SWM plans, the SWM plans must be reviewed and approved pursuant to the municipal SWM ordinance]

- H. The Municipality shall not approve any SWM Plan that is deficient in meeting the requirements of this Ordinance. At its sole discretion and in accordance with this Article, when a SWM Plan is found to be deficient, the municipality may either disapprove the submission and require a resubmission, or in the case of minor deficiencies, the Municipality may accept submission of modifications.
- I. *Professional Certification.* The stormwater management plan (including all calculations) must be prepared and sealed by a qualified professional with training and expertise in hydrology and hydraulics. Documentation of qualifications may be required by the [Municipality].

**§402. Stormwater Management Plan Contents.**

*General Format.* The stormwater management plan shall include a narrative and a set of plan drawings. Refer to checklist Appendix D.

- A. A narrative describing the overall stormwater management concept for the project.
  - 1. A determination of site conditions in accordance with the PA DEP Stormwater BMP Manual. A detailed site evaluation shall be completed for projects proposed environmentally sensitive areas, such as brownfields.
  - 2. *Runoff Calculations.* Stormwater runoff design calculations for determining pre- and post-development discharge rates, for designing proposed stormwater control facilities and to demonstrate that the maximum practicable measures have been taken to meet the requirements of this Ordinance, must be submitted with the stormwater management plan. All calculations shall be prepared using the methods and data prescribed by general requirements in Section [302]. Refer to the Acceptable Computation Methodologies table in Section III of this ordinance.
    - a. Runoff volume and rate shall be calculated according to generally accepted methods such as those listed under Stormwater Management Performance Standards, General Standards.
    - b. Detention/retention requirements, including volume, routing, etc. for BMPs shall be calculated using commonly acceptable standard method(s).
    - c. Water quality calculations shall be determined by using the PA DEP Stormwater BMP Manual 2006 or current edition Worksheets 12 and 13 [or acceptable alternative method by the municipality].
  - 3. Expected project time schedule for the installation of all temporary and permanent stormwater control measures and devices. If the development is to be constructed in stages, the applicant must describe how stormwater facilities and BMPs will be



sequentially installed to manage stormwater runoff safely during each stage of development.

4. The effect of the project (in terms of runoff rate, volumes, and water quality) on surrounding properties and aquatic features and on any existing stormwater conveyance system that may be affected by the project.
  5. If appropriate, the narrative should provide justification as to why any preferred stormwater management techniques, as listed in this Ordinance, are not proposed for use. Refer to the PA DEP Stormwater BMP Manual 2006 or most recent edition for list of acceptable management techniques.
  6. Operation and maintenance program and responsible party(s) for permanent stormwater facilities and BMPs. Refer to Section VI of this ordinance.
- B. The stormwater management plan drawings shall be drawn to a scale of not less than 1 inch equals 100 feet. All sheets shall contain a title block with name and address of applicant and designer, scale, north arrow, legend and date of preparation.
1. *Existing and Proposed Features.* The plan shall show the following:
    - a. *Watershed Location.* Provide a key map (using USGS Topo maps) showing the location of the development site within the watershed(s) and watershed subarea(s). On all site drawings, show the boundaries of the watershed(s) and subarea(s) as they are located on the development site and identify watershed name(s) and subarea number(s). Refer to Appendix A Watershed Performance District Maps.
    - b. *Floodplain Boundaries.* Identify 100-year floodplains on the development site (as appropriate) based on the municipality Flood Insurance Study maps.
    - c. *Natural Features.* Show all bodies of water (natural or artificial), watercourses (permanent and intermittent), swales, wetlands and other natural drainage courses on the development site, or which will be affected by runoff from the development.
    - d. *Soils.* Provide an overlay showing soil types and boundaries within the development site (consult WCD, SCS and U.S. Geological Survey for information).
    - e. *Contours.* Show existing and final contours at intervals of 2 feet; in areas with slopes greater than 15 percent, 5-foot contour intervals may be used.
    - f. *Land Cover.* Show existing and final land cover classifications, including existing and proposed improvements, as necessary to support and illustrate the runoff calculations performed.
    - g. *Drainage Area Delineations.* Show the boundaries of the drainage areas and points of interest employed in the runoff calculations performed.
    - h. *Utilities and easements.* Show any existing utilities, stormwater management or drainage controls and/or structures, such as sanitary sewers, water, gas, electric, telecommunications, storm sewers, swales, culverts, and any easements, which are located on the development site, or which are off site but may be affected by runoff from the development.
  2. *Proposed Stormwater Facilities and BMPs.* All proposed stormwater runoff control

measures must be shown on the plan including methods for collecting, conveying and storing stormwater runoff onsite, which are to be used both during and after construction. Erosion and sedimentation controls shall be shown in accordance with applicable [Municipality] [and WCD] requirements. The plan shall provide information on the exact type, location, sizing, design and construction of all proposed facilities and relationship to the existing watershed drainage system.

- a. If the development is to be constructed in stages, the applicant must demonstrate that stormwater facilities will be installed to manage stormwater runoff safely during each stage of development.
  - b. A schedule for the installation of all temporary and permanent stormwater control measures and devices shall be included in the narrative and shown on the site plan.
  - c. Operation and maintenance program and responsible party(s) for permanent stormwater BMPs. Refer to Section VI of this ordinance.
3. *Easements, Rights of Way, Deed Restrictions.* BMPS and stormwater management facilities that provide control for more than one lot shall be located on a separate dedicated lot or in an easement. All existing and proposed easements for any BMPs and stormwater management facilities and controls for access, inspections, maintenance, repair, preservation and use shall be shown on the plan and, if required, dedicated to the entity, association or person required. The easement and the purpose for the same shall be set forth on the plan and in the agreement required by the Ordinance.

**§403. *Other Permits/Approvals.***

A list of any approvals/permits relative to stormwater management that will be required from other governmental agencies (e.g., Chapter 102 Erosion and Sedimentation Control, PennDOT HOP, Chapter 105 Water Obstruction and Encroachment Permit from PA DEP) and anticipated dates of submission/receipt should be included with the stormwater plan submission. Copies of permit applications may be requested by the [Municipality] where they may be helpful for the plan review.

**§404. *Operation and Maintenance Program.***

The application shall contain a proposed operation and maintenance plan (O&M) for all stormwater control facilities in accordance with the following and as described in Article VI of this ordinance:

- A. Identify the proposed ownership entity (e.g., municipality, property owner, private corporation, homeowner's association or other entity).
- B. Include an operation and maintenance program for all facilities, outlining the type of maintenance activities, probable frequencies, personnel and equipment requirements and estimated annual maintenance costs.
- C. [Identify method of financing continuing operation and maintenance if the facility is to be owned by other than the [Municipality] or governmental agency. Refer to the Appendix.E]



D. [Submit any legal agreements required to implement the maintenance program and copies of the maintenance agreement as required by this Ordinance. Refer to the Appendix.E]

**§405. [Financial Guarantees.]**

[Submit financial guarantees in accordance with the provisions of this Ordinance. Refer to the Appendix.E]

DRAFT

**ARTICLE V Stormwater Management Plan Submission and Review Procedures.**

**§501. Preapplication Phase.**

- A. The Westmoreland County Integrated Water Resources Plan provides an online decision making tool to assist developers, designers, property owners in addressing all water resources during development and redevelopment and should be consulted. Refer to [www.paiwrp.com](http://www.paiwrp.com) for the decision-making tool and [www.westmorelandstormwater.org](http://www.westmorelandstormwater.org).
- B. Applicants should refer to the Westmoreland County Integrated Water Resources Plan (IWRP) located at [www.westmorelandstormwater.org](http://www.westmorelandstormwater.org), for mapping of impaired streams, riparian buffers and pollutant loading to determine appropriate BMPs to address sources of impairments.
- C. Before submitting the stormwater management plan, and any other plan required by a reviewing agency, applicants are urged to consult with the municipality, Westmoreland County Department of Planning and Development and Westmoreland Conservation District, and PennDOT where applicable, on the requirements for safely managing the development site in a manner consistent with the municipality ordinances, applicable watershed stormwater management plan and Federal and State requirements. These agencies may also be helpful in providing necessary data for the stormwater management plan.
- D. Applicants are encouraged to submit a sketch plan with a narrative description of the proposed stormwater management controls for general guidance and discussion with the municipality and other agencies.
- E. The pre-application phase is not mandatory; any review comments provided by the municipality or other agencies are advisory only and do not constitute any legally binding action on the part of the municipality or any County agency.

**§502. Stormwater Management Plan Submission and Review.**

- A. *Submission of Plans.* Stormwater management plan application shall be submitted with the preliminary and final subdivision/land development applications or if no subdivision or land development is involved, then with the application for development.

Copies of the SWM Site Plan shall be submitted to the following agencies as determined by [Municipality]:

- 1. [Two] copies to the municipality(ies).
  - 2. One copy to the municipal engineer (when applicable).
  - 3. One copy to the Westmoreland Conservation District (when applicable).
  - 4. One copy to the local Sanitary Authority (when applicable).
  - 5. One copy to the Westmoreland County Department of Planning and Development. (if applicable)
  - 6. One copy to the Westmoreland County Department of Public Safety / local emergency management coordinator (when applicable)
  - 7. One copy to DEP (when applicable)
- B. *Notification of Affected Municipalities.* The municipality shall notify municipalities upstream and downstream of the development site which may be affected by the stormwater runoff and proposed controls for the site. Copies of the plans will be made available to the affected municipalities upon request. Comments received from any



affected municipalities will be considered by the [Municipality] engineer and County agencies in their reviews.

- C. *Review by [Municipality] Engineer [and Westmoreland Conservation District (WCD)].* Stormwater management plans shall be reviewed by the municipality engineer [and WCD]. BMPs shall be shown on all stormwater management plans and erosion and sedimentation control plans, as applicable. At its discretion, the municipality [and/or WCD] may also engage other specialists in hydrology or hydraulics to assist with the stormwater management plan review. [The WCD will review the plan for general compliance with the watershed plan standards and criteria and watershed-wide impacts and, where appropriate, may consult with adjacent municipalities and counties for their comments. If the WCD review identifies the improper application of the watershed standards and criteria or the possibility of harmful impacts downstream from the development site's proposed stormwater management system, the applicant and municipality engineer will be notified so that the necessary modifications can be made to promote safe stormwater management.]

The municipality [and the WCD] shall notify the applicant in writing within 45 days whether the SWM site plan is approved or disapproved. If the SWM site plan involves a subdivision and land development plan, the notification shall occur within 90 days, unless the applicant is notified that a longer notification period is provided by other statute regulation or ordinance. If modifications are required, the review period may be extended by the municipality [and the WCD], in order for the applicant to address inadequacies.

- D. *[Municipality] Engineer Review.* The municipality engineer shall approve or disapprove the stormwater management plan based on the requirements of the [Municipality] ordinances, the standards and criteria of the watershed plan, applicable State and Federal requirements and good engineering practice. The [Municipality] Engineer shall submit a written report, along with supporting documentation, stating the reasons for approval or disapproval.
- E. *Status of the Engineer's Determination.* The approval/disapproval of the site's stormwater management plan by the municipality engineer shall be submitted to the [municipality] [governing body] for final action. Final approval of the plan rests with the municipality.
- F. *Permits Required From Other Governmental Agencies.* Where the proposed development requires a permit from the Pennsylvania DEP, PennDOT, or an erosion/sedimentation permit or Chapter 105 permit from the Westmoreland Conservation District, then final stormwater management plan approval shall be conditional upon receipt of such permits. However, no building permit shall be issued, nor construction or development started, until the permits are received and copies filed with the municipality.

**§503. *Status of Stormwater Management Plan after Approval.***

- A. Upon final stormwater management plan approval and receipt of all necessary permits, [financial guarantees and agreements,] the applicant may commence to install or

implement the approved stormwater management plan, BMPs plan or erosion and sedimentation plan controls.

- B. If site development or building construction does not begin within [2] years of the date of final approval of the stormwater management plan, then before doing so, the applicant shall re-submit the stormwater management plan, BMPs plan or erosion or sedimentation plan to verify that no condition has changed on the property, adjacent to the site or within the watershed that would affect the feasibility or effectiveness of the previously approved stormwater management controls. Further, if for any reason development activities are suspended for [2] years or more, then the same requirement for re-submission of the stormwater management plan shall apply.

**§504. *Modification of Stormwater Management Plan.***

If the request for a plan modification is initiated before construction begins, the stormwater management plan must be resubmitted and reviewed according to the procedures, contained in this ordinance.

- B. If the request for a plan modification is initiated after construction is underway, the [Municipality] Engineer [and / or the WCD] shall have the authority to approve or disapprove the modification based on field conditions; provided:
  - 1. The requested changes in stormwater controls do not result in any modifications to other approved municipality land use/development requirements (e.g., building setbacks, yards, etc.).
  - 2. The performance standards in this Ordinance are met. Notification of the Engineer's [and / or WCD's] action shall be sent to the [municipality] [governing body] which may issue a stay of the plan modification within 5 days and require the permittee to re-submit the plan modification for full stormwater management plan review in accordance with this ordinance.
- C. It shall be unlawful to, and no person shall, alter, replace, modify, landscape or remove, or otherwise adversely affect, any permanent stormwater management facilities, BMP controls, or any area within a stormwater easement or dedicated or designated area for stormwater facilities and BMPs required by an approved stormwater management plan, BMP operations and maintenance plan, or to allow the property to remain in a condition which does not conform to an approved stormwater management plan, BMP operations and maintenance plan, unless an exception is granted in writing by the municipality and/or approval is secured from all relevant agencies of the Commonwealth.

**§505. *Inspection of Stormwater Management Facilities and BMPs.***

- A. The municipality engineer or a designated representative shall inspect the implementation, construction, condition, operation and maintenance of the temporary and permanent stormwater management system and controls for the development site. The municipality or a designated representative shall have the right to temporarily locate on any BMP in the municipality such devices as are necessary to conduct monitoring and/or sampling the discharge from such BMP.
- B. The permittee shall notify the [municipal] engineer [and the WCD] 48 hours in advance of the completion of the following key development phases:



1. At the completion of preliminary site preparation including stripping of vegetation, stockpiling of topsoil and construction of temporary stormwater management control facilities.
  2. At the completion of rough grading but prior to placing topsoil, permanent drainage or other site development improvements and ground covers.
  3. During construction of the permanent stormwater facilities and BMPs at such times as specified by the municipality engineer.
  4. Completion of permanent stormwater management facilities and BMPs including established ground covers and plantings.
  5. Completion of final grading, vegetative control measures or other site restoration work done in accordance with the approved plan and permit.
- C. The Municipality [and/or WCD] may conduct inspections during construction as it deems appropriate.
- D. No work shall commence on any subsequent phase until the preceding one has been inspected and approved. If there are deficiencies in any phase, the municipality engineer [and/or WCD] shall issue a written description of the required corrections and stipulate the time by which they must be made.
- E. If, during construction, the contractor or permittee identifies any site condition, such as subsurface soil conditions, alterations in surface or subsurface drainage, which could affect the feasibility of the approved stormwater facilities, or erosion and sedimentation controls he/she shall notify the municipality engineer [and/or WCD] within 24 hours of the discovery of such condition and request a field inspection. The municipality engineer [and/or WCD] shall determine if the condition requires a modification of the stormwater management plan, BMPs plan or erosion and sedimentation control plan.
- F. In cases where stormwater facilities or erosion and sedimentation controls are to be installed in areas of landslide-prone soils or other special site conditions exist, the [Municipality] may require special precautions such as a geotechnical study, soil tests and core borings, full-time inspectors and/or similar measures. All costs of any such measures shall be borne by the permittee.

**§506. *Record Drawings, Completion Certificate, and Final Inspection***

- A. The developer shall be responsible for providing record drawings of all stormwater management facilities and BMPs as built and included in the approved Stormwater Management Plan. The record drawings and an explanation of any discrepancies with the construction plans shall be submitted to the Municipality [and/or WCD].
- B. The record drawing submission shall include a certification of completion signed by a qualified professional verifying that all permanent stormwater management facilities and BMPs have been constructed according to the approved plans and specifications. The latitude and longitude coordinates for all permanent stormwater management facilities and BMPs must also be submitted, at the central location of the BMPs. If any licensed qualified professionals contributed to the construction plans, then a licensed qualified professional must sign the completion certificate.
- C. After receipt of the completion certification by the Municipality, the Municipality [and/or WCD] may conduct a final inspection.

**ARTICLE VI                    Operation and Maintenance of Stormwater Facilities and BMPs**

**§601.                    *Operation and Maintenance Responsibilities.***

- A. The stormwater management plan for the development site shall contain an operation and maintenance plan prepared by the developer and approved by the [Municipality] [and/or WCD]. The operation and maintenance plan shall outline required routine maintenance actions and schedules necessary to insure proper operation of the facility(s).
- B. The stormwater management plan for the development site shall establish responsibilities for the continuing operation and maintenance (O&M) of all stormwater facilities and BMPs, consistent with the following:
  - 1. If a development consists of structures or lots which are to be separately owned and in which streets, sewers and other public improvements are to be dedicated to the municipality, stormwater facilities and BMPs should also be dedicated to and maintained by the municipality, except for those individual on-lot facilities and BMPs for privately owned structures.
  - 2. If a development site is to be held in single ownership or if sewers and other public improvements are to be privately owned, operated and maintained, then the operation and maintenance of stormwater facilities and BMPs should be the responsibility of the owner or private management entity.
  - 3. Person(s) responsible for operation and maintenance of stormwater facilities and BMPs shall be named with contact information provided.
- C. The [municipality] [governing body], upon recommendation of the municipality Engineer, shall make the final determination on the continuing maintenance responsibilities prior to final approval of the stormwater management plan. The [municipality] [governing body] reserves the right to accept the ownership and operating responsibility for any or all of the stormwater management facilities and BMPs.
- D. If the development site involves land located in more than one municipality, then the plan shall be reviewed by the municipality [and/or Conservation District] to determine if all activities both within and without the municipality meets the requirements of this Ordinance.
- E. Stormwater facilities and BMPs shall be inspected by the owner/responsible party named in the O&M plan on a [regular] basis as determined by the municipality or as approved in the O&M plan. Inspections may include photographs, written reports, measured drawings as necessary to document conditions of the facility(s) and the report shall be provided to the municipality [as requested.]

**§602.                    *Stormwater Facility and BMP Operations and Maintenance Plan Requirements.***

- A. No regulated development activities within the municipality will be considered complete until approval by the municipality of BMP operations and maintenance plan



which describes how the permanent (i.e., post-construction) stormwater facilities and BMPs will be properly operated and maintained.

- B. The following items shall be included in the BMP operations and maintenance plan:
1. Map(s) of the project area, in a form that meets the requirements for recording at the Office of the Recorder of Deeds of Westmoreland County, refer to the <http://www.wcdeeds.us/dts/> . The contents of the maps(s) shall include, but not be limited to:
    - a. Ownership and operation and maintenance responsibilities of stormwater facilities and BMPs.
    - b. Clear identification of the location and nature of permanent stormwater facilities and BMPs.
    - c. The location of the project site relative to highways, municipality boundaries or other identifiable landmarks.
    - d. Existing and final contours at intervals of 2 feet are required if the general slope of the site is less than 15 percent, and at vertical intervals of 5 feet if the general slope is equal to or greater than 15 percent.
    - e. Existing streams, lakes, ponds, or other bodies of water within the project site area.
    - f. Other physical features including flood hazard boundaries, sinkholes, streams, existing drainage courses, and areas of natural vegetation to be preserved.
    - g. The locations of all existing and proposed utilities, sanitary sewers, and water lines within 50 feet of property lines of the project site.
    - h. Proposed final changes to the land surface and vegetative cover, including the type and amount of impervious area that would be added.
    - i. Proposed final structures, roads, paved areas, and buildings.
    - j. A 15-foot wide access easement around all stormwater facilities and BMPs that would provide ingress to and egress from a public right-of-way.
  2. A description of how each permanent stormwater facilities and BMPs will be operated and maintained, and the identity of the person(s) responsible for operations and maintenance.
  3. The name of the project site, the name and address of the owner of the property, and the name of the individual or firm preparing the plan.
  4. A statement, signed by the landowner, acknowledging that the stormwater facilities and BMPs are fixtures that can be altered or removed only after approval by the municipality.
- C. Each stormwater facility and BMP shall be recorded with the County as permanent real estate appurtenances, and as deed restrictions or conservation easements that run with the land. Prior to final approval of the stormwater plan the property owner shall sign and record an O&M agreement for those facilities and BMPs. Refer to Article VIII of this ordinance.
- D. If the owner fails, refuses or neglects to maintain any stormwater facility and/or BMP, the municipality reserves the right to conduct maintenance work and charge and assess the owner [any and all costs, expenses incurred and fees] set by the municipality. The

municipality reserves the right to take enforcement actions for failure to perform required O&M. Refer to article VII of this ordinance.

- E. [A financial guarantee for timely installation and proper construction of stormwater facilities and BMPs shall be as specified in Article VII of this ordinance.]

**§603. [Operations and Maintenance Agreement for Privately Owned Stormwater Facilities and BMPs.]**

- A. Prior to final approval of the site's stormwater management plan the property owner shall sign and record a maintenance agreement covering all stormwater facilities and BMPs which are to be privately owned. The agreement (refer to Appendix B) shall stipulate that:
1. The owner, successors and assigns shall maintain all facilities in accordance with the approved maintenance schedule and shall keep all facilities in a safe and functional manner and consistent with the surrounding natural area.
  2. The owner, successors and assigns shall convey to the municipality easements and/or rights-of-way to assure access for periodic inspections by the municipality and maintenance, if required.
  3. The owner, successors and assigns shall keep on file with the municipality the name, address and telephone number of the person or company responsible for maintenance activities; and in the event of a change, new information will be submitted to the municipality within 10 days of the change.
  4. If the owner, successors and assigns fails to maintain the stormwater facilities and BMPs following due notice by the municipality to correct the problem(s), the municipality may perform the necessary maintenance work or corrective work and the owner shall reimburse the municipality for all costs.
- B. Other items may be included in the agreement where determined necessary to guarantee the satisfactory inspection and maintenance of all stormwater facilities and BMPs for a [10] year period. The maintenance agreement shall be subject to the review and approval of the municipality Solicitor and the [municipality] [governing body] and shall be in a form such as may be recorded in the Office of the Recorder of Deeds in the County in which the facility is located.
- C. The property owner shall sign an operations and maintenance agreement with the municipality covering all stormwater facilities and BMPs that are to be privately owned. The agreement shall be substantially the same as the agreement in the Appendix of this Ordinance.

**§604. [ [Municipality] Stormwater Facility and BMP Operation and Maintenance Fund. ]**

- A. Persons installing stormwater facilities or BMPs shall be required to pay a specified amount to the municipality stormwater facilities and BMPs fund to help defray costs of periodic inspections and maintenance expenses. The amount of the deposit shall be determined as follows:



1. If the stormwater facilities and/or BMPs are to be privately owned and maintained, the deposit shall cover the cost of periodic inspections performed by the municipality for a period of 10 years, as estimated by the municipality Engineer. After that period of time, inspections will be performed at the expense of the municipality.

2. If the stormwater facilities and/or BMPs are to be accepted, owned and maintained by the municipality, the deposit shall cover the estimated costs for maintenance and inspections for 10 years. The municipality Engineer will establish the estimated costs utilizing information submitted by the applicant.

3. The amount of the deposit to the fund shall be converted to present worth of the annual series values. The municipality engineer shall determine the present worth equivalents which shall be subject to the approval of the [governing body] of the [municipality].

- B. If stormwater facilities and BMPs are proposed that also serves as a recreation facility (e.g., ball field, lake), the municipality may reduce or waive the amount of the maintenance fund deposit based upon the value of the land for public recreation purposes, or the municipality may accept the maintenance fund deposit on behalf of the agency managing the recreation resource and make said fees available to the agency's maintenance department.
- C. If at some future time stormwater facilities and BMPs (whether publicly or privately owned) are eliminated due to the installation of storm sewers or other stormwater facilities and BMPs, the unused portion of the maintenance fund deposit will be applied to the cost of abandoning the facility and connecting to the storm sewer system or other facility. Any amount of the deposit remaining after costs of abandonment are paid will be returned to the depositor.

**ARTICLE VII [Fees, Financial Guarantees and Dedication of Public Improvements]**

**§701. *Guarantee of Completion.***

A. A completion guarantee or financial security in the form of a bond, cash deposit, cashier's check or other negotiable securities acceptable to the municipality shall provide for, and secure to the municipality, the completion of any improvements which may be required on or before the date fixed in the formal action of approval or accompanying agreement for completion of the improvements. The guarantee or security shall cover any and all stormwater management facilities, BMPs, erosion and sedimentation controls and other required improvements (collectively, "improvements") and shall be equal to 110% of the cost of completion estimated as of 90 days following the date scheduled for completion by the developer. Annually the municipality may adjust the amount of financial security by comparing the actual cost of the improvements which have been completed and the estimated cost for the completion of the remaining improvements as of the expiration of the 90<sup>th</sup> day after either the original date scheduled for completion or a rescheduled date of completion. Subsequent to said adjustment, the municipality may require the developer to post additional security in order to assure that the financial security equals said 110%. Any additional security shall be posted by the developer in accordance with this subsection.

B. The amount of the guarantee or financial security required shall be determined utilizing the provisions of [§509 (g) of the Municipalities Planning Code].

**§702. *Release of Completion Guarantee.***

The completion guarantee or financial security shall be returned or released upon written certification by the municipality Engineer or a designated agent that improvements and facilities have been installed and completed in accordance with the approved plan and specifications. The procedures for requesting and obtaining a release of the completion guarantee shall be [in a manner prescribed by the §510 of the Municipalities Planning Code].

**§703. *Default of Completion Guarantee.***

If improvements are not installed in accordance with the approved final plans, the [governing body] of the [municipality] may enforce any corporate bond or any security by appropriate legal and equitable remedies. If proceeds of such bond or other security are insufficient to pay the cost of installing or making repairs or corrections to all the improvements covered by said security, the [municipality] [governing body] may at its option install part of such improvements in all or part of the development and may institute appropriate legal or equitable action to recover the monies necessary to complete the remainder of the improvements. All proceeds, whether resulting from the security or from any legal or equitable action brought against the developer, or both, shall be used solely for the installation of the improvements covered by such security and not for any other municipality purpose.

**§704. *Dedication of Public Improvements.***

A. When streets, sanitary sewers, stormwater management facilities, BMPs, erosion and sedimentation controls or other required improvements in the development have



been completed in accordance with the final plans, such improvements shall be deemed private until such time as they have been offered for dedication to the [Municipality] and accepted by separate ordinance or resolution or until they have been condemned for use as a public facility. The municipality shall be under no obligation to accept such facilities or controls unless and until the municipality so determines that it is in the best interest of the municipality to do so.

- B. Prior to acceptance of any improvements or facilities, the municipality engineer shall inspect the same to ensure that the same are constructed in accordance with the approved plans and are functioning properly.
- C. The owner shall submit as-built plans for all facilities proposed for dedication.

**§705.           *Maintenance Guarantee.***

Prior to acceptance of any improvements or facilities, the applicant shall provide financial security to secure the structural integrity and functioning of the improvements. The security shall:

- A. Be in the form of a bond, cash, cashier's check or other negotiable securities acceptable to the municipality.
- B. Be for a term of 18 months.
- C. Be in an amount equal to 15 percent of the actual cost of the improvements and facilities so dedicated.

**§706.           *Fee Schedule.***

The [municipality] [governing body] may adopt by resolution, from time to time, a reasonable schedule of fees to cover the cost of pre-submitted and pre-construction meetings, plan reviews, inspections and other activities necessary to administer, monitor and enforce the provisions of this Ordinance. All fees shall be set in accordance with the applicable provisions of [the Municipalities Planning Code, 53 P.S. §10101 *et seq.*,] and any dispute over the fee amount shall be resolved in the manner prescribed by [the Municipalities Planning Code.]

**ARTICLE VIII      Enforcement Procedures and Remedies.**

**§801.            *Right of Entry.***

Upon presentation of proper credentials, duly authorized representatives of the [Municipality] may enter at reasonable times upon any property to inspect, investigate or ascertain the condition of the subject property in regard to an aspect related to stormwater management regulated by this Ordinance. Prohibitions and unreasonable delays in allowing the municipality access to a stormwater management facility pursuant to this Ordinance is a violation of this Ordinance. The failure of any person or entity to grant entry or to undertake any action which impedes or prevents entry is prohibited and constitutes a violation of this Ordinance. Unless in the event of an emergency, the municipality shall notify the property owner and/or developer within twenty-four hours prior to entry.

**§802.            *Enforcement Generally.* [requires solicitor review]**

In the event that the applicant, developer, owner or his/her agent fails to comply with the requirements of this Ordinance or fails to conform to the requirements of any permit a written notice of violation shall be issued. Such notification shall set forth the nature of the violation(s) and establish a time limit for correction of the violation(s). Upon failure to comply within the time specified, unless otherwise extended by the municipality, the applicant, developer, owner or his/her agent shall be subject to the enforcement remedies of this Ordinance. Such notice may require without limitation:

- A. Whenever the municipality finds that a person has violated a prohibition or failed to meet a requirement of this Ordinance, the municipality may order compliance by written notice to the responsible person. Such notice may require without limitation, any or all of the following:
  - 1. The performance of monitoring, analyses, and reporting.
  - 2. The elimination of prohibited connections or discharges.
  - 3. Cessation of any violating discharges, practices, or operations.
  - 4. The abatement or remediation of stormwater pollution or contamination hazards and the restoration of any affected property.
  - 5. Payment of a fine to cover administrative and remediation costs.
  - 6. The implementation of stormwater management measures or facilities.
  - 7. Operation and maintenance of stormwater management measures and/or facilities
  - 8. Assessment and payment of any and all costs and expenses relative to corrective measures taken or to be taken and reasonable costs, expenses and attorney fees incurred by the municipality in and related to enforcement and collection proceedings.
- B. Such notification shall set forth the nature of the violation(s) and establish a time limit for correction of these violations(s). Said notice may further advise that, if applicable, should the violator fail to take the required action within the established deadline, the work will be done by the municipality or designee and the expense thereof shall be charged to the violator.



- C. Failure to comply within the time specified shall also subject such person to the penalty provisions of this Ordinance. All such penalties shall be deemed cumulative and shall not prevent the municipality from pursuing any and all other remedies available in law or equity.

**§803.            *Preventative Remedies.* [requires solicitor review]**

- A. In addition to other remedies, the municipality may institute and maintain appropriate actions by law or in equity to restrain, correct or abate a violation, to prevent unlawful construction, to recover damages and to prevent illegal occupancy of a building or premises.
- B. In accordance with the Municipalities Planning Code, 53 P.S. §10101 *et seq.*, the municipality may refuse to issue any permit or grant approval to further improve or develop any property which has been developed in violation of this Ordinance.

**§804.            *Violations and Penalties.* [requires solicitor review]**

- A. Any person who has violated or knowingly permitted the violation of the provisions of this Ordinance or has refused, neglected or failed to perform any of the actions required pursuant to the Notice set forth in 2.A. above, upon conviction thereof in an action brought before a magisterial district judge in the manner provided for the enforcement of summary offenses under the Pennsylvania Rules of Criminal Procedure, shall be guilty of a summary offense, and shall be sentenced to pay a fine of not less than \$100.00 nor more than \$1,000.00 for each violation, plus costs, together with reasonable attorney fees; and, in default or failure of full and timely payment of such fine, costs and fees, to a term of imprisonment not to exceed ninety (90) days or to a term of imprisonment to the extent permitted by law for the punishment of violations of summary offenses, whichever is less. Each day that a violation of this Ordinance continues or each Section of this Ordinance which shall be found to have been violated shall constitute a separate offense. No judgment shall commence or be imposed, levied or be payable until the date of the determination of a violation by the magisterial district judge. Each day that a violation of this Ordinance continues or each Section of this Ordinance which shall be found to have been violated shall constitute a separate offense.
- B. If the defendant neither pays nor timely appeals the judgment, the [Municipality] may enforce the judgment pursuant to applicable rules of civil procedure.
- C. Each day that a violation continues shall constitute a separate violation unless the magisterial district judge further determines that there was a good faith basis for the person violating this Ordinance to have believed that there was no such violation. In such case there shall be deemed to have been only one such violation until the fifth day following the date of the district justice's determination of the violation; thereafter each day that a violation continues shall constitute a separate violation.
- D. All judgments, costs and reasonable attorney fees collected for the violation of this Ordinance shall be paid over to the municipality.

- E. The court of common pleas, upon petition, may grant an order of stay, upon cause shown, tolling the per diem fine pending a final adjudication of the violation and judgment.
- F. Nothing contained in this Section shall be construed or interpreted to grant to any person or entity other than the municipality, the right to commence any action for enforcement pursuant to this Section.
- G. Each day that a violation of any provision of this Ordinance shall constitute a separate violation and be deemed a public nuisance.

**§805. Additional Remedies.** [requires solicitor review]

In addition to the above remedies, the municipality may also seek the remedies and penalties under applicable Pennsylvania statutes, or regulations adopted pursuant thereto including, but not limited to, the Stormwater Management Act, 32 P.S. §§693.1 *et seq.*, and the erosion and sedimentation regulations, 25 Pa.Code, Chapter 102. Any activity conducted in violation of this Ordinance or any Pennsylvania approved watershed stormwater management plan may be declared a public nuisance by the municipality and abatable as such.

**§806. Appeals.** [requires solicitor review<sup>1</sup>]

A. Appeals.

- 1. Any person aggrieved by a decision of the Municipality or any of its authorized persons or agencies, may appeal in writing said decision to the [governing body] within thirty (30) days of any decision. Any appeal

---

<sup>1</sup> As a comment to the municipality and municipal solicitor, please review the following: A Municipality without a Zoning Ordinance may use the language in the model ordinance concerning appeals. A Municipality with a Zoning Ordinance would be required to comply with the following sections of the MCP. Section 909.1. of the MPC, entitled "Jurisdiction", provides that

(a) The zoning hearing board shall have exclusive jurisdiction to hear and render final adjudications in the following matters:

(9) Appeals from the determination of the zoning officer or municipal engineer in the administration of any land use ordinance or provision thereof with reference to sedimentation and erosion control and storm water management insofar as the same relate to development not involving Article V or VII applications.

(Meaning that the Zoning Hearing Board's jurisdiction on E&S and SWM matters must relate to the Official Map of the municipality (found in Article IV of the MPC) or its Zoning Ordinance (found in Article VI of the MPC).)

Section 901.1(b).6 of the MPC specifies that the governing body or the planning commission, where designated, shall have exclusive jurisdiction to render final adjudications from the determination of the zoning officer or the municipal engineer in the administration of any land use ordinance or provisions thereof with reference to sedimentation and erosion control and stormwater management with respect to MPC Articles V (Subdivision and Land Development) and VII (Planned Residential Development).



must be filed with the [governing body] If a decision appealed is from an authorized person or agency of the Municipality, a copy of the written appeal must be filed with such person or agency by such appellant within thirty (30) days of such decision.

2. The appellant shall pay to the Municipality at the time of filing the appeal, any and all fees and charges as set forth in a Resolution of the Municipality.

B. Procedure. Any Appeal filed pursuant to this section shall be governed by the Local Agency Law of the Commonwealth of Pennsylvania (2 Pa. C.S.A. §105, specifically 2 Pa. C.S.A. §551-§555).

C. Hearing. The [governing body] shall schedule a hearing within sixty (60) days of receipt of said Appeal. Written notice of the hearing shall be given to the party filing the Appeal and any authorized person or agency of the Municipality involved, not less than fifteen (15) days prior to said hearing.

D. Hearing Procedure.

1. All testimony may be stenographically recorded and a full and complete record be kept of the proceedings. In the event all testimony is not stenographically recorded and a full and complete record of the proceedings is not provided by the local agency, such testimony shall be stenographically recorded and a full and complete record of the proceedings and shall be kept at the request of any party agreeing to pay the costs thereof.
2. The [governing body] shall not be bound by technical rules of the evidence at the aforesaid hearing, and all relevant evidence of reasonably probative value may be received. Reasonable examination and cross-examination shall be permitted.

E. Adjudication.

The adjudication of the [governing body] shall be in writing, shall contain findings and the reasons for the adjudication, and shall be served upon all parties to the Appeal or their counsel personally, or by mail.

F. Appeal from Adverse Adjudication.

Pursuant to 2 Pa. C.S.A. Section 751 et seq. any person aggrieved by the adjudication of [governing body] who has a direct interest in such adjudication shall have the right to appeal therefrom to the Court vested with jurisdiction of such appeals by or pursuant to Title 42 (Relating to Judiciary and Judicial Procedure).

## REFERENCES

1. U.S. Department of Agriculture, National Resources Conservation Service (NRCS). *National Engineering Handbook*. Part 630: Hydrology, 1969-2001. Originally published as the *National Engineering Handbook*, Section 4: Hydrology. Available from the NRCS online at: <http://www.nrcs.usda.gov/>.
2. U.S. Department of Agriculture, Natural Resources Conservation Service. 1986. *Technical Release 55: Urban Hydrology for Small Watersheds*, 2nd Edition. Washington, D.C.
3. Pennsylvania Department of Environmental Protection. No. 363-0300-002 (December 2006), as amended and updated. *Pennsylvania Stormwater Best Management Practices Manual*. Harrisburg, PA.
4. Pennsylvania Department of Environmental Protection. No. 363-2134-008 (March 31, 2012), as amended and updated. *Erosion and Sediment Pollution Control Program Manual*. Harrisburg, PA.
5. U.S. Department of Commerce, National Oceanic and Atmospheric Administration, National Weather Service, Hydrometeorological Design Studies Center. 2004-2006. *Precipitation-Frequency Atlas of the United States, Atlas 14*, Volume 2, Version 3.0, Silver Spring, Maryland. Internet address: <http://hdsc.nws.noaa.gov/hdsc/pfds/>.
6. PennDOT **Publication 408 – Construction Specifications, Publication 584 - Drainage Manual** current editions.

**Appendix A** Stormwater Management Performance Districts (TBD)

**Appendix B** Example: Operation and Maintenance Agreement [requires solicitor review]

**Appendix C** Small Project Stormwater Management Site Plan

**Appendix D** Stormwater Management Plan Checklist

[**Appendix E** Fees, Financial Guarantees]



**Westmoreland County Model Stormwater Management Ordinance**

**APPENDIX A**

**STORMWATER MANAGEMENT PERFORMANCE DISTRICT MAPS**

**Refer to the Watershed Performance District (Release Rate) Maps at [www.westmorelandstormwater.org](http://www.westmorelandstormwater.org)**

**NOTE:** For areas not covered by current recommended Performance District (release rate) Maps, municipalities are authorized to establish performance standards / release rates as discussed in 308.D of the Stormwater Management Ordinance.

**NOTE:** Municipalities are authorized to establish release rates stricter than those established by the recommended Performance District Maps upon consultation with WCD and their municipal engineer.

DRAFT

**Westmoreland County Model Stormwater Management Ordinance  
APPENDIX B**

**[LANDOWNER LETTER OF ACKNOWLEDGMENT]**

**Project Name:** \_\_\_\_\_ **Date:** \_\_\_\_\_  
**Location:** \_\_\_\_\_

- New impervious areas can potentially increase stormwater runoff from this site and the use of proposed stormwater facilities and/or best management practices (BMPs) can manage those impacts by mimicking natural processes to provide groundwater recharge and stream base flow.
- Regulated development activities on this site shall not begin until [municipality] has issued an approval for a Small Project Stormwater Management Plan.
- If stormwater management facilities and/or BMPs included on the approved Small Project Stormwater Site Plan require revisions or changes, the applicant shall submit a revised plan to the [municipality] for approval. If a problem arises, the applicant may need to seek the assistance of a qualified professional.
- Installed stormwater facilities and/or BMPs shall not adversely affect any property, septic systems, or drinking water wells on this or any other property.
- The applicant acknowledges that the installed stormwater management facilities and/or BMPs will be a permanent fixture of the property, shall be inspected and maintained regularly to retain the original function, and cannot be altered or removed without the approval of the [municipality].

I (we) \_\_\_\_\_, hereby acknowledge the above statements and agree to assume full responsibility for the implementation, construction, operation, and maintenance of the proposed stormwater management facilities and/or BMPs. Furthermore, I (we) acknowledge that the steps, assumptions, and guidelines provided in the [municipality] Small Project Stormwater Management Plan and Worksheet will be adhered to.

Signature: \_\_\_\_\_ Date: \_\_\_\_\_

Signature: \_\_\_\_\_ Date: \_\_\_\_\_



**Westmoreland County Model Stormwater Management Ordinance**

**APPENDIX B**

**[OPERATION AND MAINTENANCE (O&M) AGREEMENT (solicitor review)  
STORMWATER MANAGEMENT BEST MANAGEMENT PRACTICES (SWM BMPs)]**

**THIS AGREEMENT**, made and entered into this day \_\_\_\_\_ of \_\_\_\_\_, 20\_\_\_\_, by and between \_\_\_\_\_ (hereinafter the “Landowner”), and \_\_\_\_\_, Westmoreland County, Pennsylvania (hereinafter “Municipality”);

**WITNESSETH**

**WHEREAS**, the Landowner is the owner of certain real property as recorded by deed in the land records of Westmoreland County, Pennsylvania, Deed Book \_\_\_\_\_ at page \_\_\_\_\_, (hereinafter “Property”).

**WHEREAS**, the Landowner is proceeding to build and develop the Property; and

**WHEREAS**, the SWM BMP Operation and Maintenance (O&M) Plan approved by the Municipality (hereinafter referred to as the “O&M Plan”) for the property identified herein, which is attached hereto as Appendix A and made part hereof, as approved by the Municipality, provides for management of stormwater within the confines of the Property through the use of BMPs; and

**WHEREAS**, the Municipality, and the Landowner, his successors and assigns, agree that the health, safety, and welfare of the residents of the Municipality and the protection and maintenance of water quality require that on-site SWM BMPs be constructed and maintained on the Property; and

**WHEREAS**, the Municipality requires, through the implementation of the SWM Site Plan, that SWM BMPs as required by said SWM Site Plan and the Municipal Stormwater Management Ordinance be constructed and adequately operated and maintained by the Landowner, successors, and assigns.

**NOW, THEREFORE**, in consideration of the foregoing promises, the mutual covenants contained herein, and the following terms and conditions, the parties hereto agree as follows:

1. The Landowner shall construct the BMPs in accordance with the plans and specifications identified in the SWM Site Plan.
2. The Landowner shall operate and maintain the BMPs as shown on the SWM Site Plan in good working order in accordance with the specific operation and maintenance requirements noted on the approved O&M Plan.
3. The Landowner hereby grants permission to the Municipality, its authorized agents and employees, to enter upon the property, at reasonable times and upon presentation of proper credentials, to inspect the BMPs whenever necessary. Whenever possible, the Municipality shall notify the Landowner prior to entering the property.
4. In the event the Landowner fails to operate and maintain the BMPs per paragraph 2, the Municipality or its representatives may enter upon the Property and take whatever action is deemed necessary to maintain said BMP(s). It is expressly understood and agreed that the Municipality is under no obligation to maintain or repair said facilities, and in no event shall this Agreement be construed to impose any such obligation on the Municipality. A timeline shall be set as mutually agreed upon .....

5. In the event the Municipality, pursuant to this Agreement, performs work of any nature, or expends any funds in performance of said work for labor, use of equipment, supplies, materials, and the like, the Landowner shall reimburse the Municipality for all expenses (direct and indirect) incurred within 10 days of receipt of invoice from the Municipality.

6. The intent and purpose of this Agreement is to ensure the proper maintenance of the on-site BMPs by the Landowner; provided, however, that this Agreement shall not be deemed to create any additional liability of any party for damage alleged to result from or be caused by stormwater runoff.

7. The Landowner, its executors, administrators, assigns, and other successors in interests, shall release the Municipality from all damages, accidents, casualties, occurrences, or claims which might arise or be asserted against said employees and representatives from the construction, presence, existence, or maintenance of the BMP(s) by the Landowner or Municipality.

8. The Municipality intends to inspect the BMPs at a minimum of once every three years to ensure their continued functioning.

This Agreement shall be recorded at the Office of the Recorder of Deeds of Westmoreland County, Pennsylvania, and shall constitute a covenant running with the Property and/or equitable servitude, and shall be binding on the Landowner, his administrators, executors, assigns, heirs, and any other successors in interests, in perpetuity.

ATTEST:

WITNESS the following signatures and seals:

(SEAL)

For the Municipality:

\_\_\_\_\_

For the Landowner:

\_\_\_\_\_

ATTEST:

\_\_\_\_\_(City, Borough, Township)

County of Westmoreland, Pennsylvania

I, \_\_\_\_\_, a Notary Public in and for the county and state aforesaid, whose commission expires on the day \_\_\_\_ of \_\_\_\_\_, 20\_\_\_\_, do hereby certify that whose name(s) is/are signed to the foregoing Agreement bearing date of the \_\_\_\_ day of \_\_\_\_\_, 20\_\_\_\_, has acknowledged the same before me in my said county and state.

**GIVEN UNDER MY HAND THIS** \_\_\_\_ day of \_\_\_\_\_, 20 \_\_\_\_.

\_\_\_\_\_  
NOTARY PUBLIC

\_\_\_\_\_  
(SEAL)



**Westmoreland County Model Stormwater Management Ordinance**  
**APPENDIX C**  
**[Municipality]**  
**SMALL PROJECT STORMWATER MANAGEMENT PLAN**

This small project stormwater management plan has been developed to assist those proposing residential projects to meet the requirements of the *Westmoreland County Model Stormwater Management Ordinance* (SWO) without having to draft a formal stormwater management plan. This small project stormwater management plan is only permitted for projects with new impervious area between [1,000] [3,000] and [10,000] square feet, or total earth disturbance between [3,000] [5,000] and [20,000] square feet, (Section 302 Regulated Development Activity Table of the SWO) and by using the recommendations in this Appendix for Volume Control. Additional information can be found in Chapter 6 of the PA SW BMP Manual 2006 or most recent version.

**A. What is an applicant required to submit?**

All requirements of Section 306 of the [Municipality] Stormwater Management Ordinance, including:

- A narrative including a brief description of the proposed stormwater facilities and BMPs, types of materials to be used, total square footage of proposed impervious areas, volume calculations;
- A sketch plan showing location of existing and proposed structures, driveways, or other paved areas with approximate surface area in square feet; location of any existing or proposed utilities, especially onsite septic system and/or potable water wells showing proximity to infiltration facilities, location and dimensions of all proposed stormwater facilities and BMPs;
- Small Project Stormwater Management Worksheet;
- Signed [acknowledgment] [agreement] page for installation, operation and maintenance of stormwater facilities and BMPs (Refer to Appendix B); and
- Conservation District erosion and sediment control “Adequacy” letter as required by Municipal, County or State regulations;

**B. Determination of Required Control Volume and Sizing Stormwater Facilities and BMPs**

By following the simple steps outlined below in the provided example and Small Project Stormwater Management Worksheet, an applicant can determine the runoff volume that is required to be controlled and how to choose the appropriate stormwater facility or BMP to permanently remove the runoff volume from the site. Impervious area calculations must include all areas on the lot proposed to be covered by roof area or pavement which would prevent rain from naturally percolating into the ground, including proposed impervious surfaces such as sidewalks, driveways, parking areas, patios or swimming pools. **NOTE: Sidewalks, driveways or patios that are designed and constructed to allow for infiltration (permeable paving systems) are not included in this calculation.**

**Small Project Sketch Plan: Example**

**Project Name:** \_\_\_\_\_ **Date:** \_\_\_\_\_

**Location:** \_\_\_\_\_

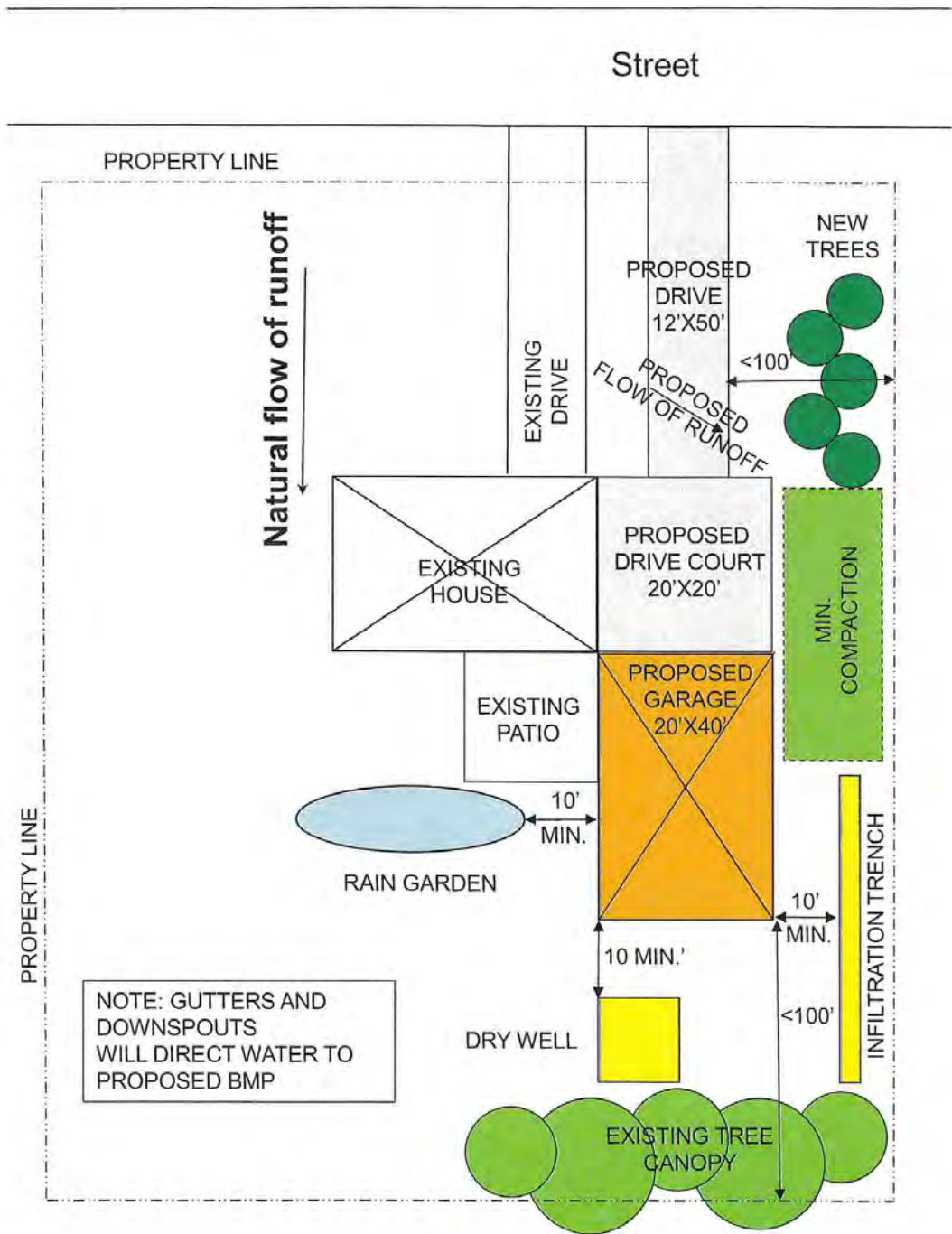



**Step 1: Determine Total Impervious Surfaces and Required Control Volume:**

**TABLE 1: Example**

New Impervious Surface	Dimensions (width x length) (FT)	Area in SF	[1"] [2"] storm Multiplier (0.083) (0.167)	Required Control Volume [1"] [2"] in CF
<i>Garage Roof</i>	<i>20'x40'</i>	<i>800</i> SF	<i>0.167</i>	<i>133</i> CF
<i>Driveway Court</i>	<i>20'x20'</i>	<i>400</i> SF	<i>0.167</i>	<i>67</i> CF
<i>Driveway</i>	<i>12'x50'</i>	<i>600</i> SF	<i>0.167</i>	<i>100</i> CF
		SF		CF
		SF		CF
		SF		CF

**Total Required Control Volume (enter in Table 2):** 300 **CF**

In Table 1, as in the example above and as shown on the Figure 1 example sketch plan, list each of the new improvements that create impervious area on the property along with their dimensions and total area in square feet in the first three columns. Then, depending on the design storm required by the municipality, multiply the area in square feet by the design storm multiplier to determine required control volume and list in the last column. Add each of the required control volumes together to equal the Total Required Control Volume and enter in Table 2.

**Step 2: Sizing the Selected Volume Control BMP(s)**

Several Best Management Practices (BMPs) are suitable for small stormwater management projects. However, their application depends on the volume required to be controlled, how much land is available, and the site constraints. Proposed residential development activities can apply both nonstructural and structural BMPs to control the volume of runoff from the site. A number of these different volume control BMPs are described below. Note that Figure 1 is an example of how these BMPs can be utilized on a property to control the total required control volume.

Credit can be taken for non-structural best management practices (BMPs) on a site to reduce the total volume required to be controlled. Credits must follow the requirements listed in this Appendix. Fill out Table 2 with proposed non-structural BMP credits and structural BMP control volumes entered in Tables 6 and 10 to meet the total required control volume.

**TABLE 2: Example**

<b>Required Control Volume (Table 1)</b>	<b>300 CF</b>
Non-structural BMP Credit (Table 6)	137 CF
<b>Adjusted Required Control Volume (after credits) (Table 1 - Table 6)</b>	<b>163 CF</b>
Structural BMP Control Volume (Table 10)	202 CF
<b>TOTAL Volume Controlled (Table 6 +Table 10)</b>	<b>338 CF</b>

NOTE: Total Volume Controlled shall be **greater than or equal to** Required Control Volume.

### Step 3: Choosing and Measuring Non-Structural BMPs

#### 1. Tree Planting and Preservation

Trees and forests reduce stormwater by capturing, storing and evapotranspiring rainfall through their roots and leaves. Tree roots and leaf litter also create soil conditions that promote infiltration of rainwater into the soil and that breakdown excessive nutrients and pollutants. For more information refer to the PA DEP BMP Manual 5.6.3.

Considerations for credit:

- New tree plantings must be at least 6 feet in height and have at least a 2 inch caliper trunk, and the quantity entered in Table 3
- New tree plantings must be native to Pennsylvania. Refer to <http://www.dcnr.pa.gov/Conservation/WildPlants/Pages/default.aspx>
- Existing trees must have at least a 4" caliper trunk, and must be located within 100 feet of impervious surfaces
- Measure existing tree canopy by determining the square foot area covered within the drip line of the tree(s), and enter the area in Table 4
- Site runoff should be directed via sheet flow to the area(s) of trees being used for volume control

**TABLE 3: New Tree(s)**

New Trees	Volume Control Multiplier	Tree Quantity	Volume Controlled (CF)
Deciduous	6 CF	2	12 CF
Evergreen	10 CF	3	30 CF

Total Volume Control Credit (new trees) enter in Table 6: 42 CF

**TABLE 4: Existing Tree Canopy**

Existing Tree Canopy (SF)	Distance of Impervious to Canopy (FT)	Volume Control Multiplier	Volume Controlled (CF)
SF	0 FT to 20 FT	0.0833	CF
2000	20 FT to 100 FT	0.0416	83 CF

Total Volume Control Credit (ex. trees) enter in Table 6: 83 CF



Remove all synthetic material from the root ball before planting

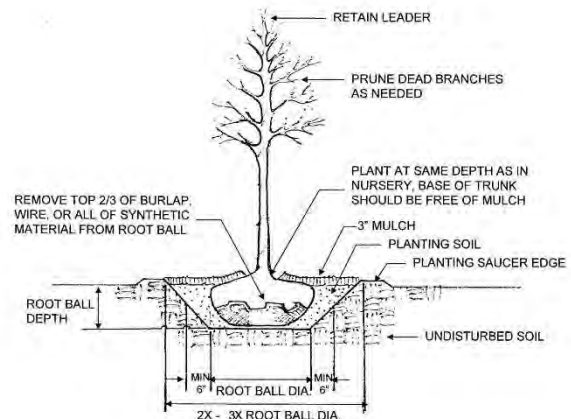

**TREE PLANTING**

WCD 2009 N.T.S.



## 2. Minimize Soil Compaction and Revegetate (lawn or meadow seeding)

When soil is overly compacted during construction it can cause a drastic reduction in the permeability of the soil and rarely is the soil profile completely restored. Runoff from overly compacted vegetated areas can resemble increased runoff from impervious areas. Minimizing soil compaction during the construction process, or restoring and amending compacted soils and revegetating them after construction can greatly increase natural infiltration on a site. For more information refer to the PA DEP BMP Manual 5.6.2 and 5.6.3.

Considerations for credit:

- Area(s) shall not be stripped of topsoil and areas shall be protected from construction vehicles and lay down space with construction fencing or mats. Enter square foot area in Table 5.
- Soil ripping and soil amendments can be used to restore the soils
- Vegetation should be used, especially native plants and meadow mixes as an alternative to lawn

**TABLE 5: Minimize Soil Compaction Example**

Type of stabilization	Area of minimal compaction (SF)	Volume Control Multiplier	Volume Controlled (CF)
Meadow	SF	0.0275	CF
Lawn	600 SF	0.0208	12 CF

Total Volume Control Credit (min. compaction) enter in Table 6: 12 CF



Plywood sheets protect lawn from compaction



Fencing protects areas from compaction

### Step 4: Determining Non-Structural BMP Credit:

**TABLE 6: Non-Structural BMP Credit Summary: Example**

Non- structural BMP	Storage Volume Credit (CF)
New Tree	42 CF
Existing Tree Canopy	83 CF
Minimized Soil Compaction	12 CF
<b>TOTAL (enter in Table 2)</b>	<b>137 CF</b>

## Step 5: Choosing and Sizing Structural BMPs

### 1. Infiltration Trench

An infiltration trench is a linear stormwater management BMP consisting of a continuously perforated pipe at a minimum slope in a stone-filled trench. During small storm events, infiltration trenches can significantly reduce volume and serve in the removal of fine sediments and pollutants. Runoff is stored in the pipe and between the stones and infiltrates through the bottom of the facility and into the surrounding soil matrix. Runoff should be pretreated using vegetative buffer strips or swales to limit the amount of coarse sediment entering the trench which can clog and render the trench ineffective. In all cases, an infiltration trench should be designed with a positive overflow to a stable outlet point. For more information refer to the PA DEP BMP Manual 6.4.4.

#### Design Considerations:

- Continuously perforated pipe (min 4" diameter) set at a minimum slope (1%) in a stone filled, nearly level-bottomed trench on un-compacted soils.
- The trench width and depth can vary, but it is recommended that infiltration trenches be no wider than four (4) feet, and a minimum of thirty (30) inches and maximum six (6) feet in depth.
- Stone fill should be clean, angular stone, separated from soil layers by four (4) inches of straw (top and bottom) or a nonwoven geotextile (top, sides, and bottom).
- A minimum of 6" of topsoil can be placed over trench and vegetated.
- Cleanouts or inlets should be installed at both ends and at intersections of the infiltration trench and at appropriate intervals to allow access to the perforated pipe.
- The discharge or outlet from the infiltration trench should be safely conveyed to a stable vegetated area, natural watercourse, the curb or gutter line of roadway or existing storm collection/conveyance/control system as applicable.
- Volume of facility = Depth x Width x Length x Void Space of the gravel bed (assume 40%).

#### Maintenance:

- Cleanouts, catch basins and inlets should be inspected at least two times a year and cleaned out as necessary to maintain function of the system.
- The vegetation along the surface of the infiltration trench should be maintained in good condition and any bare spots should be re-vegetated as soon as possible.
- Vehicles should not be parked or driven on the trench and care should be taken to avoid soil compaction by lawn mowers.

**TABLE 7 - Determining size of infiltration trench for volume control: Example**

Required Control Volume (CF) From Table 2	Storage Volume Divider	Trench Volume (CF)	Trench Depth (FT)	Trench Width (FT)	Trench Length (FT)	Volume Controlled
163	0.4	413 CF	3FT	3FT	46FT	165 CF

Total Volume Control Credit (Inf. trench) **enter in Table 10:** 165 CF



Infiltration Trench Construction:

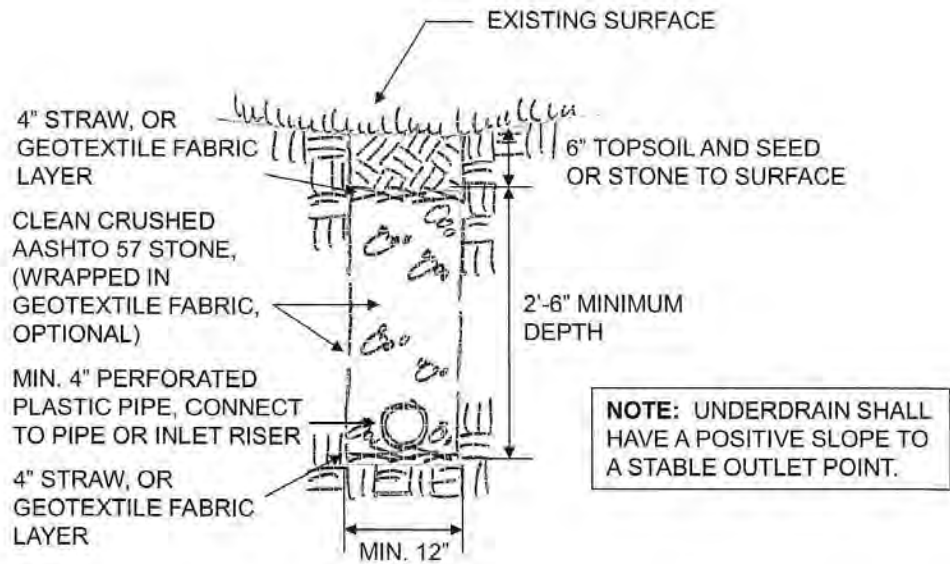

Perforated pipe covered with stone and wrapped in fabric



Perforated pipe covered in stone with straw separation layers

## 2. Rain Garden

A rain garden is a landscaped shallow depression that uses mulch, soil mix, and deep rooted plants to capture, adsorb and infiltrate stormwater runoff from roofs, and pavement. For more information refer to the PA DEP BMP Manual 6.4.5.

Design considerations:

- A rain garden should be located on nearly level to gently sloping ground and no closer than 10 feet to a building foundation and 25 feet from septic field or wellhead.
- A rain garden can vary in length, width and depth, but should have a ponding depth of 6 to 12 inches, and a total surface depth of no greater than 18 inches.
- Side slopes within the garden should not exceed 3:1 horizontal to vertical.
- The rain garden should be constructed in layers with a (min 4”) perforated underdrain in a clean angular stone envelope, separated from soil layers by four (4) inches of straw (top and bottom) or a nonwoven geotextile (top, sides, and bottom), covered with 12 inches to 36 inches of 50-30-20 topsoil-sand-compost mix or as approved by the municipality, and 3 inches of shredded bark mulch or vegetated cover. Soil depth should be determined by plant choices and control volume requirements.
- Vegetation should be deep rooted and tolerant of wet and dry conditions, salts and environmental stress.
- An emergency overflow should be set in the rain garden such as a vertical pipe or inlet box, with basket type grate set even with the ponding depth, below the surrounding ground elevation and connected to the perforated underdrain and an outlet pipe.
- The outlet from the rain garden should be safely conveyed to a stable vegetated area, natural watercourse, the curb or gutter line of roadway or existing storm collection/conveyance/control system as applicable.

Maintenance:

- Cleanouts, catch basins and inlets should be inspected at least two times a year and cleaned out as necessary to maintain function of the system. Detritus should be removed from the rain garden as necessary to prevent clogging of the overflow outlet.
- The vegetation should be maintained in good condition and replaced as necessary. Rain garden plants may need to be watered during dry spells.
- Rain garden should be weeded and shredded bark mulch should be amended as necessary to prevent volunteer weeds.

**TABLE 8 – Determining Size of Rain Garden for volume control: Example**

(surface volume, soil storage volume should **each** be greater than or equal to required control volume)

Required Control Volume (CF) from Table 2	Ponding Depth (0.5 FT to 1.0 FT) Divider	Rain Garden Surface Area (SF)	Rain Garden Width (FT)	Rain Garden Length (FT)	Soil Mix Depth (1 FT to 3 FT) Multiplier	Soil Storage Volume Multiplier	Soil Storage Volume (<= RCV)	Volume Controlled (soil)
165 CF	0.5	330 SF	12 FT	28FT	2 FT	0.3	202 CF	202 CF

Total Volume Control Credit (rain garden) **enter in Table 10:** 202 CF



## Rain Garden Construction:

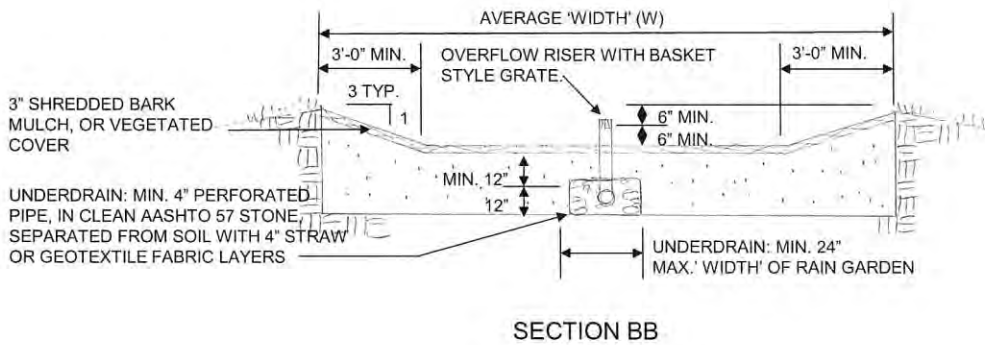
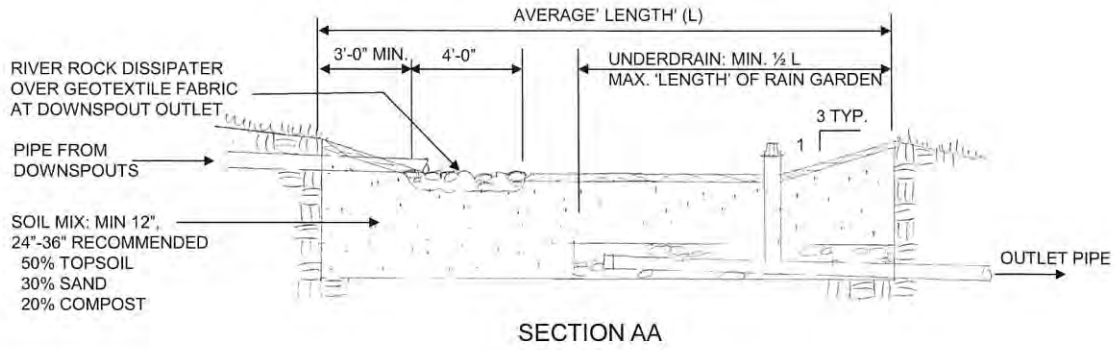

Mark rain garden location to avoid utilities



Excavate rain garden at least 10' from foundation



Separate underdrain layer from soil with fabric or straw



Use decorative but tolerant plants for seasonal interest

### 3. Dry Well / Seepage Pit

A dry well or seepage pit is a subsurface storage facility that temporarily stores stormwater runoff from roofs and infiltrates it into the surrounding soils. Roof downspouts connect directly to a dry well or seepage pit that is an excavated pit filled with clean angular stone with an overflow pipe to ensure the system will not be overwhelmed. Prefabricated chamber systems or perforated pipe sections are commercially available for use as dry wells and should be designed, constructed and maintained according to the manufacturer’s recommendations. For more information on dry wells and seepage pits refer to the PA DEP BMP Manual 6.4.6.

Design considerations:

- A dry well / seepage pit should be located on nearly level to gently sloping ground and no closer than 10 feet to a building foundation and 25 feet from septic field or wellhead.
- A dry well / seepage pit can vary in length, width and depth, but should be a minimum depth of 3 feet.
- A downspout should direct water to the surface, a system of perforated pipes should distribute the water throughout the system with an inspection/cleanout pipe to the surface, and an over flow pipe should outlet excess water during intense storms.
- The storage system can be clean angular stone, separated from soil layers by four (4) inches of straw (top and bottom) or a nonwoven geotextile (top, sides, and bottom).
- The outlet from the dry well / seepage pit should be safely conveyed to a stable vegetated area, natural watercourse, the curb or gutter line of roadway or existing storm collection/conveyance/control system as applicable.

Maintenance:

- Drywells and seepage pits should be inspected at least 4 times a year, and after each storm event exceeding 1 inch.
- Remove sediment, debris, detritus and any other waste material from the system as necessary.
- Regularly clean out gutters and downspouts to ensure proper connections and to maintain effectiveness of the system.
- Replace any filter screen or clean out any sump box that may intercept roof runoff as necessary.

**Table 9: Determining Size of Dry Well (stone filled) for volume control: Example**

Required Control Volume (CF) from Table 2	Storage Volume Divider	Dry Well Volume (CF)	Dry Well Depth (FT)	Dry Well Width (FT)	Dry Well Length (FT)	Volume Controlled (CF)
165	0.4	413 CF	5 FT	9 FT	9.2 FT	165 CF

Total Volume Control Credit (dry well) **enter in Table 10:** 165 CF

**NOTE:** Applicants are required to utilize the manufacturer’s recommendations for sizing proprietary stormwater infiltration systems, and to submit supporting documentation for meeting the required control volume and maintenance requirements.



Dry Well (stone filled) Construction:

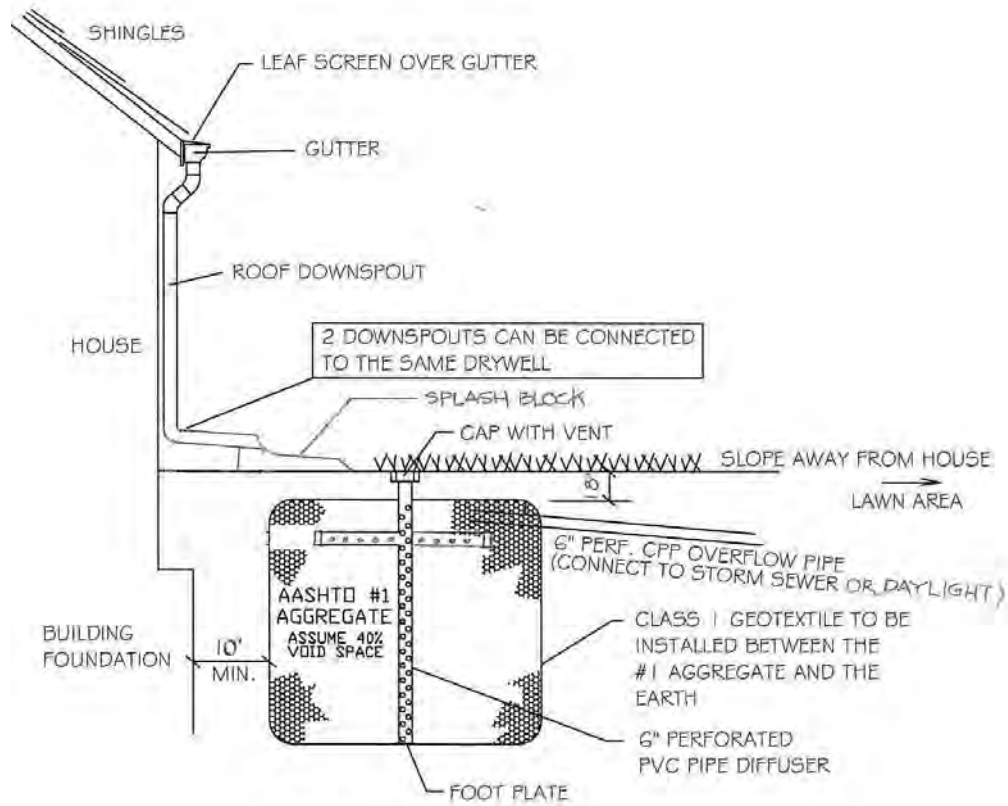

Excavate a drywell at least 10' from foundation



Separate stone fill from soil with straw layers or fabric

#### 4. Alternative BMP Capture and Re-Use (rain barrel / cistern)

Rain barrels and cisterns are above or below ground containers used for temporary storage of rainwater, to be used for landscape irrigation and other similar uses after the rain has ended. A rain barrel or cistern **cannot be used** as a volume control because infiltration is not guaranteed after a storm event, but they are viable alternative method to capture and reuse stormwater.

Considerations:

- Rain barrels and cisterns should be directly connected to a downspout with a mosquito screen
- There should be a means to release the water after a storm event to provide storm volume for the next event
- An overflow, near the top of the container should direct water to a vegetated area away from any structures
- Barrels can be connected in series to provide more volume collection

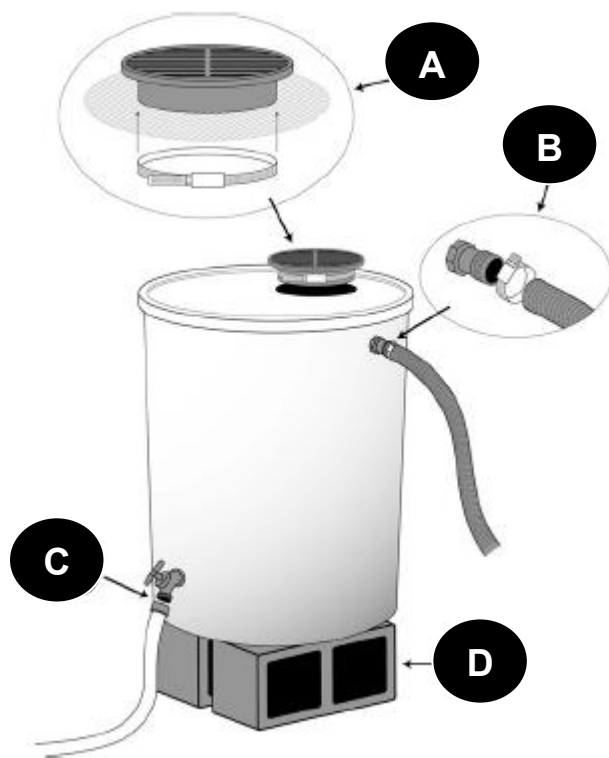

#### ANATOMY OF A RAIN BARREL

A – hole in top for downspout connection, with screen for mosquitoes

B – hole on side near top for overflow hose

C – hole on side near



## Step 6: Determining BMP Volume Control

**TABLE 10: Structural BMP Volume Control Summary:**

<b>Structural BMP</b>	<b>Storage Volume (CF)</b>
Infiltration Trench	CF
Rain Garden	202
Dry Well	CF
<b>TOTAL (enter in Table 2)</b>	<b>202</b>

*Use Small Project Stormwater Management Worksheet*

## Step 7: Post-Installation Operation and Maintenance Requirements

It is the property owner's responsibility to properly maintain any stormwater facilities and BMPs in accordance with the minimum maintenance requirements listed in this Appendix. The property owner shall submit a signed [acknowledgment] [agreement], [and declaration of easement] to the [Municipality] for installation, and maintenance of any proposed stormwater management facilities and BMPs. It is also the property owner's responsibility to inform any future owners of the function, operation and maintenance needed for any BMPs on the property prior to the purchase of the property.

*Refer to Sample(s) Appendix B*

## SMALL PROJECT STORMWATER MANAGEMENT WORKSHEET

For [Municipality]

Project Name: \_\_\_\_\_ Date: \_\_\_\_\_

Location: \_\_\_\_\_

**TABLE 1: Determination of Control Volume Requirements:**

New Impervious Surface	Area in SF	[1"] [2"] storm Multiplier (0.083) (0.167)	Required Control Volume [1"] [2"] in CF
	SF		CF
	SF		CF
	SF		CF
	SF		CF
	SF		CF
	SF		CF

**Total Required Control Volume (enter in Table 2):** \_\_\_\_\_ **CF**

**TABLE 2: Determination of Volume Controlled:**

<b>Required Control Volume (Table 1)</b>	<b>CF</b>
Non-structural BMP Credit (Table 6)	-
<b>Adjusted Required Control Volume (after credits) (Table 1 – Table 6)</b>	<b>CF</b>
Structural BMP Control Volume (Table 10)	CF
<b>TOTAL Volume Controlled (Table 6 + Table 10)</b>	<b>CF</b>

NOTE: Total Volume Controlled shall be **greater than or equal to** Required Control Volume.

### Determining Non-Structural BMP Credit:

**TABLE 3: New Tree(s)**

New Trees	Volume Control Multiplier	Tree Quantity	Volume Controlled (CF)
Deciduous	6 CF		CF
Evergreen	10 CF		CF

Total Volume Control Credit (new trees) **enter in Table 6:** \_\_\_\_\_ **CF**

**TABLE 4: Existing Tree Canopy**

Existing Tree Canopy (SF)	Distance of Impervious to Canopy (FT)	Volume Control Multiplier	Volume Controlled (CF)
SF	0 FT to 20 FT	0.0833	CF
SF	20 FT to 100 FT	0.0416	CF

Total Volume Control Credit (ex. trees) **enter in Table 6:** \_\_\_\_\_ **CF**



**TABLE 5: Minimize Soil Compaction**

Type of stabilization	Area of minimal compaction (SF)	Volume Control Multiplier	Volume Controlled (CF)
Meadow	SF	0.0275	CF
Lawn	SF	0.0208	CF

Total Volume Control Credit (min. compaction) **enter in Table 6:** \_\_\_\_\_ CF

**TABLE 6: Non-Structural BMP Credit Summary:**

Non- structural BMP	Storage Volume Credit (CF)
New Tree	CF
Existing Tree Canopy	CF
Minimized Soil Compaction	CF
<b>TOTAL (enter in Table 2)</b>	<b>CF</b>

**Sizing of Structural BMPs:****TABLE 7: Infiltration Trench (stone filled)**

Required Control Volume (CF)	Storage Volume Divider	Trench Volume (CF)	Trench Depth (FT)	Trench Width (FT)	Trench Length (FT)	Volume Controlled
CF	0.4	CF	FT	FT	FT	CF

Total Volume Control Credit (Inf. trench) **enter in Table 10:** \_\_\_\_\_ CF

**TABLE 8: Rain Garden (surface & soil storage volume should be greater than or equal to required control vol.)**

Required Control Volume (CF)	Ponding Depth (0.5 FT to 1.0 FT) Divider	Rain Garden Surface Area (SF)	Rain Garden Width (FT)	Rain Garden Length (FT)	Soil Mix Depth (1 FT to 3 FT) Multiplier	Soil Storage Volume Multiplier	Soil Storage Volume (<= RCV)	Volume Controlled (soil)
CF	FT	SF	FT	FT	FT	0.3	CF	CF

Total Volume Control Credit (rain garden) **enter in Table 10:** \_\_\_\_\_ CF

**TABLE 9: Dry Well (stone filled)**

Required Control Volume (CF)	Storage Volume Divider	Dry Well Volume (CF)	Dry Well Depth (FT)	Dry Well Width (FT)	Dry Well Length (FT)	Volume Controlled (CF)
CF	0.4	CF	FT	FT	FT	CF

Total Volume Control Credit (dry well) **enter in Table 10:** \_\_\_\_\_ CF

**TABLE 10: Structural BMP Volume Control Summary:**

Structural BMP	Volume Controlled (CF)
Infiltration Trench	CF
Rain Garden	CF
Dry Well	CF
<b>TOTAL (enter in Table 2)</b>	<b>CF</b>

# Westmoreland County Model Stormwater Management Ordinance

## APPENDIX D

[Municipality]

### Stormwater Management Plan Checklist

See [Municipal] Stormwater Ordinance for complete requirements

Project Name: \_\_\_\_\_ Date: \_\_\_\_\_

Location: \_\_\_\_\_ Performance District: \_\_\_\_\_

Type of Plan: \_\_\_ Residential, \_\_\_ Commercial, \_\_\_ Institutional, \_\_\_ Industrial, \_\_\_ Recreational, \_\_\_ Other

Owner: \_\_\_\_\_ Contact Information: \_\_\_\_\_

Plan Preparer: \_\_\_\_\_ Contact Information: \_\_\_\_\_

#### **Submission Requirements**

- Checklist
- Application
- Fees and
- Location map (USGS)
- [x] sets completed plans, narrative
- E&S plan, as submitted for approval
- Operation and maintenance agreement
- Municipal notification(s)
- Financial guarantees, maintenance fund

#### **General Requirements**

Narrative:

- Project description, including Watershed Performance District, existing and proposed features and improvements, soils and limitations, landform, land cover, drainage areas, utilities, proposed SWM facilities and BMPs, easements and other information required by the [Municipality] stormwater ordinance
- Stormwater calculations
- Project schedule
- Construction sequence, including phases if applicable
- Justification for SWM facilities and/or BMPs
- Operation and Maintenance requirements and responsible party(s)

Plan:

- Location map (USGS)
- Watershed Performance District
- Existing natural features
- Soils; and limitations
- Landform; existing and proposed contours at 2' intervals, or 5' intervals for slopes >15%
- Land cover; existing and proposed improvements
- Drainage areas; existing and proposed
- Utilities; existing and proposed
- SWM facilities and BMPs; existing and proposed
- Easements, including offsite easements for drainage
- Stormwater construction details and sections (as applicable)
- Stormwater construction notes and sequence
- Operation and Maintenance requirements and responsible party(s)



**Westmoreland County Model Stormwater Management Ordinance**

**[APPENDIX E]**

**[FEES, FINANCIAL GUARANTEES]**

**[to be completed by municipality]**

DRAFT

## APPENDIX C

### Decision Making Flowchart Tool

The entire flowchart tool may be found at

<https://www.westmorelandstormwater.org/integrated-water-resource-plan-iwrp/flowchart-tool/>



## **DECISION MAKING FLOWCHART TOOL**

The Integrated Water Resources Plan (IWRP) Flowchart Tool has been designed with the assumption that ALL land use decision makers will be the primary users. **The Flowchart Tool can be found at <http://www.paiwrp.com/>**

During the development of the flowchart, it became apparent that the Tool could be useful for all County stakeholders, including planners, assessors, utilities, educators, and local, state, regional, national regulators, property owners, developers, designers, and even and tailored and adopted by other counties.

The IWRP Flowchart is the instrument by which the user will be led through a logical process of questions and recommendations which will ensure the user considers not only what is related to water resource management in the county, but also how the user's project(s) and/or actions will affect these resources, what regulations are to be met and what tools are available for use.

### **Integrated Water Resources Plan (IWRP) Flowchart Tool**

The Integrated Water Resources Plan (IWRP) Flowchart includes decisions, actions and recommendations which give more detail and definition to each process step of the flowchart. When thinking of how everything related to water interacts and ties together, the vision becomes very complex. The flowchart, and accompanying recommendations, is the County's attempt to tie everything related to water resources together in an understandable manner, and incorporating the processes, studies, reports, agencies, regulations and policies which already exist.

### **Flowchart**

The flowchart itself is the instrument by which the user will be led through a logical process of questions and suggestions which will ensure the user considers not only what is related to water resource management in the County, but also how the user's project(s) and/or actions will affect these resources. In essence, the flowchart will tie everything related to water resources together in a process that will hopefully be beneficial for County stakeholders, as well as for County water resources.

In an effort to be user friendly, the flowchart begins with one leg that takes users through considerations that all land use decisions makers should consider, then it is divided into four (4) segments or "legs." This includes the Infrastructure and Utility Leg, the Agriculture Leg, the Land Development Leg, and the Resource Extraction Leg. A graphic representation of the flowchart is provided in a series of pages following this summary.

The goal of the flowchart is to pull together what already exists, make stakeholders aware of what exists, explain enough about what exists to allow the user to determine if it is pertinent to a particular project, and provide contact information should more detailed information be desired. An inherent value of the flowchart is that it is applicable to all municipalities in the County and could easily be adapted for use by other counties in Pennsylvania.

## Flowchart Instructions

The instructions for using the flowchart, as set forth below, define and explain the symbols used in the flowchart. They also briefly describe the process flow path.

### Arrow Symbol

The arrow shows the direction of flow to be taken by the process of working through the flowchart

### Decision Diamond Symbol

The diamond is used where a decision is needed in order to determine which flowchart path will be followed

### Action Rectangle

The rectangle contains action steps or tasks to be completed in the flowchart process.

### Connection Symbols (to & from)

The paired connection symbols direct users to another section (leg) of the flowchart by looking for the matching symbol in order to avoid redundant/excessive lines in the flowchart.

**Process (symbol) label** - Each component of the flowchart has a unique identifying label which identifies the flowchart leg. The flowchart legs/sub-legs are identified as follows:

PROJQ – Preliminary Project Questions that all land-use decisions makers should consider

IU – Infrastructure and Utility: Any project dealing with support facilities such as transportation, water, sewer, communication, oil and gas and any other utility conveyance is considered Infrastructure and utility and should follow the Infrastructure and Utility leg.

A – Agriculture: Any project dealing with agriculture, agricultural structures and facilities and/or agricultural activity associated with streams and waterways such as streambank fencing, stream crossings, riparian buffers, ponds etc. is considered to be agriculture, and should follow the Agriculture leg.

LD – Land Development : Any project dealing with land development under the jurisdiction of municipal land regulations such as buildings, structures, paving, earth disturbance, subdivision of land, etc. is considered land development and should follow the Land Development leg.

RE – Resource Extraction : Any project dealing with the removal or development of natural resources such as timber, rock, soil, coal, oil and gas, etc is considered resource extraction and should follow the Resource Extraction leg.

In addition, the flowchart process steps are identified by an unique individual number which follows the flowchart leg letter. For example, the first process step of the Agriculture Leg is A1.

## Flowchart Recommendations

The flowchart recommendations, which are inserted after the flowchart, provide a brief description, definition, and/or explanation for each uniquely identified flowchart step. The recommendations will be most beneficial to stakeholders who are not familiar with water resources programs, policies, regulations, planning, design and development. Many users will find the flowchart to be most helpful when used in conjunction with the recommendations. **The Flowchart Tool can be found at <http://www.paiwrrp.com/>.** A graphic representation of the Flowchart Tool is on the following pages.



### Westmoreland County IWRP - Preliminary Project Questions

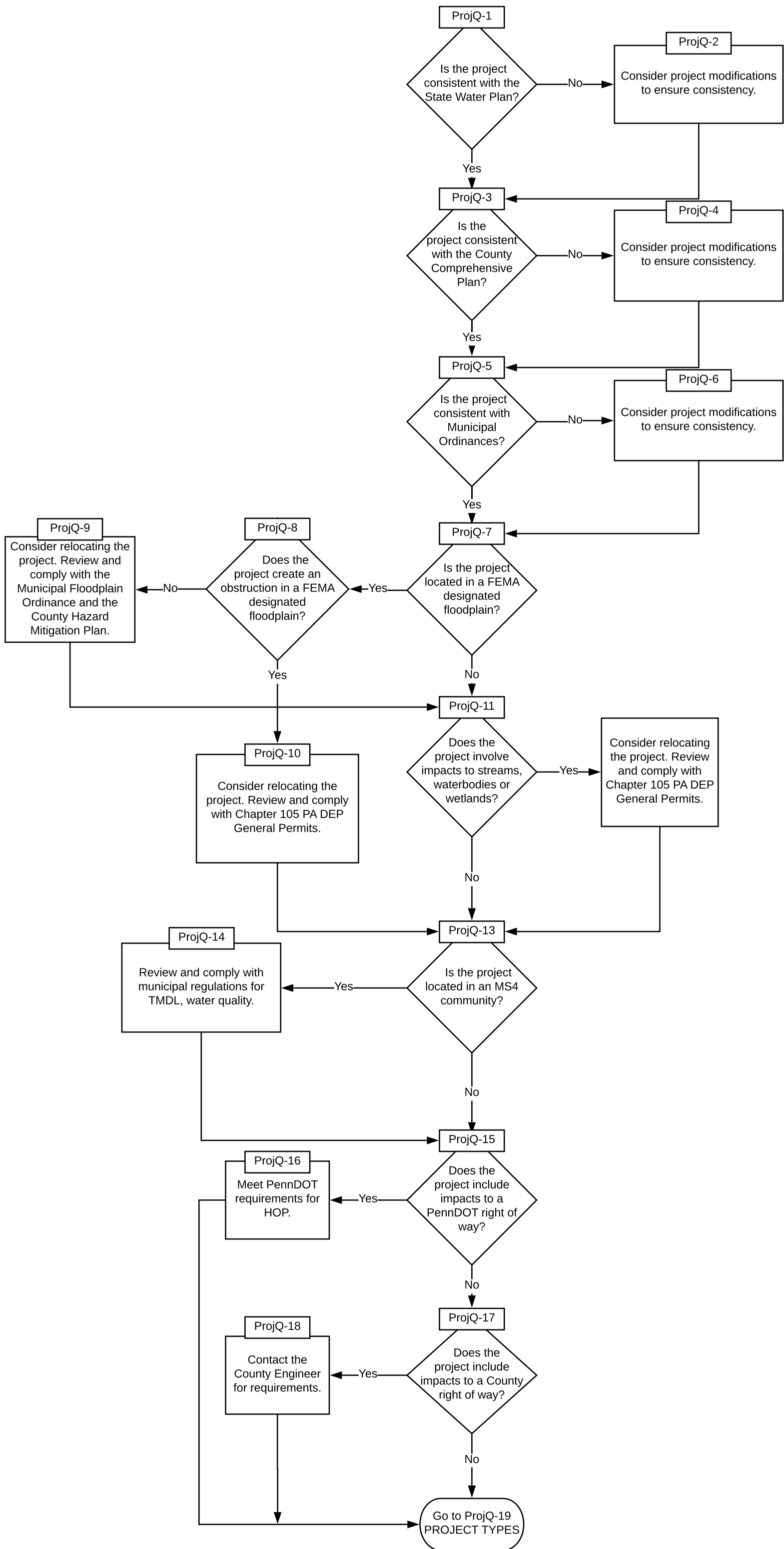

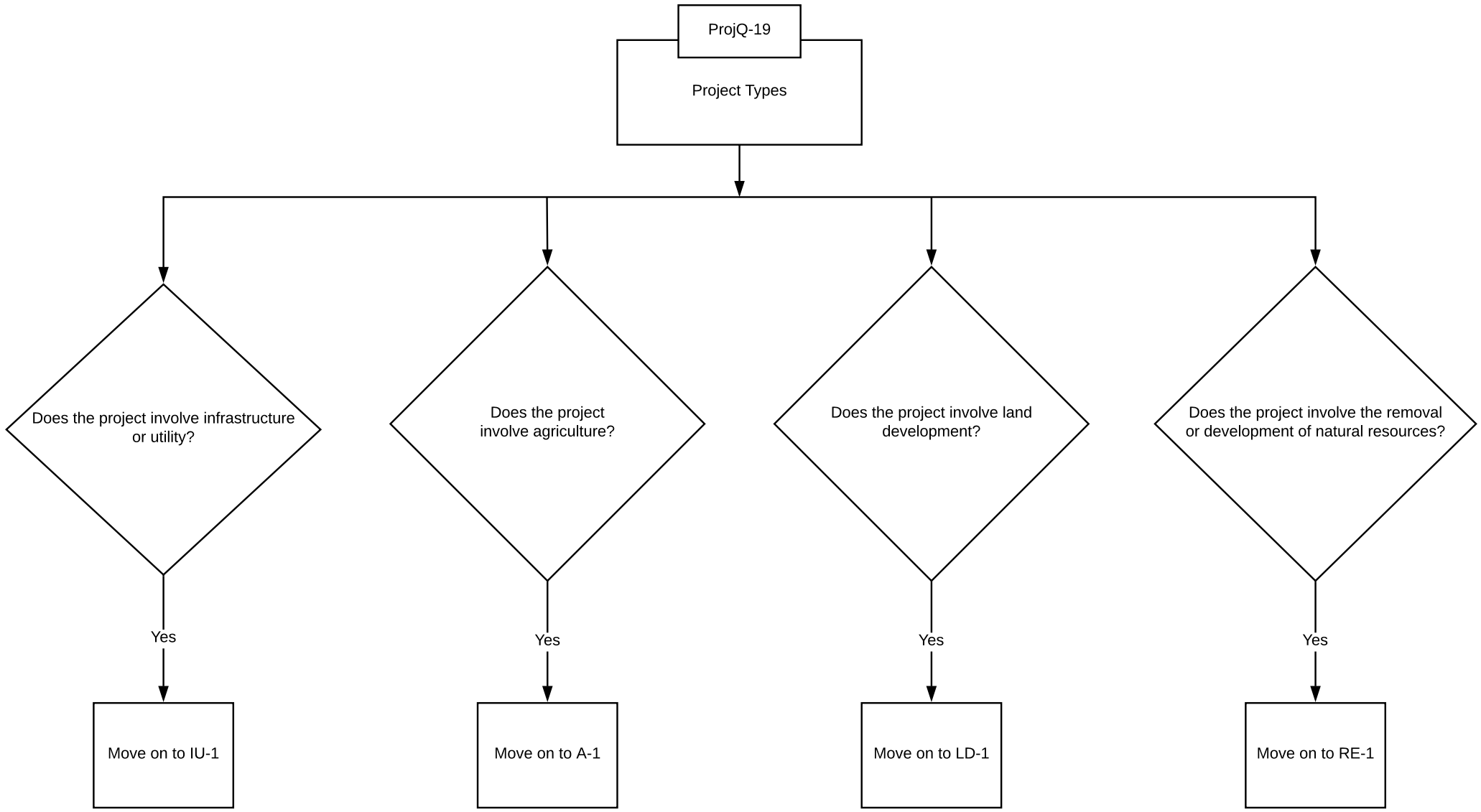



# Infrastructure and Utility (IU)

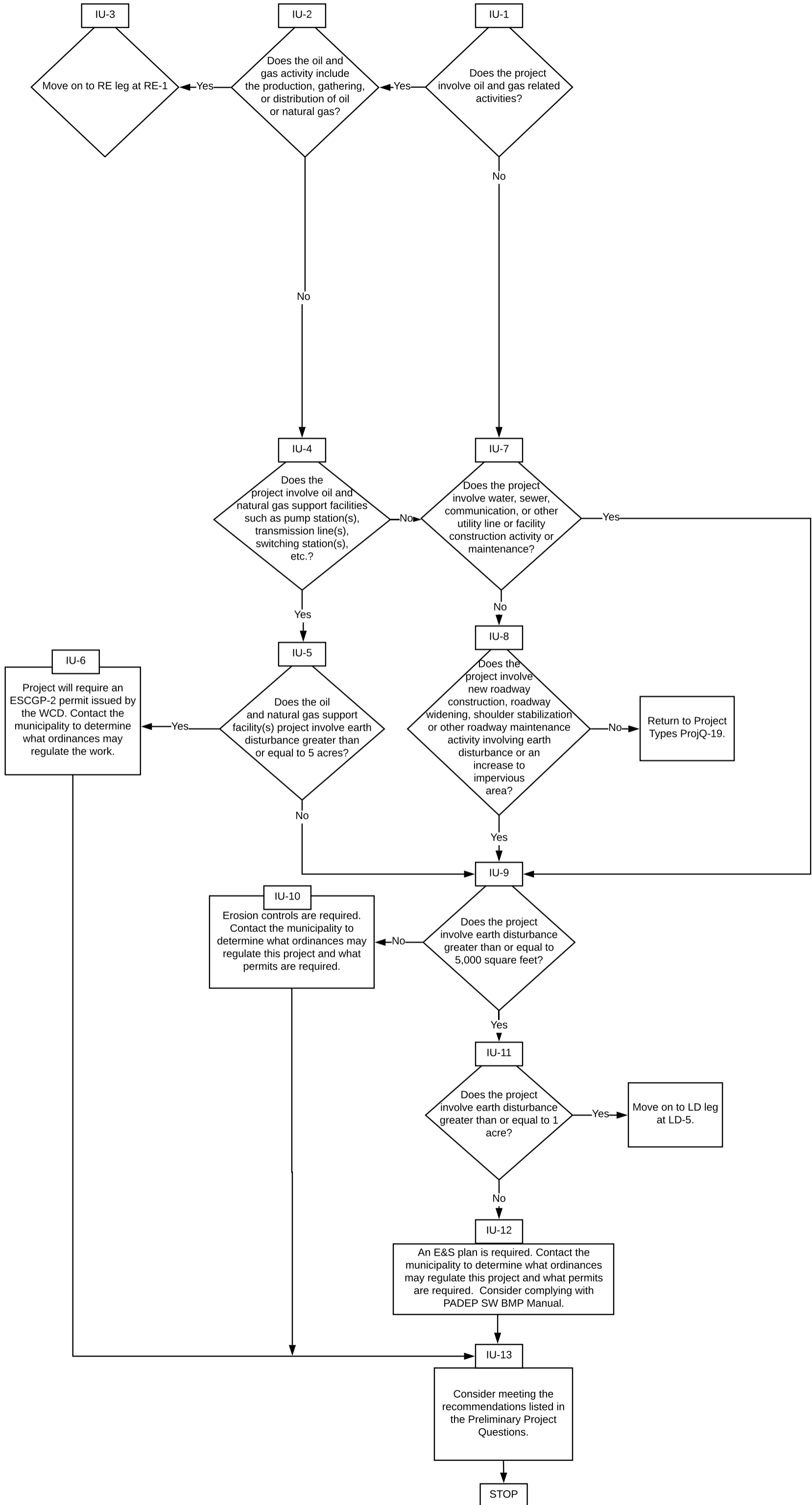

### Agriculture (AG)

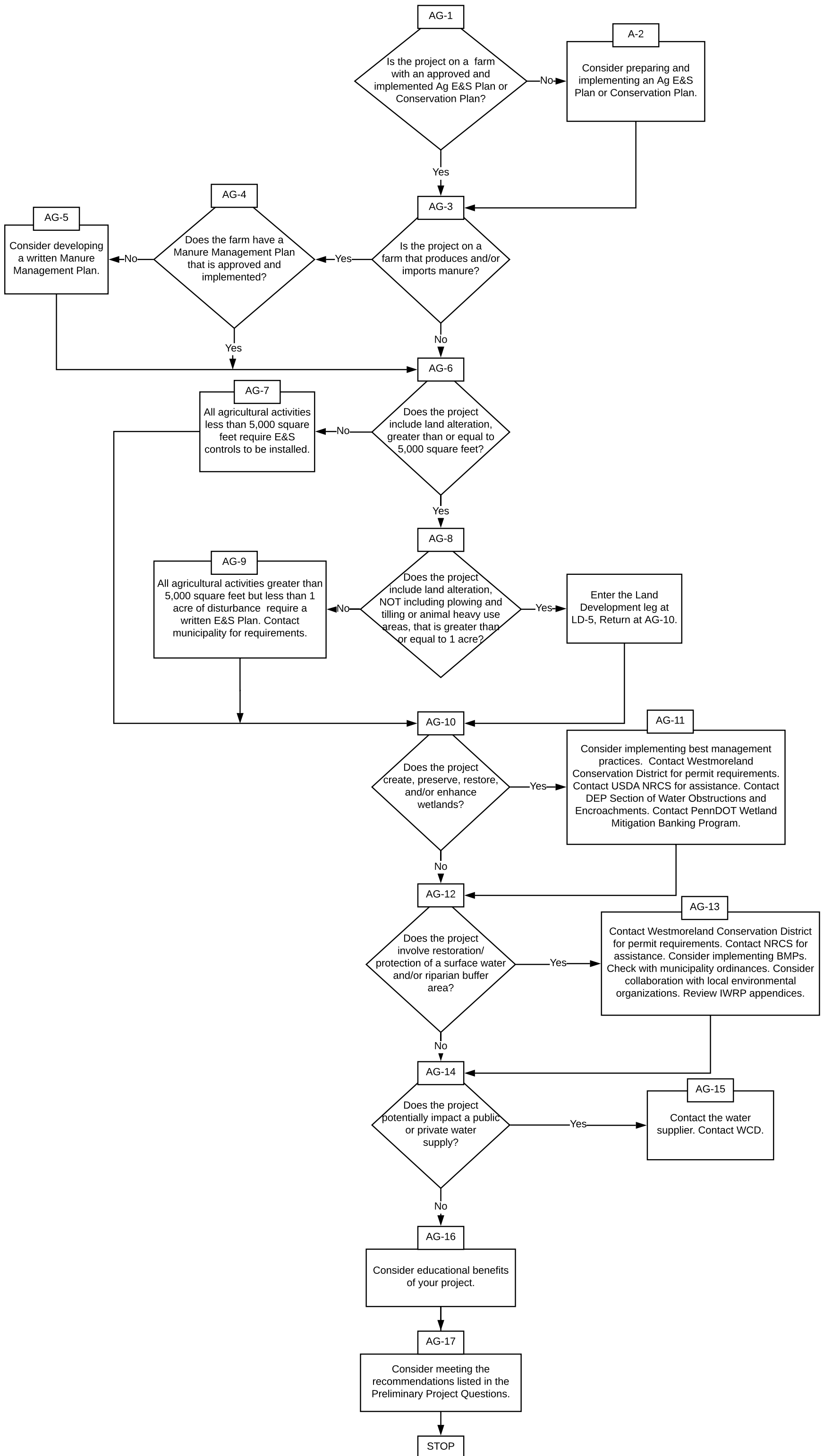



### Land Development (LD)

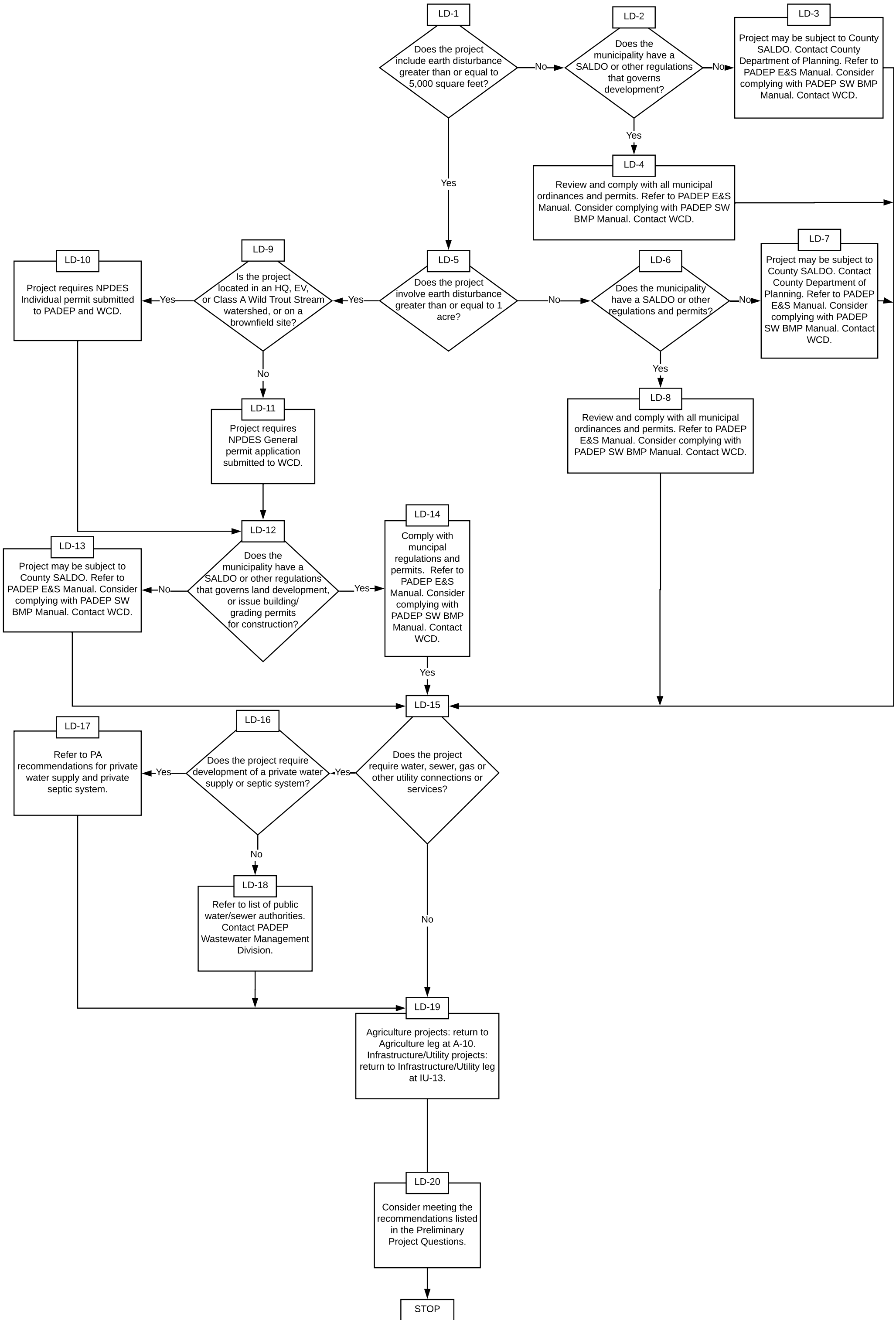

# Resource Extraction (RE)

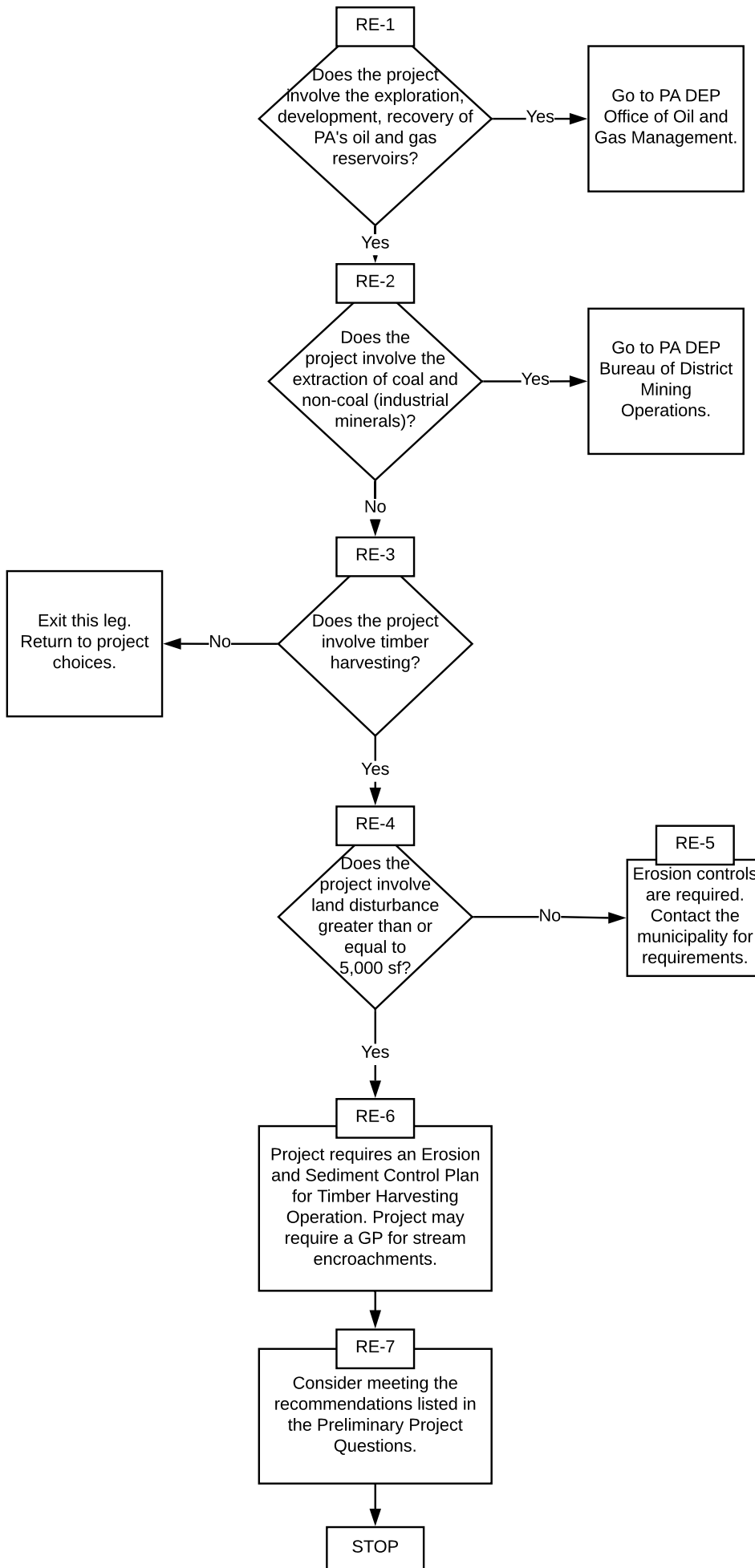



# APPENDIX D

## BMP Portfolio & Maintenance Guidelines

The entire set may be found at

<https://www.wcdpa.com>

Westmoreland County Integrated Water Resources Plan

## APPENDIX E

# Homeowner's Guide to Stormwater Management/Toolkit

The entire set may be found at

<https://www.wcdpa.com>



Westmoreland County Integrated Water Resources Plan

## APPENDIX F

### Resource Library

The entire resource library may be found at

<https://www.westmorelandstormwater.org/resource-library/>

Library: a summary of resources and links available for reference

## **Regulatory**

PA DEP Stormwater Regulations, Act 167

<http://www.dep.pa.gov/Business/Water/CleanWater/StormwaterMgmt/Pages/Act-167.aspx>

PA DEP NPDES Program

<http://www.dep.pa.gov/Business/Water/CleanWater/WastewaterMgmt/Pages/NPDESWQM.aspx>

EPA NPDES Program

<https://www.epa.gov/npdes>

PA DEP MS4 Online Mapping Tool

<http://www.depgis.state.pa.us/MS4/index.html>

PA DEP Library

<http://www.depgreenport.state.pa.us/elibrary/?aspxerrorpath=/elibraryredirect/dsweb/HomePage>

## **Research**

Villanova Urban Stormwater Partnership

<http://www1.villanova.edu/villanova/engineering/research/centers/vcase/vusp1.html>

Center for Watershed Protection

<https://www.cwp.org/>

University of New Hampshire Stormwater Center

<https://www.unh.edu/unhsc/>

Penn State Center for Dirt and Gravel Road Studies

<https://www.dirtandgravel.psu.edu/>

Interlocking Concrete Pavement Institute

<https://www.icpi.org/paving-systems/permeable-pavers>

Permeable Concrete, National Ready Mixed Concrete Association

<http://www.perviouspavement.org/>

Water Use and Water Rights in Pennsylvania

<http://www.perviouspavement.org/>



## Design

PA DEP Erosion and Sediment Control Manual

<http://www.depgreenport.state.pa.us/elibrary/GetDocument?docId=7700&DocName=363-2134-008.pdf>

PA DEP Stormwater BMP Manual

[http://www.dep.state.pa.us/dep/subject/advcoun/stormwater/manual\\_draftjan05/section06-structuralbmps-part1.pdf](http://www.dep.state.pa.us/dep/subject/advcoun/stormwater/manual_draftjan05/section06-structuralbmps-part1.pdf)

PennDOT Drainage Manual

<https://www.dot.state.pa.us/public/pubsforms/Publications/PUB%20584.pdf>

NRCS Conservation Catalog

[https://www.nrcs.usda.gov/Internet/FSE\\_DOCUMENTS/stelprdb1101559.pdf](https://www.nrcs.usda.gov/Internet/FSE_DOCUMENTS/stelprdb1101559.pdf)

EPA Online Training in Watershed Management

<https://www.epa.gov/watershedacademy/online-training-watershed-management>

## Local Organizations

Allegheny County Sanitary Authority

<http://www.alcosan.org/>

Pittsburgh Water and Sewer Authority

<http://www.pgh2o.com/>

3 Rivers Wet Weather

<http://www.3riverswetweather.org/#>

Turtle Creek Watershed Association

<http://www.turtlecreekwatershed.org/home.html>

Sewickley Creek Watershed Association

<http://www.sewickleycreek.com/>

Loyalhanna Watershed Association

<https://www.loyalhannawatershed.org/>

Mountain Watershed Association

<http://www.mtwatershed.com/>

Nine Mile Run Watershed Association

<https://ninemilerun.org/>

Westmoreland County Integrated Water Resources Plan

# APPENDIX G

## Watershed Plans



**Westmoreland Watershed Plans  
As of 2/2016**

**Allegheny River**

- Allegheny River Conservation Plan, 2005  
[http://www.dcnr.state.pa.us/cs/groups/public/documents/document/dcnr\\_001726.pdf](http://www.dcnr.state.pa.us/cs/groups/public/documents/document/dcnr_001726.pdf)
- Allegheny River Watershed Stewardship and Resource Guide
  - A supplement to the Allegheny River Conservation Plan, 2005

**Conemaugh River/ Kiskiminitas River**

- Kiski- Conemaugh River Conservation Plan, 2017
  - Kiski-Conemaugh Stream Team in process of updating plan.  
[http://www.dcnr.state.pa.us/cs/groups/public/documents/document/D\\_001868.pdf](http://www.dcnr.state.pa.us/cs/groups/public/documents/document/D_001868.pdf)
- Tubmill Creek Coldwater Conservation Plan, 2009  
<http://www.coldwaterheritage.org/docs/2007-grantees/tubmill-creek.pdf?sfvrsn=2>

**Loyalhanna Creek**

- Loyalhanna Creek Watershed Assessment and Restoration Plan, 2002-2003  
[http://www2.datashed.org/sites/default/files/lwa\\_plan\\_part\\_1\\_resized.pdf](http://www2.datashed.org/sites/default/files/lwa_plan_part_1_resized.pdf)

**Indian Creek**

- Upper Indian Creek Watershed Assessment Report, 2004
  - Upper Indian Creek Watershed (the headwater sub basin to the Indian Creek Watershed.)

**Jacobs Creek**

- Jacobs Creek Watershed Implementation and Restoration Plan, 2009  
<http://www.jacobs creek watershed.org/articles-reports/>

**Monongehela River**

- Monongahela River Watershed Initial Watershed Assessment September 2011 (Revised February 2012)  
[http://www.lrp.usace.army.mil/Portals/72/docs/HotProjects/signed%20IWA\\_final\\_revised%20FE B12%20public%20comments%20incorporated.pdf](http://www.lrp.usace.army.mil/Portals/72/docs/HotProjects/signed%20IWA_final_revised%20FE B12%20public%20comments%20incorporated.pdf)

**Pucketa Creek**

- Pucketa and Chartiers Watershed Assessment and Restoration Plan, 2005

**Sewickley Creek**

- Sewickley Creek Watershed Conservation Plan, 2003  
<http://waterlandlife.org/assets/Sewickley%20Creek%20Final%20WCP%20compressed.pdf>
- Donohoe Creek Watershed Protection and Restoration Plan, 2003
  - A sub basin to Sewickley Creek Watershed

**Turtle Creek**

- Turtle Creek Watershed River Conservation Plan, 2002  
[http://www.dcnr.state.pa.us/cs/groups/public/documents/document/D\\_001514.pdf](http://www.dcnr.state.pa.us/cs/groups/public/documents/document/D_001514.pdf)
- Turtle Creek Watershed Act 167 Stormwater Management Plan  
<http://www.wcdpa.com/bmp/TCWAct167SWMPlan.pdf>

**Youghiogheny River**

- River Conservation Plan of the Middle Youghiogheny River Corridor, 2000?  
[http://www.dcnr.state.pa.us/cs/groups/public/documents/document/D\\_001888.pdf](http://www.dcnr.state.pa.us/cs/groups/public/documents/document/D_001888.pdf)

## APPENDIX H

# Water Supply and Wastewater Treatment

- Water Authorities
- Sewage Authorities
- All About Private Water Supplies
- All About Private Septic Systems



**Water Authorities Serving  
Westmoreland County**

<b>Drinking Water Providers</b>	<b>General Service Area</b>	<b>Source of Water</b>	<b>Location of Filtration Plant(s)</b>	<b>Number of Customers</b>	<b>Gallons of Water Treated/day</b>
MAWC	Westmoreland County	Beaver Run Reservoir & Youghiogheny River	Bell Township	50,000	24,000,000
			South Connellsville (Indian Creek)		40,000,000
Highridge (Blairsville)	Northern Westmoreland County	Mountain springs near Seward and New Florence	Blairsville	5,209	1,771,013
Latrobe Municipal Authority	Greater Latrobe Area	H.A. Stewart Reservoir	Latrobe	9,500	6,000,000
Derry Boro Municipal Authority	Derry Township, Borough	McGee Run Reservoir and Ethel Springs Reservoir	Derry Township, Borough	2,500	600,000
Ligonier Township Water Authority	Ligonier Township	Reservoir above Waterford (South Branch Creek)	Ligonier Township	2,070	375,000
Municipal Authority of New Kensington	Greater New Kensington Area	Allegheny River	New Kensington	47,800	8,000,000
Youngstown Borough Municipal Authority	Youngstown Borough	Latrobe Municipal Authority	N/A (Latrobe)	850	N/A
Indian Creek Valley Water Authority	Donegal, Mount Pleasant and Donegal Borough	Pritts Spring, Grimm Spring & Neal Run Well	Indian Head	7,000	411,032
Borough of Charleroi Authority	Rostraver Township & Monessen	Monongahela River	Charleroi	11,196	6,000,000
Wilksburg Penn Joint Water Authority	Western Westmoreland County	Allegheny River	Pittsburgh	40,000	22,000,000

**Sewage Authorities Serving  
Westmoreland County**

<b>Sewage Authority</b>	<b>Sewage Treatment Plant (STP)</b>	<b>General Service Area</b>	<b>Location of STP</b>	<b>Number of Customers</b>	<b>Hydraulic Capacity (Gallon/Day)</b>
	Hempfield Park Sewage Treatment	Hempfield Park	Greensburg	1	5,000
	I-70 Industrial Park Sewage Treatment Plant	Industrial Park in Smithton	Smithton	11	50,000
	Sewickley STP	Sewickley Twp	Irwin	1,210	440,000
	Avonmore Borough Sewage Treatment Plant	Avonmore Boro	Avonmore	437	190,000
	Youngwood Borough Sewage (MAWC)	Youngwood Boro, Hempfield Twp	Youngwood - bought by MAWC	1,429	500,000
	Ligonier WPCP	Ligonier Boro, Ligonier Twp	Ligonier	1,678	900,000
	Darragh Sewage Treatment Plant	Hempfield Twp, Arona Boro, etc	Darragh	2,257	1,120,000
	Jeannette WWTP	Jeannette, Penn Boro, Penn Twp, Hempfield Twp	Penn	5,694	3,300,000
	Hutchinson STP	Hutchinson	Hutchinson	147	44,000
Municipal Authority of Westmoreland County (MAWC)	New Stanton Sewage Treatment Plant	Hempfield Twp and surrounding areas	Hunker	9,722	7,200,000
Municipal Authority of the Borough of Smithton	Municipal Authority of the Borough of Smithton	Smithton	Smithton	188	32,500
Ligonier Township Municipal Authority	Ligonier Township Municipal Authority	Ligonier Township	Darlington	360	50,000
Tri-Community Sewage	Tri-Community Sewage	Bolivar Area		660	50,000-100,000
Derry Township Municipal Sewage Authority 694-2513	Derry Township Municipal Sewage Authority 694-2513	Derry Township	Rt. 217/ New Alexandria and Millwood, New Alexandria	Millwood, New Alexandria: 4,300	Millwood, New Alexandria: 80,000
Borough of Mount Pleasant Sewage	Borough of Mount Pleasant Sewage	Mount Pleasant Borough area	Mount Pleasant Borough	2,200	100,000
East Huntingdon Township Wastewater	East Huntingdon Township Wastewater	East Huntingdon	Iron Bridge		100,000
Municipal Authority of Belle Vernon	Municipal Authority of Belle Vernon	Belle Vernon	Belle Vernon	1,500	285,000
Derry Borough Sewer Authority	Derry Borough Sewer Authority	Derry Borough	Derry	1,150	600,000
Rostraver Township Sewage Authority	Rostraver Township Sewage Authority	Rostraver Township	West Newton	4,159	700,000
Westmoreland/Fayette Municipal Sewage Authority	Westmoreland/Fayette Municipal Sewage Authority	Scottdale, Everson and East Huntingdon	Scottdale	2,500	1,600,000
North Huntingdon Township Municipal Authority	North Huntingdon Township Municipal Authority	North Huntingdon Township	North Huntingdon (Turner Valley)		3,310,000
Western Westmoreland Municipal Authority	Western Westmoreland Municipal Authority	Irwin, Manor, North Irwin	North Huntingdon	38,800	4,040,000
Franklin Township Municipal Sanitary Authority	Franklin Township Municipal Sanitary Authority	Murrysville, Export, Delmont area	Meadowbrook Road - Murrysville	9,730	4,900,000
Mon Valley Sewage Authority	Mon Valley Sewage Authority	Monossen & Donora	Donora		4,960,000
Latrobe Municipal Authority	Latrobe Municipal Authority	Greater Latrobe	Latrobe	10,000	5,000,000
Municipal Sanitary Authority of New Kensington	Municipal Sanitary Authority of New Kensington	New Kensington, Lower Burrell area, Arnold	Logans Ferry Road - New Kensington	13,000	6,000,000
GGSA	GGSA	Greater Greensburg Area	Greensburg	9,800	6,750,000
Kiski Valley Water Pollution Control Authority	Kiski Valley Water Pollution Control Authority	Kiski River Valley	near Leechburg, Allegheny Township	12,500	7,000,000
Unity Township Municipal Authority	Unity Township Municipal Authority	Unity Township	Pleasant Unity	7,000	7,000,000
Lower Burrell Municipal Authority (MSANK)	Lower Burrell Municipal Authority (MSANK)	Lower Burrell	(MSANK)		
Manor Borough Sewage Committee (WWMA)	Manor Borough Sewage Committee (WWMA)	Manor Borough	(WWMA)		
Mount Pleasant Township Municipal Authority	Mount Pleasant Township Municipal Authority	Mount Pleasant Township - Norvelt, Calumet, Hecla, United	Mount Pleasant Township - Brinkerton		
Municipal Authority of Allegheny Township	Municipal Authority of Allegheny Township	Allegheny Township	Leechburg		
Municipal Authority of Washington Township	Municipal Authority of Washington Township	Washington Heights	(Kiski)	1,500	
New Florence/St. Clair Township Sanitary Authority	New Florence/St. Clair Township Sanitary Authority	New Florence and St. Clair Township			
North Irwin Borough Municipal Authority	North Irwin Borough Municipal Authority	North Irwin	North Irwin		
Penn Township Sewage Authority	Penn Township Sewage Authority	Penn Township	Contracted to WWMA, Alcosan & Jeannette	5,724	
Seward/St. Clair Township Sanitary Authority	Seward/St. Clair Township Sanitary Authority	Seward and St. Clair Township		505	

## **Private Water Supply concerns...**

Private water wells are not regulated by PA DEP or the EPA. There are no statewide construction or siting standards for private well water. It is the responsibility of the homeowner to maintain the safety of the water in their well.

### Water Well Basics

PA DEP's website contains a lot of information that may answer homeowner's questions:

- Descriptions of microbiological and chemical contaminants with links to different treatment options. <http://www.dep.pa.gov/Citizens/My-Water/PrivateWells/Pages/Well-Contaminants-.aspx>
- Recommendations for getting your well tested. <http://www.dep.pa.gov/Citizens/My-Water/PrivateWells/Pages/Water-Testing.aspx>
- Clearinghouse of sites with information about well construction. <http://www.dep.pa.gov/Citizens/My-Water/PrivateWells/Pages/Well-Construction.aspx>
- Construction and maintenance information for drilling bedrock water wells. [http://www.docs.dcnr.pa.gov/cs/groups/public/documents/document/dcnr\\_006800.pdf](http://www.docs.dcnr.pa.gov/cs/groups/public/documents/document/dcnr_006800.pdf)
- Disinfection of wells. <http://www.dep.pa.gov/Citizens/My-Water/PrivateWells/Pages/Flooding-Resources.aspx>

The National Groundwater Association has videos and factsheets on water well basics, well construction, types of drilling methods, annual maintenance, water quality issues and testing, and hiring a water well contractor. <http://wellowner.org/>

The Shale Alliance for Energy Research developed a water well handbook to educate homeowners about their water supply is sited, how it functions, and how it should be maintained to protect water quality. [https://www.saferpa.org/Documents/Reports/PA-Water-Well-Handbook-01-15-2014\\_WebOptimized\\_FINAL.pdf](https://www.saferpa.org/Documents/Reports/PA-Water-Well-Handbook-01-15-2014_WebOptimized_FINAL.pdf)

Penn State Extension has a list of frequently asked questions about private water wells. <https://extension.psu.edu/private-water-systems-faqs>

### Finding a Well Driller

Pennsylvania law requires that well drillers have a license, but that does not mean that the driller has knowledge of proper drilling or well construction practices. PA DCNR keeps a list of all licensed water well drillers. <http://www.dcnr.pa.gov/Business/WaterWellDrillersLicensing/LicensedWaterWellDrillers/Pages/default.aspx>

The National Groundwater Association has a voluntary certification program for well drillers. It requires that the well driller pass technical exams and have 24 months of groundwater contracting experience. They also must obtain continuing education credits annually. (Note that a lack of certification does not mean that a driller cannot properly drill and construct a well.) The National Groundwater Association keeps a list of certified professionals. <http://wellowner.org/finding-a-contractor/certified-ground-water-contractors/>

### Drilling Your Well



Penn State Extension offers a guide on drilling a new well. It covers siting your well location, selecting a driller, and what you need to have in your contract with the driller. It lists what information you need to know before buying a home with a well and describes the components of a properly constructed well. <https://extension.psu.edu/drilling-a-new-well>

Penn State Extension also has a booklet called *A Guide to Private Water Systems in Pennsylvania – A Manual for Rural Homeowners on the Proper Construction and Maintenance of Private Wells, Springs, and Cisterns*, available for order for \$10. The booklet covers water system planning, proper construction and management of private water wells, wellhead protection, water testing and interpretation, and options for solving your water quality problems. <https://extension.psu.edu/a-guide-to-private-water-systems-in-pennsylvania>

#### Protecting Your Well from Contaminants

Annual water well inspections by a water well professional are important for the proper maintenance of the well. The Groundwater Association provides a list of things that a homeowner can inspect on their own. <http://wellowner.org/water-well-maintenance/annual-checkup/>

The Pennsylvania Water Resources Education Network (WREN), a project of the League of Women Voters of Pennsylvania Citizen Education Fund, operates a clearinghouse of information on source water protection. Well protection information can be found here. [www.sourcewaterPA.org](http://www.sourcewaterPA.org)

#### Statistics

More than 1 million private wells exist in PA and about 20,000 new wells are drilled each year. (Penn State Extension)

The total withdrawal of ground and surface water in PA is nearly 10 billion gallons per day (Penn State Extension).

## **Private Septic System concerns.....**

Septic systems that are improperly sited, poorly constructed, and not adequately maintained can contaminate both public and private drinking water wells. Therefore, it is recommended that you hire a professional soil scientist to determine what type of onlot system your property can support. Then, you can work with your local Sewage Enforcement Officer (SEO) to get the necessary permits.

### Background Information

For background information about how septic systems work, where to site them, how to properly operate and maintain them, as well as what signs to look for in a failing system, visit:

[www.sourcewaterPA.org/?\\_id=2632](http://www.sourcewaterPA.org/?_id=2632)

PA DEP's Onlot System Operation and Maintenance (Homeowner's Guide) describes how a septic system functions, signs that indicate the system is in trouble, what to do to prevent malfunctions, and suggests frequency of pumping your system tank. It also suggests tips for conserving water to lessen the burden on your system. <http://www.dep.pa.gov/Citizens/My-Water/SepticSystems/Pages/default.aspx> or

[http://www.dep.state.pa.us/dep/deputate/watermgt/wqp/wqp\\_wm/facts/pa1608.htm](http://www.dep.state.pa.us/dep/deputate/watermgt/wqp/wqp_wm/facts/pa1608.htm)

Pennsylvania's Onlot Disposal Program, known as the Act 537 program, requires proper planning of sewage facilities, uniform standards for designing septic systems, and permitting of those facilities. Information about the Act 537 program is described here: (Note some bad links on this page).

<http://www.dep.pa.gov/Business/Water/CleanWater/WastewaterMgmt/Act537/OnlotDisposal/Pages/default.aspx>

All municipalities must develop and implement comprehensive official plans related to their current and future sewage disposal needs, known as an Act 537 Plan. The status of each municipal plan in Westmoreland County can be found here:

[http://files.dep.state.pa.us/Water/BPNPSM/WastewaterManagement/Act537/PlanStatusMaps/SWRO\\_PlanAges.pdf](http://files.dep.state.pa.us/Water/BPNPSM/WastewaterManagement/Act537/PlanStatusMaps/SWRO_PlanAges.pdf)

When a new land development project is proposed, municipalities are required to revise their plans. Planning forms to make those revisions are found here:

<http://www.dep.pa.gov/Business/Water/CleanWater/WastewaterMgmt/Act537/Pages/Sewage-Facilities-Planning.aspx>

### Sewage Enforcement Officer

A sewage enforcement officer is an individual who works for a local agency (municipality, multi-municipal organization, or county), but is trained by DEP and certified by the State Board of Certification of Sewage Enforcement Officers. The local SEO can determine what onlot system is appropriate for a site, issues permits for an onlot system, and investigates complaints.

The powers and duties of an SEO are described here:

<http://www.pacode.com/secure/data/025/chapter72/s72.41.html>

The administration of the sewage facilities program, including PA Code Chapters 71, 72, and 73, is described here:

<http://www.dep.pa.gov/Business/Water/CleanWater/WastewaterMgmt/Act537/Pages/SewageFacilities.aspx>

#### Buyer/Builder Information

PA DEP provides helpful information to the home buyer/builder in their Onlot Sewage Program (Home Buyer's/Builders Guide) Factsheet (per Act 537 of 1966). Here, you will read what to look for in a property before you buy it, how to work with your local sewage enforcement officer, and what steps are needed to getting your permit. It lists the types of onlot systems, and provides a list of alternate systems to consider if your lot does not qualify for a conventional system. Note that you will need to hire a professional soil scientist to evaluate your site to determine which alternate system you can use.

[http://www.dep.state.pa.us/dep/deputate/watermgt/wqp/wqp\\_wm/FACTS/pa1607.htm](http://www.dep.state.pa.us/dep/deputate/watermgt/wqp/wqp_wm/FACTS/pa1607.htm)

PA Chapter 73 Standards for Onlot Sewage Treatment Facilities outlines the location and absorption requirements, the standards for septic tanks, specifications for building sewers, the dosing and distribution requirements, construction of absorption areas, standards for holding tanks, criteria for experimental and alternate systems, requirements for a bonded disposal system, and standards for individual spray irrigations systems.

<http://www.pacode.com/secure/data/025/chapter73/s73.161.html>

When a site cannot support a traditional septic system, a small flow treatment facility may be an option. PA DEP's Small Flow Treatment Facilities Manual (TECHNICAL GUIDANCE NUMBER 362-0300-002, dated 2006) provides information on the design, permitting, installation, operation, and maintenance of small flow facilities that may serve single-family residences, duplexes, and small commercial establishments that generate 2,000 gallons per day or less of domestic wastewater. This type of system will require an NPDES permit issued by DEP.

<http://www.elibrary.dep.state.pa.us/dsweb/Get/Document-108252/362-0300.002.pdf>

#### Seller Information

There are no state regulations concerning the sale of a house with an onlot system. However, some municipalities and some mortgage companies require testing the system at the point of sale. Contact your local municipality to see if they have any requirements.

#### Problems with a Neighbors' Faulty System

If a neighbor's faulty onlot system is causing you problems, contact the local municipality. Each municipality has an SEO as well as a back-up SEO who can investigate the complaint.



## APPENDIX I

### Chapter 5. Watershed and Pollutant Modeling Methodology

Prepared by Ethos Collaborative LLC  
(<http://www.ethoscollaborative.com/>) for  
Westmoreland Conservation District

- Methods and Data Analysis
- Soil Key Descriptions
- Streamstats Data for Modeled Areas of Interest (AOI)
- Watershed and Pollutant Modeling Task Matrix (prepared by WCD)

## Appendix: Methods and Data Analysis

### *Westmoreland County Areas of Interest Modeling Methodology*

The following Areas of Interest (AOI's) in the county were selected for focused studies (Figure 1). These areas were previously identified in the IWRP Phase 1 plan as regions of interest because of their high potential for future growth that would impact stormwater planning, known flooding issues, ongoing rapid growth, or inadequate infrastructure.

1. Turtle Creek- Watershed draining to the USGS gauge in Wilmerding
2. Kiskiminetas – Beaver Run watershed draining to the Beaver Run Reservoir
3. Monongahela – Watershed drained by Speer's Run
4. Sewickley Creek – Watershed
5. Loyalhanna Creek – Watershed draining to creek above the junction with Union Run Below Latrobe
6. Conemaugh – McGee Run watershed, to the confluence with Harbridge Run

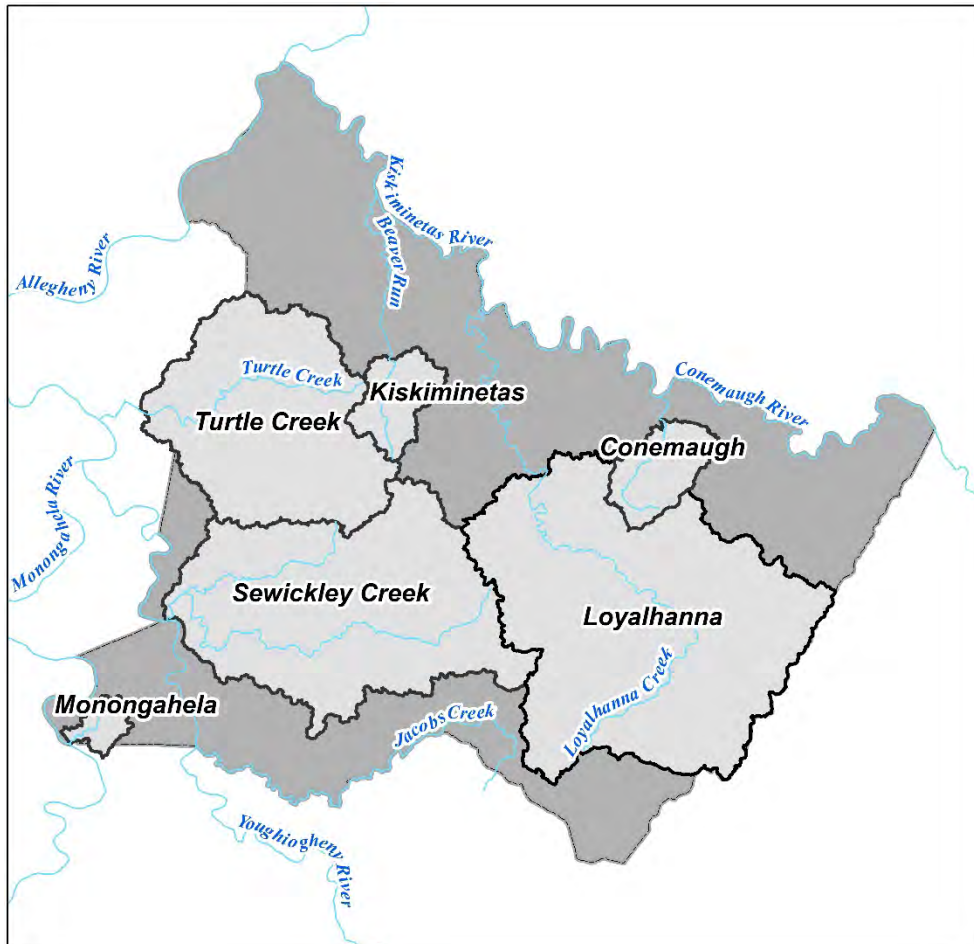

Figure 1: Westmoreland County with the major rivers and modeled Areas of Interest highlighted.

### *Environmental Data: CN's, Soil, Stream Discharge, and Rainfall*

CN, or Curve Numbers were calculated using the Land Cover NLCD and the Hydrologic Soil Group county GIS layers. To generate the CNs, each Land Cover class was matched with a NRCS (1986) classification (Table 1). This classification was then spatially matched to specific soil data downloaded from the Pennsylvania Spatial Data Access (PASDA) website managed by Penn State (Pennsylvania State University, n.d.). Soil data was downloaded for Westmoreland County, Allegheny County, and Fayette County, as some of the modeled regions extended outside of the county boundary. Each watershed was sub-divided to an appropriate level for modeling efforts, usually creating an area between 0.5-3 miles. Other identified areas in Phase I were not modeled because they were not single drainages and/or had significant area outside of Westmoreland County.

For Turtle Creek, Kiskiminetas, Sewickley, Monongahela, and Conemaugh AOI's, we conducted detailed hydrological/numerical modeling to calculate release rates. The results of the numerical modeling were used to provide information on the impact of land development on rainfall-runoff response, from the watershed uplands to the lower reaches. For all of the above watersheds, we conducted modeling that estimated the potential export of Suspended Sediment, Nitrate, and Phosphorus. This modeling process took into account the distributed landscape-based contributions of pollution on downstream communities.

### *Hydrologic modeling: Technical Approach*

We performed hydrologic modeling for specific areas of interest identified by the Westmoreland County Conservation District in order to meet the requirements of the ACT 167 planning effort. Hydrologic models were developed based on a commonly and widely applied approach using the unit hydrograph theory and the SCS Curve number described in the USDA TR-55 (Soil Conservation Service, Conservation Services Division 1986, 55) and the USDA National Engineering Handbook (Soil Conservation Service 1985). The numerical modeling was performed using HEC-HMS, the U.S. Army Corps of Engineers (USACE) Hydrologic Modeling System (US ACE 2016). GEO-HMS (a GIS extension that allows for the manipulation of spatial data and direct import/export to HEC-HMS) was used in conjunction with HEC-HMS (US ACE, n.d.).

### *Watershed Data – Land-use, Slopes, Elevations*

All spatial watershed data used in the models was downloaded from Pennsylvania Spatial Data Access (PASDA), the Pennsylvania Geospatial Data Clearinghouse ([www.pasda.psu.edu](http://www.pasda.psu.edu)), except for the parcel data obtained from Westmoreland County. Land-use data was obtained from the National Land Cover Database, years 2001, 2006, and 2011 (Fry et al. 2011; Homer et al. 2007, 2011). We used Digital Elevation Model (DEM) data from the PAMAP collection of high-resolution digital aerial photographs and LIDAR data (PA DCNR 2003). Slopes, sub-watersheds and stream reaches were developed from the DEM using tools and analysis available through ARC-GIS.



ide the boundaries of Westmorland County (Soil Survey Staff, Natural Resources Conservation Service n.d.). Slopes and other parameters specific to each sub-basin were calculated using tools in ARC-GIS.

*Table 1: National Land Cover Database (2001) classifications, matching corresponding Natural Resources Conservation Service (NRCS) classification, and assigned CN based on the Hydrological Soil Group (HSG) classification of the soil.*

<b>NLCD (2001) Land Use</b>	<b>NRCS (1986) Classification</b>	<b>A</b>	<b>B</b>	<b>C</b>	<b>D</b>
Open Water	Water, Assumed To Be Effectively Impervious	100	100	100	100
Developed, Open Space, <20% Impervious	Residential districts by average lot size, 1 Acre	51	68	79	84
Developed, Low Intensity, 20-49% Impervious	Residential districts by average lot size, 1/2 Acre	54	70	80	85
Developed, Medium Intensity, 50-79% Impervious	Residential districts by average lot size, 1/4 Acre	61	75	83	87
Developed, High Intensity, 80-100% impervious	Impervious Areas, Paved parking lots, etc., Streets and roads	98	98	98	98
Barren Land (Rock/Sand/Clay)	Fallow, Bare Soil	77	86	91	94
Deciduous Forest	Woods; Good Condition	32	58	72	79
Evergreen Forest	Woods; Good Condition	32	58	72	79
Mixed Forest	Woods; Good Condition	32	58	72	79
Grassland/Herbaceous	Meadow	30	58	71	78
Pasture / Hay	Pasture, Grassland; Good Condition	39	61	74	80
Cultivated Crops	Small Grain; Contoured (C); Good Condition	61	73	81	84
Woody Wetlands	Woods; Fair Condition	36	60	73	79
Emergent Herbaceous Wetland	Water, Assumed To Be Effectively Impervious	100	100	100	100

Stream Discharge data was actively measured in three places in the watershed: USGS Gage 03084698, located on Turtle Creek in Wilmerding, PA; a Westmoreland Conservation District-installed gage located on Loyalhanna Creek in Ligonier, and a Westmoreland Conservation District-installed gage on Sewickley

Creek. In the Turtle Creek watershed, we first used the USGS gage data to validate and calibrate the HEC-HMS model. We then compared the results from the HEC-HMS model to StreamStats for different stream reaches (Figure 2). StreamStats, a Web application that provides access to an assortment of Geographic Information Systems (GIS) analytical tools, predicts the hydrological response of a watershed draining to a user-chosen Point of Interest (USGS, n.d.). Comparing StreamStats models to the actual discharge data measured in Turtle Creek allowed us to determine the feasibility of using StreamStats discharge data, in the absence of gages throughout the watershed. This was particularly important in watersheds without stream gages installed in them.

Figure 2: Calibration sites in the Turtle Creek watershed where StreamStats discharge data and Modeled discharge data were compared for the 2, 5, 10, 50, and 100 year storms

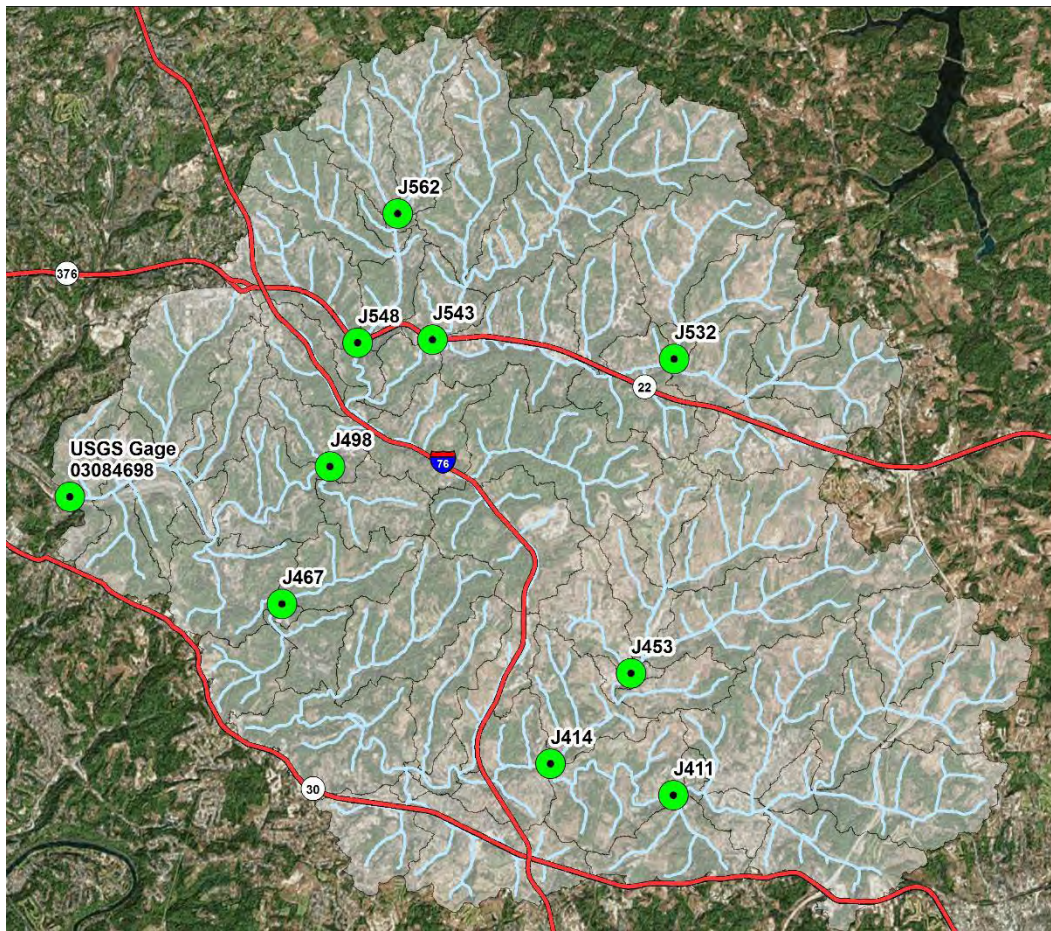

Figure 3 below compares StreamStats and the hydrological model discharge results at selected sites in the Turtle Creek Area of Interest for the 2, 5, 10, 50, and 100 year storms. There is a good correlation between model results and Streams Stats data, which suggests this is a reasonable approach mitigate to the lack of discharge data in other watersheds.

Figure 3: Modeled versus StreamStats discharge data for selected sites.



### Rainfall

Rainfall data used in this study includes the following: i) spatially variable gridded hourly rainfall depths datasets for historical events, and ii) Design storms 24-hour rainfall depth estimates for return periods between 2 and 100-years provided by NOAA Atlas 14 (NOAA National Weather Service, n.d.).



### *Hydrologic Model Parameters and Calibration*

The following main parameters were included in the hydrologic models: subwatershed area, CN number, time of concentration (Tc), reach lengths and slopes, reach cross-sectional dimensions, and rainfall depths.

Gridded precipitation data obtained from NOAA allowed us to build a model that was spatially distributed across the landscape and utilized HEC-GeoHMS. The gridded precipitation model used the following methods: i) loss: Gridded SCS Curve Number, ii) Transform: ModClark, iii) Baseflow: Recession, iv) Routing: Muskingum-Cunge. A list of the parameters associated with each one of these methods is presented below.

*Table 2: HEC-HMS modeling method parameters*

<b>Method Parameters</b>	
<b>Loss: Gridded SCS Curve Number</b>	<b>CN, Initial Abstraction Ratio, S Factor</b>
<b>Transform: ModClark</b>	<b>Time of Concentration, Storage Coefficient</b>
<b>Routing: Muskingum-Cunge</b>	<b>Manning's Roughness Coefficient (n) for channel, right bank and left bank</b>
<b>Baseflow: Recession</b>	<b>Discharge per unit area, Recession Constant, Ratio to peak discharge</b>

When appropriate, model parameters used to calibrate for Loss: Gridded Curve Number and Transform: ModClark methods were defined seasonally, with different values selected for summer (May to October) and winter (November to April) conditions. These parameters include: the Initial Abstraction Coefficient, the S-multiplication factor, and Storage Time. The Storage Time was defined as a function of the Time to concentration (Tc) and the area of the watershed covered by ponds and lakes.

Numerical models prepared for each watershed simulated both existing conditions and future scenarios. The future scenarios were developed based on predicted land development to occur over the next 25 years. The models were initially calibrated and validated for historical storms, in the case of watersheds where water discharge data was available. The models were also used to run SCS 24-hour Type II synthetic storms under both existing and future land cover conditions

Table 3: Design Storm Recurrence Intervals and Associated Rainfall Depths

<b>Design Storm (years)</b>	<b>Type II, 24-hr Rainfall Depth (in)</b>
<b>2</b>	<b>2.39</b>
<b>10</b>	<b>3.35</b>
<b>25</b>	<b>3.96</b>
<b>50</b>	<b>4.46</b>
<b>100</b>	<b>4.99</b>

### Hydrologic Model Calibration and Validation

We calibrated and validated the HEC-HMS modeling process with data gathered from the Turtle Creek watershed. This watershed, which contains an operating USGS discharge gauge (located in Wilmerding), provided solid data to calibrate and validate the HEC-HMS models. Below, modeled versus measured discharge (CFS) for 2, 5, 10, 25, 50, and 100 year storm events offer evidence that the model estimates large flows well, when compared to measured large flows. Calibration parameters obtained while running the Turtle Creek model provided the starting point necessary to model the remaining watersheds. Calibration data for individual Areas of Interest is available in the focus chapter for each of these.

### Statistical Comparison: Model Results versus Gauge Results for Specific Storm Events

Statistical evaluation of individual storms allowed us to quantify the degree of difference between model results and measured data for large storm events in the Turtle Creek watershed.

- **Pearson’s Correlation Coefficient (*r*)** measures the strength of a relationship between two variables. The “*r*” values shown below indicate a very strong positive relationship between modeled and measured discharge values.
- **Percent Bias (*PBIAS*)** calculates the difference between the mean (average) of the model versus the gage data. In general, it provides an estimate of how the model over or under predicts the actual data.
- **Nash-Sutcliffe efficiency (*NSE*)**, assess model accuracy, where the closer the *NSE* is to 1, the closer the model is to actual data. In the chart below, the calculated *NSE* ranges from 0.97 to 0.40.

Table 4: Statistical analysis of modeled versus measured discharge for individual storm events in Turtle Creek

<i>Event</i>	<i>Pearson's Correlation Coefficient (r)</i>	<i>Percent Bias (PBIAS)</i>	<i>Nash-Sutcliffe efficiency (NSE)</i>
<i>Ivan 2004</i>	<b>0.99</b>	<b>-4%</b>	<b>0.97</b>
<i>June 2013</i>	<b>0.98</b>	<b>0%</b>	<b>0.95</b>
<i>July 2013</i>	<b>0.97</b>	<b>-28%</b>	<b>0.88</b>
<i>Sandy 2012</i>	<b>0.93</b>	<b>8%</b>	<b>0.87</b>
<i>August 2007</i>	<b>0.93</b>	<b>3%</b>	<b>0.85</b>
<i>January 2005</i>	<b>0.99</b>	<b>0%</b>	<b>0.98</b>
<i>January 2013</i>	<b>0.95</b>	<b>-15%</b>	<b>0.88</b>

When combined with the actual storm hydrographs, these statistical parameters help to define the degree to which HEC-HMS over or under-predicts the data. For example, the hydrograph for the July 2013 storm (Figure 2) shows that the blue modeled data line is largely under the red gage line. The “r” value for this storm (Table 4) indicates good correlation between the data. The Percent Bias of -28% indicates that the model is under predicting, and the NSE is 0.88, again suggesting overall that the model achieves a good degree of accuracy.



Figure 4: Selected storm hydrographs comparing modeled and USGS Gage discharge comparisons.

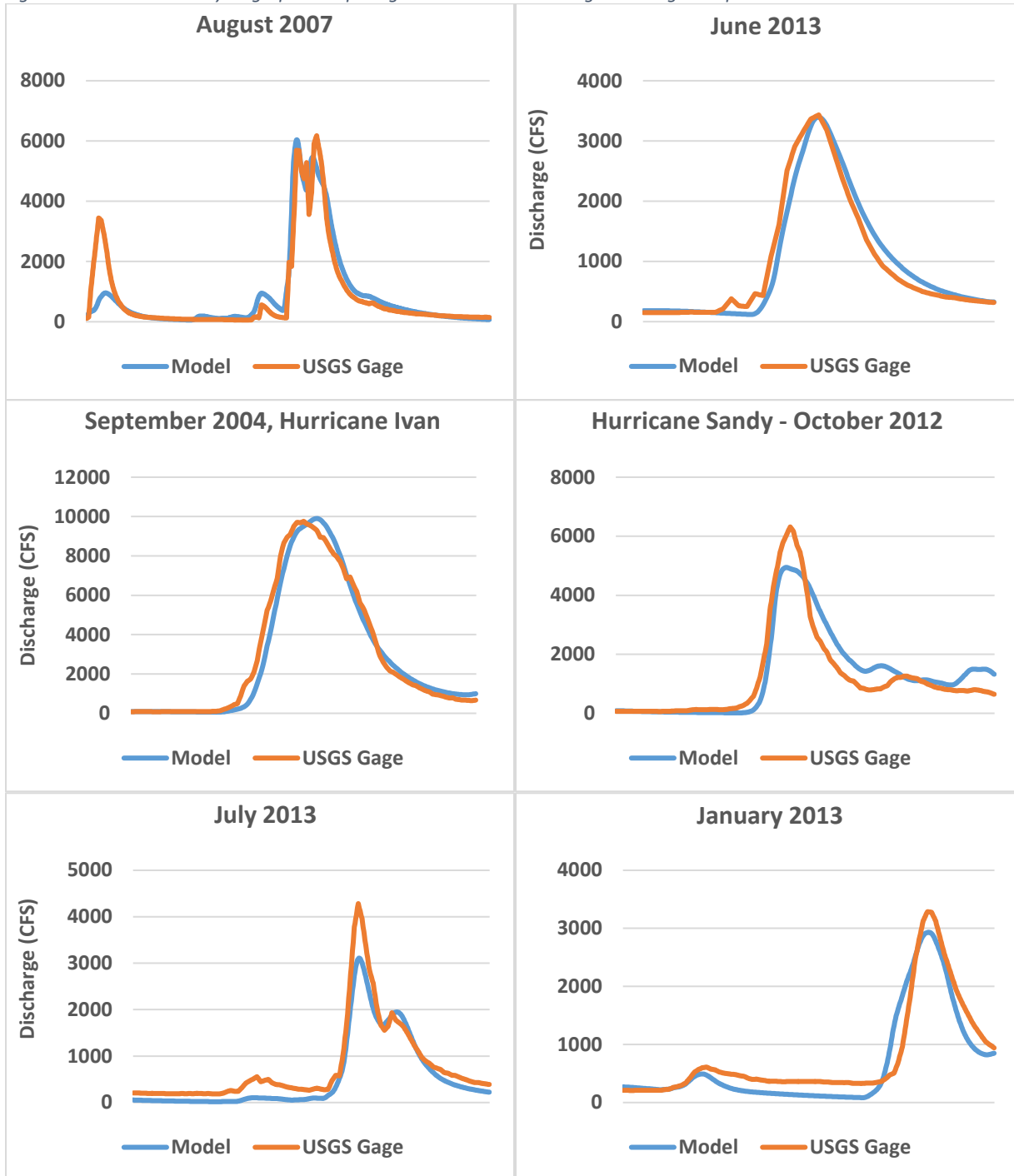

USGS StreamStats Regression Analysis flow estimates were used to finalize the calibration of the models. The USGS online Web application StreamStats provides access to Geographic Information Systems (GIS) analytical tools, spatial data, and modeling that can be used in water-resources planning applications, among others. This web application was used to delineate drainage areas for selected sites in the watershed, determine relevant basin characteristics, and estimate flow statistics. Data produced

by StreamStats (Version 4.2.0) was used as a comparison to modeled hydrological results, first in Turtle Creek as a comparison against the measured and modeled discharge data, then in each Area of Interest (Roland, M.A., and Stuckey, M.H. 2008) . This approach allowed us to calibrate hydrological models in the absence of multiple stream gage locations in the watershed (Stuckey, M.H. 2006; Roland, M.A., and Stuckey, M.H. 2008). Additional data can be found in Appendix A: StreamStats data for each area of interest

### **Release Rate Calculation**

Once the model for each watershed is developed, calibrated, and examined, the model is used to run and analyze runoff scenarios. These scenarios are meant to determine the runoff contribution of each sub-watershed to the peak discharge of the watershed as a whole. This process allows us to determine where, and by how much, the runoff from a particular area must be reduced in order to minimize the effect of development in the future. The concept of controlling the impact of discharged from a subwatershed contributing to the hydrologic response at a POI (point of interest) is quantified by release rates. For comprehensive stormwater management, outlet of every subwatershed should be treated as a POI.

Release rates were calculated using the methodology as described in Watersheds, Processes, Assessments, and Management (DeBarry 2004). Hydrographs produced through HEC-HMS models were used to extract inputs for release rate calculations. Release rates are calculated as the ratio of the watershed's flow at the time that POI experiences peak flow,  $Q_T$  and watershed's peak flow,  $Q_P$  (Figure 5).

Using this methodology, each subwatershed would have a QT for each POI they contribute to. Using this matrix, lowest calculated value is used as the release rate. This process is repeated for 1-, 2-, 5-, 10-, 25-, 50-, and 100- year storms.

Three things about the release rate calculations that are worth noting:

- (1) A subwatershed's release rate to its own POI should be 1 (100%).
- (2) Subwatersheds that peak after the POI does not require release rate calculations as they do not contribute to the POI peak.
- (3) Literature suggests three options to deal with release rates below 0.5 (50%): (1) assume no detention, (2) use a 50% release rate, (3) use the calculated release rate. While subwatersheds that require no detention can be identified easily, the determination of assigning 50% or assigning the actual values lower than 50% depends on economic feasibility. Values lower than 50% would require very stringent stormwater control measures. Therefore, for this analysis we chose option 2, and assumed that any subwatershed with a calculated release rate below 50% should be assigned a 50% release rate.

Figure 5: Release rate methodology using unit hydrographs

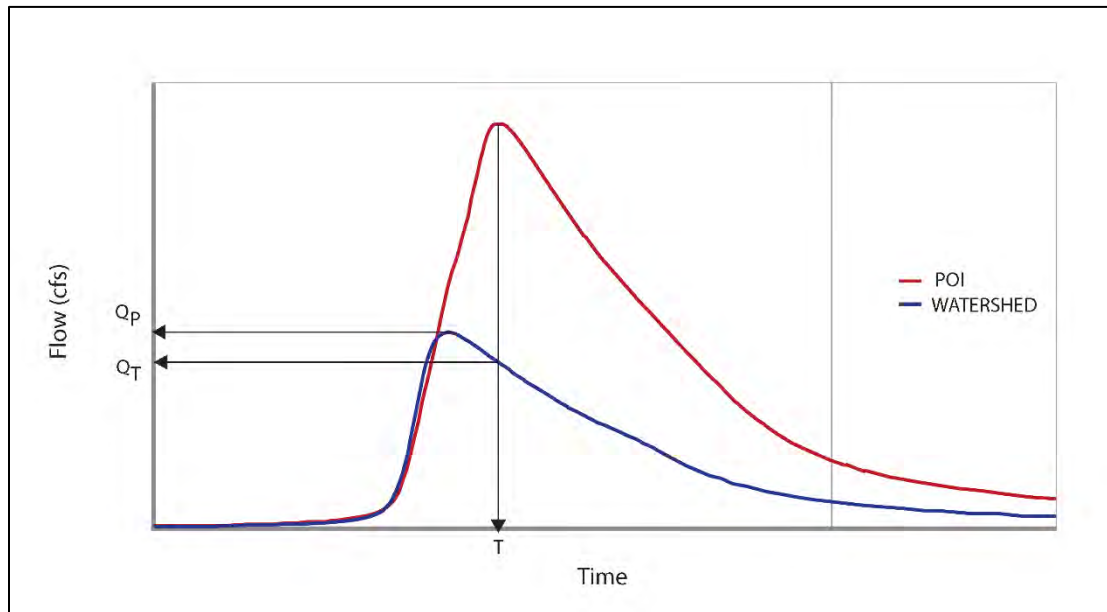

$$\text{Release Rate} = \frac{\text{Subwatershed predevelopment contribution to point - of - interest peak}}{\text{Subwatershed predevelopment peak flow}}$$



## *TSS and Nutrient Modeling Methodology*

Estimates for total suspended solids (TSS), total phosphorus (TP), and Nitrate (NO<sub>3</sub><sup>-</sup>) were generated using a modification of the Curve Number method and analyzed spatially/mapped using ArcGIS. It should be emphasized that this process was developed in order to relatively quickly, with a minimum of inputs, assess the potential flow paths and estimated accumulated contributions of Sediment, Phosphorus, and Nitrate from different land covers based on individual conditions within the watersheds.

The process estimated runoff for each pixel (approximate size 3 meters x 3 meters) based on a one inch rainstorm using the distributed runoff curve numbers (CN's) generated as part of the HEC-HMS modeling process (Soil Conservation Service, Conservation Services Division 1986).

The runoff (Q) is estimated by the following equation:

$$Q = \frac{(P - (0.2 * S))^2}{(P + (0.8 * S))}$$

Where:

*Q is runoff*

*P is rainfall/precipitation*

*S is the potential maximum soil retention after runoff begins*

The factor S, or the potential maximum retention is related to the dimensionless parameter CN in the range of 0 <= CN <= 100 by the following equation:

$$S = (1000/CN) - 10$$

Using the CN for each grid square/pixel calculated as part of the HEC-HMS process, we were able to estimate runoff, or "Q" for each pixel using ARC GIS analyst and calculator tools. We accumulated this runoff to represent an average year of rainfall (42 inches), then converted runoff depth to the expected yearly runoff volume from each pixel.

We then used ARC GIS spatial analysis to develop a grid of expected pollution concentrations based on the National Land Cover Database for 2011 (Homer et al. 2011). We resampled the NLCD 2011 data set to the same grid size as the runoff grid. We assigned an event mean concentration (EMC) to each landcover type in milligrams per liter for Nitrate, Total Phosphorus, and TSS by correlating the NLCD cover type with expected Event Mean Concentrations of pollutants (EMC's) from each landcover based on the data found in the TR-55 document and the National Research Council Report, Urban Stormwater Preliminary Data Summary (National Research Council Committee on Reducing Stormwater Discharge

Contributions to Water Pollution 2008; Soil Conservation Service, Conservation Services Division 1986). The grid containing the expected concentration of pollutants from each landcover type was multiplied by the grid containing the expected runoff to obtain an estimated weight (converted to lbs) of pollution exported by each pixel on a yearly basis. The concentrations (in mg/L) assigned to each landcover are shown in Table 5 below.

Table 5: NLCD Landcover, Corresponding TR-55 Description, and assigned estimates (event mean concentrations, in mg/L) of pollution concentration in runoff.

<b>NLCD 2001 Description</b>	<b>TR-55 Description</b>	<b>Total Suspended Sediment (mg/L)</b>	<b>Total Phosphorus (mg/L)</b>	<b>Total Nitrate (mg/L)</b>
Open Water	Water, Assumed To Be Effectively Impervious	0	0	0
Developed, Open Space, <20% Impervious	Residential districts by average lot size, 1 Acre	167	0.94	0.78
Developed, Low Intensity, 20-49% Impervious	Residential districts by average lot size, 1/2 Acre	147	0.82	0.77
Developed, Medium Intensity, 50-79% impervious	Residential districts by average lot size, 1/4 Acre	147	0.82	0.77
Developed, High Intensity, 80-100% impervious	Impervious Areas, Paved parking lots, etc., Streets and roads	261	0.4	0.83
Barren Land (Rock/Sand/Clay)	Fallow, Bare Soil	305	0.4	0.33
Deciduous Forest	Woods; Good Condition	39	0.15	0.17
Evergreen Forest	Woods; Good Condition	39	0.15	0.17
Mixed Forest	Woods; Good Condition	39	0.15	0.17
Grassland/Herbaceous	Meadow	47	0.19	0.3
Pasture / Hay	Pasture, Grassland; Good Condition	47	0.19	0.3
Cultivated Crops	Small Grain; Contoured (C); Good Condition	55	1.34	0.73
Woody Wetlands	Woods; Fair Condition	39	0.15	0.17
Emergent Herbaceous Wetland	Water, Assumed To Be Effectively Impervious	47	0.19	0.3

The resulting GIS data layers were used to model both accumulation and de-accumulation of waterborne pollutants as they moved across the landscape. Accumulation and decay modeling was done through the use of ARCGIS and the "TAUDEM" toolset developed by David Tarboton at Utah State

University with support from the Army Corps of Engineers (David Tarboton 2015). This Spatially-based tool set contains a suite of tools that determines hydrologic information from DEMs. Inputs include topographic information in the form of a digital elevation model, weighted raster grids representing pollution inputs, and landscape-based weighted decay grids. The decay grid was developed from NLCD datasets. Natural land cover such as grasslands or forests were assigned a pollution reduction value, under the assumption that these landcover types would act as pollution and water sinks. We assumed that pollutants would be reduced by 75% in these landcover types, based on the reduction values for various Best Management Practices evaluated as part of the PA DEP's Best Management Practices Manual (Department of Environmental Protection, Bureau of Watershed Management 2006).

The TAUDEM tools accumulated and reduced the pollution as the water moves across the landscape. The resulting data can be viewed as "pollution streamlines" across the landscape, or the pounds per acre can be calculated for each sub-watershed. This process allows for the quick identification of "hotspots" of pollution in the landscape, regions of significant export, and can help to pinpoint regions where BMP's may be particularly effective. Further, the data can be matched with vacant properties, park lands, and other publically-owned parcels in order to identify lands where BMP's may be more easily implemented.

We also evaluated the percent tree canopy in riparian buffers. We downloaded data detailing the amount of tree canopy across the landscape (Homer et al. 2011) and used spatial analysis tools from ESRI in the ARCGIS software to determine the percent tree canopy in the riparian buffer within either side of the stream corridors. This allowed use to quickly pinpoint the regions where tree canopy was sparse. These regions could then be evaluated as focus regions for restoration and/or tree planting efforts.

#### *Caveats/Limitations to these tools:*

Although this modeling effort provides useful data about landscape-wide Non-Point Source pollution loadings, the data should be used with some caveats in mind.



The data is limited by the spatial information available to obtain results. Spatial data often cannot recognize and correctly account for each landscape feature. For example, in Figure 2 the modeling produced stream buffers that run right through the middle of a building and parking lot. Available modeling methods cannot pinpoint regions where the stream is clearly culverted; in this situation the question of tree canopy in riparian buffers is clearly moot. Similarly, Figure 5 shows the flow lines draining into a stream network from the roads. However, it is highly likely that in this area the flow is actually captured by the storm sewer network, and may not be routed to the stream in this location. These examples highlight the limitations of the modeling process, and clearly illustrate that the methods described above should be used in conjunction with aerial photos and on-site observations, when necessary.



*Figure 6: Example of Riparian Buffer analysis that highlights stream course through parking lot. Yellow line indicates the likely stream course through culverts underground.*

It should be emphasized that this modeling method estimates the magnitude of pollutant loading, but accompanying field studies to validate these results have not been conducted. These methods do not calculate an exact lbs-per-year quantity. Rather, this process allowed us build data enough to understand the accumulation of pollutants and how the landscape can attenuate that accumulation. Therefore, this data should be used with this purpose, and the accompanying limitations, in mind. That being said, however, these final approximations of basin export and landscape export are within the range of estimates expected based on landcover type, as detailed in the EPA Urban Stormwater Preliminary Data Summary (National Research Council Committee on Reducing Stormwater Discharge Contributions to Water Pollution 2008).

## References

- David Tarboton. 2015. *Terrain Analysis Using Digital Elevation Models (TAUDEM)* (version Version 5). Hydrology Research Group, Utah State University.
- DeBarry, Paul. 2004. *Watersheds: Processes, Assessment, and Management*. Hoboken, New Jersey: John Wiley & Sons, Inc.
- Department of Environmental Protection, Bureau of Watershed Management. 2006. "Pennsylvania Stormwater Best Management Practices Manual." PA DEP.
- Fry, J, G Xian, S Jin, J.A. Dewitz, G.C. Homer, L Yang, C. Barnes, N.D. Herold, and J.D Wickham. 2011. "Completion of the 2006 National Land Cover Database for the Conterminous United States." PE&RS.
- Homer, G.C., J.A. Dewitz, J Fry, M Coan, N Hossain, C Larson, N.D. Herold, A McKerrow, J.N VanDriel, and J.D Wickham. 2007. "Completion of the 2001 National Land Cover Database for the Conterminous United States." Photogrammetric Engineering and Remote Sensing.
- Homer, G.C., J.A. Dewitz, L Yang, S Jin, P Danielson, G Xian, J. Coulston, N.D. Herold, J.D Wickham, and K Megown. 2011. "Completion of the 2011 National Land Cover Database for the Conterminous United States-Representing a Decade of Land Cover Change Information." Photogrammetric Engineering and Remote Sensing.
- National Research Council Committee on Reducing Stormwater Discharge Contributions to Water Pollution. 2008. "Urban Storm Water Preliminary Data Summary." Urban Stormwater Management in the United States. Washington, DC.  
[https://www.epa.gov/sites/production/files/2015-10/documents/nrc\\_stormwaterreport1.pdf](https://www.epa.gov/sites/production/files/2015-10/documents/nrc_stormwaterreport1.pdf).
- NOAA National Weather Service. n.d. *Precipitation Frequency Data Server*. Hydrometeorological Design Studies Center.
- PA DCNR. 2003. "Lidar Elevation Data - Digital Elevation Model." PAMAP.
- Pennsylvania State University. n.d. *PASDA (The Pennsylvania GeoSpatial Data Clearinghouse)*.  
<http://www.pasda.psu.edu/about.asp>.
- Roland, M.A., and Stuckey, M.H. 2008. "Regression Equations for Estimating Flood Flows at Selected Recurrence Inter-vals for Ungaged Streams in Pennsylvania." *U.S. Geological Survey Scientific Investigations Report 5102*: 57.
- Soil Conservation Service. 1985. "Hydrology, National Engineering Handbook." U.S.D.A., 1956, 1964, 1971, 1972, 1985.
- Soil Conservation Service, Conservation Services Division. 1986. "Urban Hydrology for Small Watersheds, TR-55." United States Department of Agriculture, Natural Resource Conservation Service.
- Soil Survey Staff, Natural Resources Conservation Service. n.d. "Web Soil Survey." Natural Resources Conservation Service, United States Department of Agriculture. Accessed October 1, 2017.  
<https://websoilsurvey.sc.egov.usda.gov/>.
- Stuckey, M.H. 2006. "Low-Flow, Base-Flow, and Mean-Flow Regression Equations for Pennsylvania Streams." *U.S. Geological Survey Scientific Investigations Report 5130*: 57.
- US ACE. 2016. *Hydrologic Engineering Cetner-Hydrologic Modeling System (HEC-HMS)* (version Version 4.2). <Http://www.hec.usace.army.mil/software/hec-hms/>.
- . n.d. *Hydrologic Engineering Center - Geospatial Hydrologic Modeling Extension (HEC-GeoHMS)* (version HEC-GeoHMS 10.2 for ArcGIS 10.2). <http://www.hec.usace.army.mil/software/hec-geohms/>.
- USGS. n.d. *StreamStats* (version 4). <https://water.usgs.gov/osw/streamstats/>.

## Appendix: Soil Key Descriptions

Soil map symbols referenced in the text are listed below. The specific soil description accompanies each map symbol.

Soil data for Westmoreland and relevant regions of Allegheny and Fayette Counties was downloaded from the Web Soil Survey, published online by the Natural Resources Conservation Service of the United States Department of Agriculture.

Soil Survey Staff, Natural Resources Conservation Service, United States Department of Agriculture. Web Soil Survey. Available online at the following link: <https://websoilsurvey.sc.egov.usda.gov/>. Accessed 12/29/2017.

<b>Map Symbol</b>	<b>Soil Name and Description</b>	<b>HSG Classification</b>
AIB	Albrights silt loam, 0 to 8 percent slopes, very stony	D
AID	Albrights silt loam, 8 to 25 percent slopes, very stony	D
At	Atkins silt loam, 0 to 3 percent slopes, frequently flooded	B
BeB	Bethesda very channery silt loam, 0 to 8 percent slopes	D
BeD	Bethesda very channery silt loam, 8 to 25 percent slopes	D
BeF	Bethesda very channery silt loam, 25 to 75 percent slopes	D
BkA	Brinkerton silt loam, 0 to 3 percent slopes	C
BkB	Brinkerton silt loam, 3 to 8 percent slopes	C
BrB	Brinkerton silt loam, 2 to 8 percent slopes	C
BuB	Buchanan loam, 0 to 8 percent slopes, extremely stony	D
BuD	Buchanan loam, 8 to 25 percent slopes, extremely stony	D
CaB	Cavode silt loam, 3 to 8 percent slopes	C
CaC	Cavode silt loam, 8 to 15 percent slopes	C
CeB	Cavode silt loam, 0 to 8 percent slopes, very stony	C
CeD	Cavode silt loam, 8 to 25 percent slopes, very stony	C
ChA	Chavies fine sandy loam, 0 to 2 percent slopes	A
CkC	Clarksburg silt loam, 8 to 15 percent slopes	C
ClB	Clarksburg silt loam, 3 to 8 percent slopes	C
ClC	Clarksburg silt loam, 8 to 15 percent slopes	C
CmB	Clymer silt loam, 3 to 8 percent slopes	B
CmC	Clymer silt loam, 8 to 15 percent slopes	C
CmD	Clymer silt loam, 15 to 25 percent slopes	B
CoB	Cookport loam, 0 to 8 percent slopes, very stony	C
CoD	Cookport loam, 8 to 25 percent slopes, very stony	C
CrB	Craigsville-Buchanan complex, 0 to 8 percent slopes, extremely stony	A
CuB	Culleoka channery silt loam, 3 to 8 percent slopes	B
CuC	Culleoka channery silt loam, 8 to 15 percent slopes	B



CuD	Culleoka channery silt loam, 15 to 25 percent slopes	B
CwB	Culleoka-Weikert shaly silt loams, 3 to 8 percent slopes	B
CwC	Culleoka-Weikert shaly silt loams, 8 to 15 percent slopes	B
CwD	Culleoka-Weikert shaly silt loams, 15 to 25 percent slopes	B
DAM	Dam	D
DeB	Dekalb-Hazleton channery sandy loams, 0 to 8 percent slopes, extremely stony	A
DeD	Dekalb-Hazleton channery sandy loams, 8 to 25 percent slopes, extremely stony	A
DoB	Dormont silt loam, 3 to 8 percent slopes	D
DoC	Dormont silt loam, 8 to 15 percent slopes	D
DoD	Dormont silt loam, 15 to 25 percent slopes	D
DoE	Dormont silt loam, 25 to 35 percent slopes	D
DrD	Dormont-Culleoka complex, 15 to 25 percent slopes	D
DrE	Dormont-Culleoka complex, 25 to 50 percent slopes	D
Du	Dumps, coal wastes	D
ErB	Ernest silt loam, 3 to 8 percent slopes	C
ErC	Ernest silt loam, 8 to 15 percent slopes	C
ErD	Ernest silt loam, 15 to 25 percent slopes	C
EvB	Ernest-Vandergrift silt loams, 3 to 8 percent slopes	C
EvC	Ernest-Vandergrift silt loams, 8 to 15 percent slopes	C
EvD	Ernest-Vandergrift silt loams, 15 to 25 percent slopes	C
FaB	Fairpoint very channery silt loam, 0 to 8 percent slopes	C
FaC	Fairpoint very channery silt loam, 8 to 15 percent slopes	C
FaD	Fairpoint very channery silt loam, 15 to 25 percent slopes	C
FaF	Fairpoint very channery silt loam, 25 to 70 percent slopes	D
GcB	Gilpin channery silt loam, 3 to 8 percent slopes	C
GcC	Gilpin channery silt loam, 8 to 15 percent slopes	C
GcD	Gilpin channery silt loam, 15 to 25 percent slopes	C
GIB	Gilpin silt loam, 3 to 8 percent slopes	C
GIC	Gilpin silt loam, 8 to 15 percent slopes	C
GID	Gilpin silt loam, 15 to 25 percent slopes	C
GoF	Gilpin-Rock outcrop complex, 45 to 100 percent slopes	C
GpB	Gilpin-Upshur complex, 3 to 8 percent slopes	C
GpC	Gilpin-Upshur complex, 8 to 15 percent slopes	C
GpD	Gilpin-Upshur complex, 15 to 25 percent slopes	C
GQF	Gilpin-Upshur complex, very steep	C
GrE	Gilpin-Vandergrift silt loams, slumped, 15 to 35 percent slopes	C
GSF	Gilpin, Weikert, Culleoka channery silt loams and 25 to 80 percent slopes	C
GuB	Gilpin-Upshur complex, 3 to 8 percent slopes	C
GuB	Guernsey silt loam, 3 to 8 percent slopes	C
GuC	Gilpin-Upshur complex, 8 to 15 percent slopes	C

GuC	Guernsey silt loam, 8 to 15 percent slopes	C
GuD	Gilpin-Upshur complex, 15 to 25 percent slopes	C
GuD	Guernsey silt loam, 15 to 25 percent slopes	C
GuF	Gilpin-Upshur complex, 25 to 75 percent slopes	C
GvB	Guernsey-Vandergrift silt loams, 3 to 8 percent slopes	C
GvC	Guernsey-Vandergrift silt loams, 8 to 15 percent slopes	C
GvD	Guernsey-Vandergrift silt loams, 15 to 25 percent slopes	C
GwB	Gilpin-Weikert channery silt loams, 3 to 8 percent slopes	C
GwC	Gilpin-Weikert channery silt loams, 8 to 15 percent slopes	C
GwD	Gilpin-Weikert channery silt loams, 15 to 25 percent slopes	C
GwF	Gilpin-Weikert channery silt loams, 25 to 70 percent slopes	C
GxA	Ginat silt loam, 0 to 2 percent slopes	D
GyB	Guernsey silt loam, 3 to 8 percent slopes	C
GyC	Guernsey silt loam, 8 to 15 percent slopes	C
GyD	Guernsey silt loam, 15 to 25 percent slopes	C
HaB	Hazleton loam, 3 to 8 percent slopes	A
HaC	Hazleton loam, 8 to 15 percent slopes	A
HaD	Hazleton loam, 15 to 25 percent slopes	A
HcB	Hazleton-Clymer complex, 0 to 8 percent slopes, extremely stony	A
HcD	Hazleton-Clymer complex, 8 to 25 percent slopes, extremely stony	A
Ho	Holly silt loam, 0 to 2 percent slopes	B
HTE	Hazleton loam, steep	A
ItB	Itmann extremely channery loam, 0 to 8 percent slopes	A
ItD	Itmann extremely channery loam, 8 to 25 percent slopes	A
IxF	Itmann extremely channery loam, 25 to 70 percent slopes	A
LaB	Laidig gravelly loam, 0 to 8 percent slopes, extremely stony	C
LaD	Laidig gravelly loam, 8 to 25 percent slopes, extremely stony	C
LaE	Laidig gravelly loam, 25 to 35 percent slopes, extremely stony	C
LbB	Library silty clay loam, 3 to 8 percent slopes	C
LbC	Library silty clay loam, 8 to 15 percent slopes	C
LbD	Library silty clay loam, 15 to 25 percent slopes	C
LbF	Laidig-Hazleton complex, 35 to 80 percent slopes, extremely bouldery	C
Ld	Land fill	D
LeB	Leck Kill channery silt loam, 3 to 8 percent slopes	A
LeC	Leck Kill channery silt loam, 8 to 15 percent slopes	A
LkB	Leck Kill channery silt loam, 0 to 8 percent slopes, extremely stony	A
LkD	Leck Kill channery silt loam, 8 to 25 percent slopes, extremely stony	A
LIB	Library silt loam, 0 to 8 percent slopes	C
LIC	Library silt loam, 8 to 15 percent slopes	C
Ln	Lindside silt loam, 0 to 3 percent slopes, occasionally flooded	B
Lo	Lobdell silt loam, 0 to 3 percent slopes, occasionally flooded	B

LwB	Lowell silty clay loam, 3 to 8 percent slopes	C
LwC	Lowell silty clay loam, 8 to 15 percent slopes, eroded	C
LwD	Lowell silty clay loam, 15 to 25 percent slopes, eroded	C
LxF	Lowell-Culleoka complex, 25 to 80 percent slopes, very rocky	C
MaF	Macove-Gilpin channery silt loams, 35 to 70 percent slopes, extremely stony	A
MeB	Matewan channery loam, 3 to 8 percent slopes	A
MeC	Matewan channery loam, 8 to 15 percent slopes	A
MeD	Matewan channery loam, 15 to 25 percent slopes	A
MeF	Matewan channery loam, 25 to 50 percent slopes	A
MkD	Meckesville channery silt loam, 8 to 25 percent slopes, extremely stony	C
MkF	Meckesville channery silt loam, 25 to 70 percent slopes, extremely stony	C
Mn	Melvin and Newark silt loams, 0 to 2 percent slopes	B
MoA	Monongahela silt loam, 0 to 3 percent slopes	D
MoB	Monongahela silt loam, 3 to 8 percent slopes	D
MoC	Monongahela silt loam, 8 to 15 percent slopes	D
Ne	Newark silt loam, 0 to 3 percent slopes, frequently flooded	B
NoB	Nolo loam, 0 to 8 percent slopes, very stony	C
Pa	Palms muck, 0 to 3 percent slopes	B
Ph	Philo silt loam, 0 to 3 percent slopes, occasionally flooded	B
Ph	Philo loam, 0 to 3 percent slopes, occasionally flooded	B
Pu	Purdy silt loam, 0 to 2 percent slopes	C
Qu	Quarries	D
RaA	Rainsboro silt loam, 0 to 3 percent slopes	C
RgB	Rayne channery silt loam, 0 to 8 percent slopes, very stony	B
RgD	Rayne channery silt loam, 8 to 25 percent slopes, very stony	B
ScB	Sciotoville silt loam, 2 to 6 percent slopes	C
ScC	Sciotoville silt loam, 6 to 12 percent slopes	C
ShF	Shelocta-Gilpin channery silt loams, 25 to 75 percent slopes	B
SmB	Strip mines, 0 to 8 percent slopes	C
SmD	Strip mines, 8 to 25 percent slopes	C
SmF	Strip mines, 25 to 75 percent slopes	C
SxF	Shelocta-Gilpin channery silt loams, 25 to 75 percent slopes, very stony	B
ThA	Thorndale silt loam, 0 to 3 percent slopes	C
ThB	Thorndale silt loam, 3 to 8 percent slopes	C
TyA	Tyler silt loam, 0 to 2 percent slopes	D
UaB	Udorthents, 0 to 8 percent slopes	C
UaB	Upshur silty clay loam, 3 to 8 percent slopes	C
UaC	Upshur silty clay loam, 8 to 15 percent slopes	C
UaD	Udorthents, 8 to 25 percent slopes	C
UaF	Udorthents, 25 to 75 percent slopes	C
UbB	Urban Land, 0 to 8 percent slopes	C



UCB	Urban land-Culleoka complex, gently sloping	C
UcB	Upshur silty clay loam, 3 to 8 percent slopes	C
UcC	Upshur silty clay loam, 8 to 15 percent slopes	C
UCD	Urban land-Culleoka complex, moderately steep	C
UCE	Urban land-Culleoka complex, steep	C
UdA	Urban land, 0 to 3 percent slopes	C
UdB	Urban land, 3 to 8 percent slopes	C
UdC	Urban land, 8 to 15 percent slopes	C
UeB	Urban land-Culleoka complex, 0 to 8 percent slopes	C
UeD	Urban land-Culleoka complex, 8 to 25 percent slopes	C
UgB	Urban land-Gilpin complex, 0 to 8 percent slopes	C
UGB	Urban land-Guernsey complex, gently sloping	C
UgD	Urban land-Gilpin complex, 8 to 25 percent slopes	C
UGD	Urban land-Guernsey complex, moderately steep	C
UhB	Urban land-Guernsey complex, 0 to 8 percent slopes	C
UhD	Urban land-Guernsey complex, 8 to 25 percent slopes	C
UmB	Urban land-Monongahela complex, 0 to 8 percent slopes	C
URB	Urban land-Rainsboro complex, gently sloping	C
UuB	Urban land-Upshur complex, 0 to 8 percent slopes	C
UuD	Urban land-Upshur complex, 8 to 25 percent slopes	C
UwB	Urban land-Wharton complex, 0 to 8 percent slopes	C
UWB	Urban land-Wharton complex, gently sloping	C
UwD	Urban land-Wharton complex, 8 to 25 percent slopes	C
UWD	Urban land-Wharton complex, moderately steep	C
VaB	Vandergrift silt loam, 3 to 8 percent slopes	C
VaC	Vandergrift silt loam, 8 to 15 percent slopes	C
VaD	Vandergrift silt loam, 15 to 25 percent slopes	C
W	Water	D
WeA	Weinbach silt loam, 0 to 2 percent slopes	C
WhB	Wharton silt loam, 3 to 8 percent slopes	C
WhC	Wharton silt loam, 8 to 15 percent slopes	C
WhD	Wharton silt loam, 15 to 25 percent slopes	C
WrB	Wharton silt loam, 3 to 8 percent slopes	C
WrC	Wharton silt loam, 8 to 15 percent slopes	C
WrD	Wharton silt loam, 15 to 25 percent slopes	C
WsB	Wharton silt loam, 0 to 8 percent slopes, very stony	C
WsD	Wharton silt loam, 8 to 25 percent slopes, very stony	C

## Appendix: StreamStats data for each modeled Area of Interest

Data produced by the USGS online Web application StreamStats (Version 4.2.0) was used as a comparison to modeled hydrological results in each area of interest (Roland, M.A., and Stuckey, M.H. 2008). StreamStats provides access to Geographic Information Systems (GIS) analytical tools, spatial data, and modeling that can be used in water-resources planning applications, among others. This web application was used to delineate drainage areas for selected sites in the watershed, determine relevant basin characteristics, and estimate flow statistics. This approach allowed us to calibrate hydrological models in the absence of multiple stream gage locations in the watershed (Stuckey, M.H. 2006; Roland, M.A., and Stuckey, M.H. 2008). Stream Stats for individual Areas of Interest follow.

# StreamStats Report - Conemaugh Area of Interest

Region ID: PA  
 Workspace ID: PA20171129210006272000  
 Clicked Point (Latitude, Longitude): 40.39838, -79.26314  
 Time: 2017-11-29 16:00:30 -0500

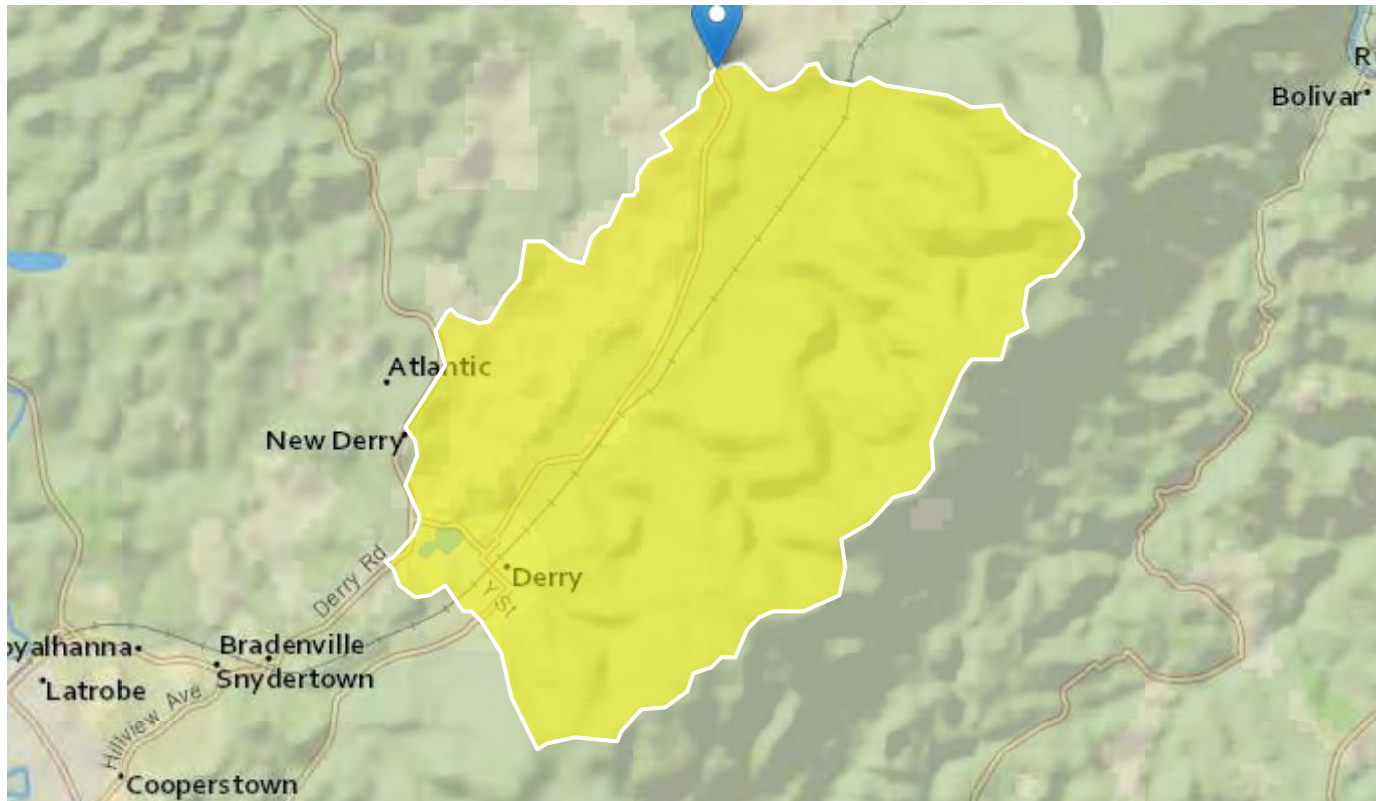

## Basin Characteristics

Parameter Code	Parameter Description	Value	Unit
BSLOPD	Mean basin slope measured in degrees	8.4	degrees
BSLOPDRAW	Unadjusted basin slope, in degrees	8.66	
CARBON	Percentage of area of carbonate rock	0	percent
CENTROXA83	X coordinate of the centroid, in NAD_1983_Albers, meters	-107203.2	
CENTROYA83	Basin centroid horizontal (y) location in NAD 1983 Albers	151452.5	
DRN	Drainage quality index from STATSGO	3.4	
DRNAREA	Area that drains to a point on a stream	22.3	square miles
ELEV	Mean Basin Elevation	1556.1	feet
FOREST	Percentage of area covered by forest	76	percent
GLACIATED	Percentage of basin area that was historically covered by glaciers	0	percent
IMPNLCD01	Percentage of impervious area determined from NLCD 2001 impervious dataset	3	percent



Parameter Code	Parameter Description	Value	Unit
LC01DEV	Percentage of land-use from NLCD 2001 classes 21-24	11	percent
LC11DEV	Percentage of developed (urban) land from NLCD 2011 classes 21-24	10.9	percent
LC11IMP	Average percentage of impervious area determined from NLCD 2011 impervious dataset	2.93	percent
LONG_OUT	Longitude of Basin Outlet	-79.26319	degrees
MAXTEMP	Mean annual maximum air temperature over basin area from PRISM 1971-2000 800-m grid	58	degrees F
OUTLETXA83	X coordinate of the outlet, in NAD_1983_Albers,meters	-107225	
OUTLETYA83	Y coordinate of the outlet, in NAD_1983_Albers, meters	156015	
PRECIP	Mean Annual Precipitation	44	inches
ROCKDEP	Depth to rock	4.5	feet
STORAGE	Percentage of area of storage (lakes ponds reservoirs wetlands)	0	percent
STRDEN	Stream Density -- total length of streams divided by drainage area	2.11	miles per square mile
STRMTOT	total length of all mapped streams (1:24,000-scale) in the basin	47.24	miles
URBAN	Percentage of basin with urban development	6	percent

#### Low-Flow Statistics Parameters [Low Flow Region 3]

Parameter Code	Parameter Name	Value	Units	Min Limit	Max Limit
DRNAREA	Drainage Area	22.3	square miles	2.33	1720
ELEV	Mean Basin Elevation	1556.1	feet	898	2700
PRECIP	Mean Annual Precipitation	44	inches	38.7	47.9

#### Low-Flow Statistics Flow Report [Low Flow Region 3]

PII: Prediction Interval-Lower, PIu: Prediction Interval-Upper, SEp: Standard Error of Prediction, SE: Standard Error (other -- see report)

Statistic	Value	Unit	SE	SEp
7 Day 2 Year Low Flow	2.52	ft <sup>3</sup> /s	43	43
30 Day 2 Year Low Flow	3.57	ft <sup>3</sup> /s	38	38
7 Day 10 Year Low Flow	1.2	ft <sup>3</sup> /s	54	54
30 Day 10 Year Low Flow	1.63	ft <sup>3</sup> /s	49	49
90 Day 10 Year Low Flow	2.36	ft <sup>3</sup> /s	41	41

#### Low-Flow Statistics Citations

Stuckey, M.H.,2006, Low-flow, base-flow, and mean-flow regression equations for Pennsylvania streams: U.S. Geological Survey Scientific Investigations Report 2006-5130, 84 p. (<http://pubs.usgs.gov/sir/2006/5130/>)

#### Peak-Flow Statistics Parameters [Peak Flow Region 4]

Parameter Code	Parameter Name	Value	Units	Min Limit	Max Limit
DRNAREA	Drainage Area	22.3	square miles	0.92	1720

**Peak-Flow Statistics Flow Report** [Peak Flow Region 4]

PIl: Prediction Interval-Lower, PIu: Prediction Interval-Upper, SEp: Standard Error of Prediction, SE: Standard Error (other -- see report)

Statistic	Value	Unit	SE	SEp	Equiv. Yrs.
2 Year Peak Flood	917	ft <sup>3</sup> /s	28	28	4
5 Year Peak Flood	1550	ft <sup>3</sup> /s	26	26	7
10 Year Peak Flood	2060	ft <sup>3</sup> /s	28	28	10
50 Year Peak Flood	3460	ft <sup>3</sup> /s	33	33	13
100 Year Peak Flood	4190	ft <sup>3</sup> /s	38	38	13
500 Year Peak Flood	6260	ft <sup>3</sup> /s	49	49	12

*Peak-Flow Statistics Citations*

**Roland, M.A., and Stuckey, M.H.,2008, Regression equations for estimating flood flows at selected recurrence intervals for ungaged streams in Pennsylvania: U.S. Geological Survey Scientific Investigations Report 2008-5102, 57p. (<http://pubs.usgs.gov/sir/2008/5102/>)**

**Annual Flow Statistics Parameters** [Statewide Mean and Base Flow]

Parameter Code	Parameter Name	Value	Units	Min Limit	Max Limit
DRNAREA	Drainage Area	22.3	square miles	2.26	1720
ELEV	Mean Basin Elevation	1556.1	feet	130	2700
PRECIP	Mean Annual Precipitation	44	inches	33.1	50.4
FOREST	Percent Forest	76	percent	5.1	100
URBAN	Percent Urban	6	percent	0	89

**Annual Flow Statistics Flow Report** [Statewide Mean and Base Flow]

PIl: Prediction Interval-Lower, PIu: Prediction Interval-Upper, SEp: Standard Error of Prediction, SE: Standard Error (other -- see report)

Statistic	Value	Unit	SE	SEp
Mean Annual Flow	39.3	ft <sup>3</sup> /s	12	12

*Annual Flow Statistics Citations*

**Stuckey, M.H.,2006, Low-flow, base-flow, and mean-flow regression equations for Pennsylvania streams: U.S. Geological Survey Scientific Investigations Report 2006-5130, 84 p. (<http://pubs.usgs.gov/sir/2006/5130/>)**

**General Flow Statistics Parameters** [Statewide Mean and Base Flow]

Parameter Code	Parameter Name	Value	Units	Min Limit	Max Limit
DRNAREA	Drainage Area	22.3	square miles	2.26	1720

Parameter Code	Parameter Name	Value	Units	Min Limit	Max Limit
PRECIP	Mean Annual Precipitation	44	inches	33.1	50.4
CARBON	Percent Carbonate	0	percent	0	99
FOREST	Percent Forest	76	percent	5.1	100
URBAN	Percent Urban	6	percent	0	89

### General Flow Statistics Flow Report [Statewide Mean and Base Flow]

PIl: Prediction Interval-Lower, PIu: Prediction Interval-Upper, SEp: Standard Error of Prediction, SE: Standard Error (other -- see report)

Statistic	Value	Unit	SE	SEp
Harmonic Mean Streamflow	9.61	ft <sup>3</sup> /s	38	38

### General Flow Statistics Citations

Stuckey, M.H.,2006, Low-flow, base-flow, and mean-flow regression equations for Pennsylvania streams: U.S. Geological Survey Scientific Investigations Report 2006-5130, 84 p. (<http://pubs.usgs.gov/sir/2006/5130/>)

### Base Flow Statistics Parameters [Statewide Mean and Base Flow]

Parameter Code	Parameter Name	Value	Units	Min Limit	Max Limit
DRNAREA	Drainage Area	22.3	square miles	2.26	1720
PRECIP	Mean Annual Precipitation	44	inches	33.1	50.4
CARBON	Percent Carbonate	0	percent	0	99
FOREST	Percent Forest	76	percent	5.1	100
URBAN	Percent Urban	6	percent	0	89

### Base Flow Statistics Flow Report [Statewide Mean and Base Flow]

PIl: Prediction Interval-Lower, PIu: Prediction Interval-Upper, SEp: Standard Error of Prediction, SE: Standard Error (other -- see report)

Statistic	Value	Unit	SE	SEp
Base Flow 10 Year Recurrence Interval	15.3	ft <sup>3</sup> /s	21	21
Base Flow 25 Year Recurrence Interval	13.6	ft <sup>3</sup> /s	21	21
Base Flow 50 Year Recurrence Interval	12.7	ft <sup>3</sup> /s	23	23

### Base Flow Statistics Citations

Stuckey, M.H.,2006, Low-flow, base-flow, and mean-flow regression equations for Pennsylvania streams: U.S. Geological Survey Scientific Investigations Report 2006-5130, 84 p. (<http://pubs.usgs.gov/sir/2006/5130/>)



# StreamStats Report Kiski AOI

Region ID: PA  
 Workspace ID: PA20171004152955343000  
 Clicked Point (Latitude, Longitude): 40.44474, -79.54797  
 Time: 2017-10-04 11:30:18 -0400

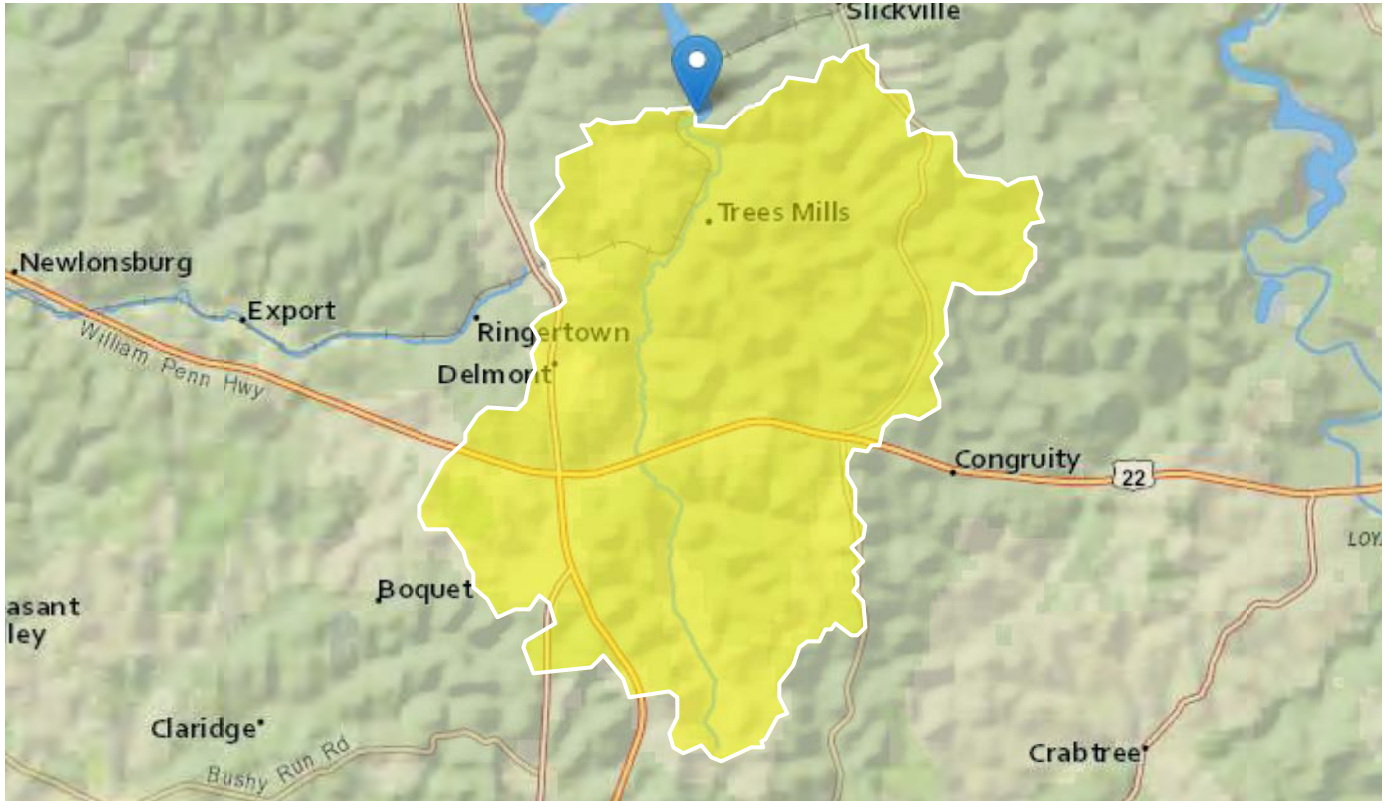

## Basin Characteristics

Parameter Code	Parameter Description	Value	Unit
DRNAREA	Area that drains to a point on a stream	19.6	square miles
ELEV	Mean Basin Elevation	1254.3	feet
PRECIP	Mean Annual Precipitation	41	inches
FOREST	Percentage of area covered by forest	49	percent
URBAN	Percentage of basin with urban development	6	percent
CARBON	Percentage of area of carbonate rock	0	percent

## Low-Flow Statistics Parameters [100 Percent (19.6 square miles) Low Flow Region 3]

Parameter Code	Parameter Name	Value	Units	Min Limit	Max Limit
DRNAREA	Drainage Area	19.6	square miles	2.33	1720

Parameter Code	Parameter Name	Value	Units	Min Limit	Max Limit
ELEV	Mean Basin Elevation	1254.3	feet	898	2700
PRECIP	Mean Annual Precipitation	41	inches	38.7	47.9

### Low-Flow Statistics Flow Report [100 Percent (19.6 square miles) Low Flow Region 3]

PIl: Prediction Interval-Lower, PIu: Prediction Interval-Upper, SEp: Standard Error of Prediction, SE: Standard Error (other -- see report)

Statistic	Value	Unit	SE	SEp
7 Day 2 Year Low Flow	1.59	ft <sup>3</sup> /s	43	43
30 Day 2 Year Low Flow	2.25	ft <sup>3</sup> /s	38	38
7 Day 10 Year Low Flow	0.669	ft <sup>3</sup> /s	54	54
30 Day 10 Year Low Flow	0.969	ft <sup>3</sup> /s	49	49
90 Day 10 Year Low Flow	1.44	ft <sup>3</sup> /s	41	41

### Low-Flow Statistics Citations

Stuckey, M.H., 2006, Low-flow, base-flow, and mean-flow regression equations for Pennsylvania streams: U.S. Geological Survey Scientific Investigations Report 2006-5130, 84 p. (<http://pubs.usgs.gov/sir/2006/5130/>)

### Peak-Flow Statistics Parameters [Peak Flow Region 4]

Parameter Code	Parameter Name	Value	Units	Min Limit	Max Limit
DRNAREA	Drainage Area	19.6	square miles	0.92	1720

### Peak-Flow Statistics Flow Report [Peak Flow Region 4]

PIl: Prediction Interval-Lower, PIu: Prediction Interval-Upper, SEp: Standard Error of Prediction, SE: Standard Error (other -- see report)

Statistic	Value	Unit	SE	SEp	Equiv. Yrs.
2 Year Peak Flood	822	ft <sup>3</sup> /s	28	28	4
5 Year Peak Flood	1390	ft <sup>3</sup> /s	26	26	7
10 Year Peak Flood	1860	ft <sup>3</sup> /s	28	28	10
50 Year Peak Flood	3140	ft <sup>3</sup> /s	33	33	13
100 Year Peak Flood	3800	ft <sup>3</sup> /s	38	38	13
500 Year Peak Flood	5690	ft <sup>3</sup> /s	49	49	12

### Peak-Flow Statistics Citations

Roland, M.A., and Stuckey, M.H., 2008, Regression equations for estimating flood flows at selected recurrence intervals for ungaged streams in Pennsylvania: U.S. Geological Survey Scientific Investigations Report 2008-5102, 57p. (<http://pubs.usgs.gov/sir/2008/5102/>)

### Annual Flow Statistics Parameters [Statewide Mean and Base Flow]

Parameter Code	Parameter Name	Value	Units	Min Limit	Max Limit
----------------	----------------	-------	-------	-----------	-----------

Parameter Code	Parameter Name	Value	Units	Min Limit	Max Limit
DRNAREA	Drainage Area	19.6	square miles	2.26	1720
ELEV	Mean Basin Elevation	1254.3	feet	130	2700
PRECIP	Mean Annual Precipitation	41	inches	33.1	50.4
FOREST	Percent Forest	49	percent	5.1	100
URBAN	Percent Urban	6	percent	0	89

### Annual Flow Statistics Flow Report [Statewide Mean and Base Flow]

PII: Prediction Interval-Lower, PIu: Prediction Interval-Upper, SEp: Standard Error of Prediction, SE: Standard Error (other -- see report)

Statistic	Value	Unit	SE	SEp
Mean Annual Flow	27.6	ft <sup>3</sup> /s	12	12

### Annual Flow Statistics Citations

Stuckey, M.H.,2006, Low-flow, base-flow, and mean-flow regression equations for Pennsylvania streams: U.S. Geological Survey Scientific Investigations Report 2006-5130, 84 p. (<http://pubs.usgs.gov/sir/2006/5130/>)

### General Flow Statistics Parameters [Statewide Mean and Base Flow]

Parameter Code	Parameter Name	Value	Units	Min Limit	Max Limit
DRNAREA	Drainage Area	19.6	square miles	2.26	1720
PRECIP	Mean Annual Precipitation	41	inches	33.1	50.4
CARBON	Percent Carbonate	0	percent	0	99
FOREST	Percent Forest	49	percent	5.1	100
URBAN	Percent Urban	6	percent	0	89

### General Flow Statistics Flow Report [Statewide Mean and Base Flow]

PII: Prediction Interval-Lower, PIu: Prediction Interval-Upper, SEp: Standard Error of Prediction, SE: Standard Error (other -- see report)

Statistic	Value	Unit	SE	SEp
Harmonic Mean Streamflow	5.48	ft <sup>3</sup> /s	38	38

### General Flow Statistics Citations

Stuckey, M.H.,2006, Low-flow, base-flow, and mean-flow regression equations for Pennsylvania streams: U.S. Geological Survey Scientific Investigations Report 2006-5130, 84 p. (<http://pubs.usgs.gov/sir/2006/5130/>)

### Base Flow Statistics Parameters [Statewide Mean and Base Flow]

Parameter Code	Parameter Name	Value	Units	Min Limit	Max Limit
DRNAREA	Drainage Area	19.6	square miles	2.26	1720
PRECIP	Mean Annual Precipitation	41	inches	33.1	50.4
CARBON	Percent Carbonate	0	percent	0	99



Parameter Code	Parameter Name	Value	Units	Min Limit	Max Limit
FOREST	Percent Forest	49	percent	5.1	100
URBAN	Percent Urban	6	percent	0	89

### Base Flow Statistics Flow Report [Statewide Mean and Base Flow]

PIl: Prediction Interval-Lower, PIu: Prediction Interval-Upper, SEp: Standard Error of Prediction, SE: Standard Error (other -- see report)

Statistic	Value	Unit	SE	SEp
Base Flow 10 Year Recurrence Interval	8.97	ft <sup>3</sup> /s	21	21
Base Flow 25 Year Recurrence Interval	7.84	ft <sup>3</sup> /s	21	21
Base Flow 50 Year Recurrence Interval	7.21	ft <sup>3</sup> /s	23	23

### *Base Flow Statistics Citations*

**Stuckey, M.H.,2006, Low-flow, base-flow, and mean-flow regression equations for Pennsylvania streams: U.S. Geological Survey Scientific Investigations Report 2006-5130, 84 p. (<http://pubs.usgs.gov/sir/2006/5130/>)**

# StreamStats Report for Monongahela Area of Interest

Region ID: PA  
 Workspace ID: PA20171229164929621000  
 Clicked Point (Latitude, Longitude): 40.12844, -79.87726  
 Time: 2017-12-29 11:49:50 -0500

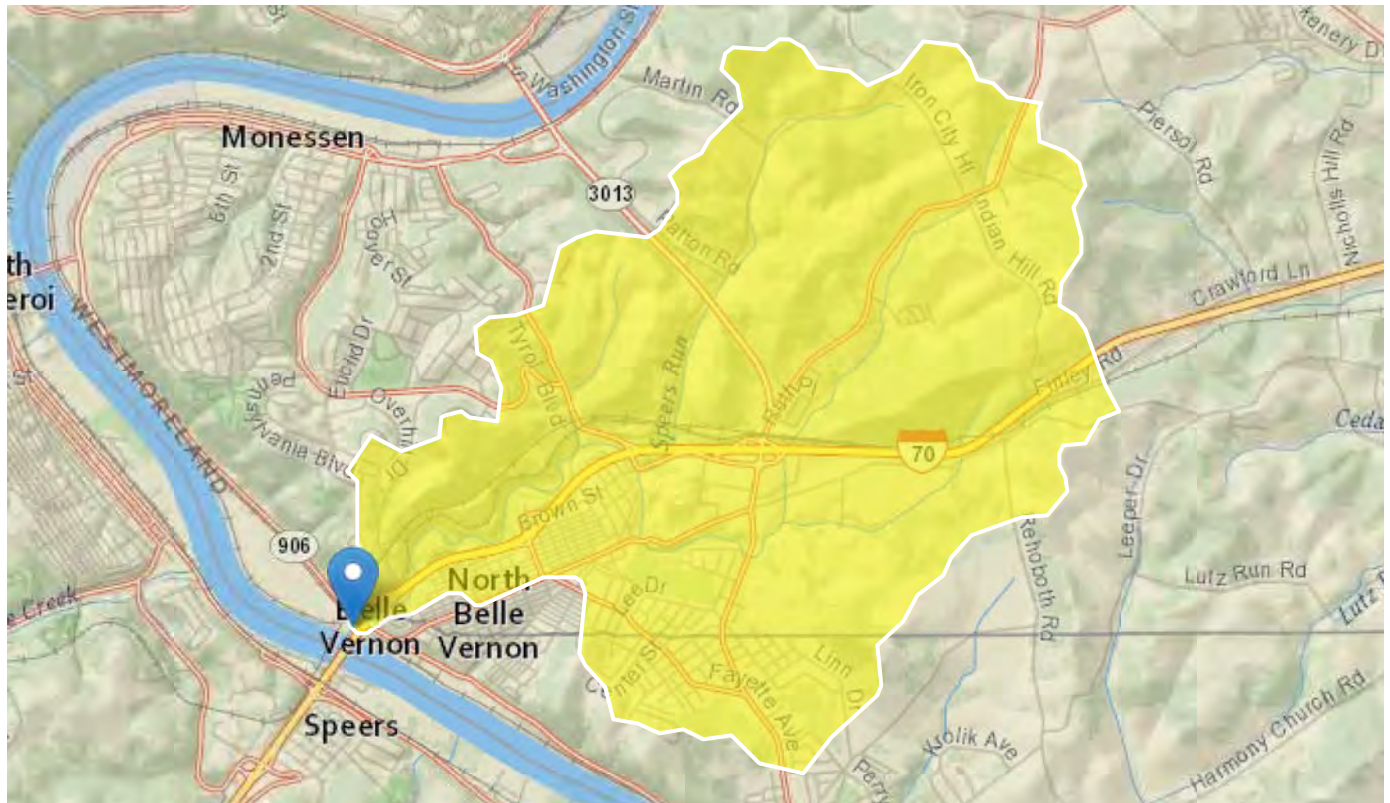

## Basin Characteristics

Parameter Code	Parameter Description	Value	Unit
DRNAREA	Area that drains to a point on a stream	6.65	square miles
ELEV	Mean Basin Elevation	1030.9	feet
PRECIP	Mean Annual Precipitation	37	inches
FOREST	Percentage of area covered by forest	49	percent
URBAN	Percentage of basin with urban development	22	percent
CARBON	Percentage of area of carbonate rock	0	percent
BSLOPD	Mean basin slope measured in degrees	7.7	degrees
BSLOPDRAW	Unadjusted basin slope, in degrees	7.94	
CENTROXA83	X coordinate of the centroid, in NAD_1983_Albers, meters	-156906.8	
CENTROYA83	Basin centroid horizontal (y) location in NAD 1983 Albers	128557.1	
DRN	Drainage quality index from STATSGO	3.7	

Parameter Code	Parameter Description	Value	Unit
GLACIATED	Percentage of basin area that was historically covered by glaciers	0	percent
IMPNLCD01	Percentage of impervious area determined from NLCD 2001 impervious dataset	15	percent
LC01DEV	Percentage of land-use from NLCD 2001 classes 21-24	36	percent
LC11DEV	Percentage of developed (urban) land from NLCD 2011 classes 21-24	38	percent
LC11IMP	Average percentage of impervious area determined from NLCD 2011 impervious dataset	16.1	percent
LONG_OUT	Longitude of Basin Outlet	-79.87723	degrees
MAXTEMP	Mean annual maximum air temperature over basin area from PRISM 1971-2000 800-m grid	61	degrees F
OUTLETXA83	X coordinate of the outlet, in NAD_1983_Albers,meters	-159985	
OUTLETYA83	Y coordinate of the outlet, in NAD_1983_Albers, meters	126985	
ROCKDEP	Depth to rock	4.4	feet
STORAGE	Percentage of area of storage (lakes ponds reservoirs wetlands)	0	percent
STRDEN	Stream Density -- total length of streams divided by drainage area	2.14	miles per square mile
STRMTOT	total length of all mapped streams (1:24,000-scale) in the basin	14.2	miles

#### Peak-Flow Statistics Parameters [Peak Flow Region 4]

Parameter Code	Parameter Name	Value	Units	Min Limit	Max Limit
DRNAREA	Drainage Area	6.65	square miles	0.92	1720

#### Peak-Flow Statistics Flow Report [Peak Flow Region 4]

PIl: Prediction Interval-Lower, PIu: Prediction Interval-Upper, SEp: Standard Error of Prediction, SE: Standard Error (other -- see report)

Statistic	Value	Unit	SE	SEp	Equiv. Yrs.
2 Year Peak Flood	330	ft <sup>3</sup> /s	28	28	4
5 Year Peak Flood	577	ft <sup>3</sup> /s	26	26	7
10 Year Peak Flood	784	ft <sup>3</sup> /s	28	28	10
50 Year Peak Flood	1360	ft <sup>3</sup> /s	33	33	13
100 Year Peak Flood	1670	ft <sup>3</sup> /s	38	38	13
500 Year Peak Flood	2530	ft <sup>3</sup> /s	49	49	12

#### Peak-Flow Statistics Citations

**Roland, M.A., and Stuckey, M.H.,2008, Regression equations for estimating flood flows at selected recurrence intervals for ungaged streams in Pennsylvania: U.S. Geological Survey Scientific Investigations Report 2008-5102, 57p. (<http://pubs.usgs.gov/sir/2008/5102/>)**

#### Low-Flow Statistics Parameters [Low Flow Region 4]



Parameter Code	Parameter Name	Value	Units	Min Limit	Max Limit
DRNAREA	Drainage Area	6.65	square miles	2.26	1400
ELEV	Mean Basin Elevation	1030.9	feet	1050	2580

#### Low-Flow Statistics Disclaimers [Low Flow Region 4]

One or more of the parameters is outside the suggested range. Estimates were extrapolated with unknown errors

#### Low-Flow Statistics Flow Report [Low Flow Region 4]

Statistic	Value	Unit
7 Day 2 Year Low Flow	0.214	ft <sup>3</sup> /s
30 Day 2 Year Low Flow	0.375	ft <sup>3</sup> /s
7 Day 10 Year Low Flow	0.078	ft <sup>3</sup> /s
30 Day 10 Year Low Flow	0.143	ft <sup>3</sup> /s
90 Day 10 Year Low Flow	0.258	ft <sup>3</sup> /s

#### Low-Flow Statistics Citations

Stuckey, M.H., 2006, Low-flow, base-flow, and mean-flow regression equations for Pennsylvania streams: U.S. Geological Survey Scientific Investigations Report 2006-5130, 84 p. (<http://pubs.usgs.gov/sir/2006/5130/>)

#### Annual Flow Statistics Parameters [Statewide Mean and Base Flow]

Parameter Code	Parameter Name	Value	Units	Min Limit	Max Limit
DRNAREA	Drainage Area	6.65	square miles	2.26	1720
ELEV	Mean Basin Elevation	1030.9	feet	130	2700
PRECIP	Mean Annual Precipitation	37	inches	33.1	50.4
FOREST	Percent Forest	49	percent	5.1	100
URBAN	Percent Urban	22	percent	0	89

#### Annual Flow Statistics Flow Report [Statewide Mean and Base Flow]

PIl: Prediction Interval-Lower, PIu: Prediction Interval-Upper, SEp: Standard Error of Prediction, SE: Standard Error (other -- see report)

Statistic	Value	Unit	SE	SEp
Mean Annual Flow	7.97	ft <sup>3</sup> /s	12	12

#### Annual Flow Statistics Citations

Stuckey, M.H., 2006, Low-flow, base-flow, and mean-flow regression equations for Pennsylvania streams: U.S. Geological Survey Scientific Investigations Report 2006-5130, 84 p. (<http://pubs.usgs.gov/sir/2006/5130/>)

### General Flow Statistics Parameters [Statewide Mean and Base Flow]

Parameter Code	Parameter Name	Value	Units	Min Limit	Max Limit
DRNAREA	Drainage Area	6.65	square miles	2.26	1720
PRECIP	Mean Annual Precipitation	37	inches	33.1	50.4
CARBON	Percent Carbonate	0	percent	0	99
FOREST	Percent Forest	49	percent	5.1	100
URBAN	Percent Urban	22	percent	0	89

### General Flow Statistics Flow Report [Statewide Mean and Base Flow]

PII: Prediction Interval-Lower, PIu: Prediction Interval-Upper, SEp: Standard Error of Prediction, SE: Standard Error (other -- see report)

Statistic	Value	Unit	SE	SEp
Harmonic Mean Streamflow	1.36	ft <sup>3</sup> /s	38	38

#### *General Flow Statistics Citations*

Stuckey, M.H.,2006, Low-flow, base-flow, and mean-flow regression equations for Pennsylvania streams: U.S. Geological Survey Scientific Investigations Report 2006-5130, 84 p. (<http://pubs.usgs.gov/sir/2006/5130/>)

### Base Flow Statistics Parameters [Statewide Mean and Base Flow]

Parameter Code	Parameter Name	Value	Units	Min Limit	Max Limit
DRNAREA	Drainage Area	6.65	square miles	2.26	1720
PRECIP	Mean Annual Precipitation	37	inches	33.1	50.4
CARBON	Percent Carbonate	0	percent	0	99
FOREST	Percent Forest	49	percent	5.1	100
URBAN	Percent Urban	22	percent	0	89

### Base Flow Statistics Flow Report [Statewide Mean and Base Flow]

PII: Prediction Interval-Lower, PIu: Prediction Interval-Upper, SEp: Standard Error of Prediction, SE: Standard Error (other -- see report)

Statistic	Value	Unit	SE	SEp
Base Flow 10 Year Recurrence Interval	2.53	ft <sup>3</sup> /s	21	21
Base Flow 25 Year Recurrence Interval	2.21	ft <sup>3</sup> /s	21	21
Base Flow 50 Year Recurrence Interval	2.04	ft <sup>3</sup> /s	23	23

#### *Base Flow Statistics Citations*

Stuckey, M.H.,2006, Low-flow, base-flow, and mean-flow regression equations for Pennsylvania streams: U.S. Geological Survey Scientific Investigations Report 2006-5130, 84 p. (<http://pubs.usgs.gov/sir/2006/5130/>)

# StreamStats Report Sewickley Creek

Region ID: PA  
 Workspace ID: PA20171229170515324000  
 Clicked Point (Latitude, Longitude): 40.23032, -79.77787  
 Time: 2017-12-29 12:05:35 -0500



## Basin Characteristics

Parameter Code	Parameter Description	Value	Unit
DRNAREA	Area that drains to a point on a stream	168	square miles
ELEV	Mean Basin Elevation	1130.1	feet
PRECIP	Mean Annual Precipitation	41	inches
FOREST	Percentage of area covered by forest	43	percent
URBAN	Percentage of basin with urban development	14	percent
CARBON	Percentage of area of carbonate rock	0	percent
BSLOPD	Mean basin slope measured in degrees	6.7	degrees
BSLOPDRAW	Unadjusted basin slope, in degrees	6.96	
CENTROXA83	X coordinate of the centroid, in NAD_1983_Albers, meters	-135358.4	
CENTROYA83	Basin centroid horizontal (y) location in NAD 1983 Albers	139162.8	
DRN	Drainage quality index from STATSGO	3.6	



Parameter Code	Parameter Description	Value	Unit
GLACIATED	Percentage of basin area that was historically covered by glaciers	0	percent
IMPNLCD01	Percentage of impervious area determined from NLCD 2001 impervious dataset	6	percent
LC01DEV	Percentage of land-use from NLCD 2001 classes 21-24	20	percent
LC11DEV	Percentage of developed (urban) land from NLCD 2011 classes 21-24	23.2	percent
LC11IMP	Average percentage of impervious area determined from NLCD 2011 impervious dataset	7.36	percent
LONG_OUT	Longitude of Basin Outlet	-79.77783	degrees
MAXTEMP	Mean annual maximum air temperature over basin area from PRISM 1971-2000 800-m grid	60	degrees F
OUTLETXA83	X coordinate of the outlet, in NAD_1983_Albers,meters	-151285	
OUTLETYA83	Y coordinate of the outlet, in NAD_1983_Albers, meters	138115	
ROCKDEP	Depth to rock	4.4	feet
STORAGE	Percentage of area of storage (lakes ponds reservoirs wetlands)	0	percent
STRDEN	Stream Density -- total length of streams divided by drainage area	1.99	miles per square mile
STRMTOT	total length of all mapped streams (1:24,000-scale) in the basin	334.09	miles

#### Peak-Flow Statistics Parameters [Peak Flow Region 4]

Parameter Code	Parameter Name	Value	Units	Min Limit	Max Limit
DRNAREA	Drainage Area	168	square miles	0.92	1720

#### Peak-Flow Statistics Flow Report [Peak Flow Region 4]

PIl: Prediction Interval-Lower, PIu: Prediction Interval-Upper, SEp: Standard Error of Prediction, SE: Standard Error (other -- see report)

Statistic	Value	Unit	SE	SEp	Equiv. Yrs.
2 Year Peak Flood	5050	ft <sup>3</sup> /s	28	28	4
5 Year Peak Flood	7990	ft <sup>3</sup> /s	26	26	7
10 Year Peak Flood	10300	ft <sup>3</sup> /s	28	28	10
50 Year Peak Flood	16400	ft <sup>3</sup> /s	33	33	13
100 Year Peak Flood	19600	ft <sup>3</sup> /s	38	38	13
500 Year Peak Flood	28400	ft <sup>3</sup> /s	49	49	12

#### Peak-Flow Statistics Citations

**Roland, M.A., and Stuckey, M.H.,2008, Regression equations for estimating flood flows at selected recurrence intervals for ungaged streams in Pennsylvania: U.S. Geological Survey Scientific Investigations Report 2008-5102, 57p. (<http://pubs.usgs.gov/sir/2008/5102/>)**

#### Low-Flow Statistics Parameters [100 Percent (168 square miles) Low Flow Region 4]

Parameter Code	Parameter Name	Value	Units	Min Limit	Max Limit
DRNAREA	Drainage Area	168	square miles	2.26	1400
ELEV	Mean Basin Elevation	1130.1	feet	1050	2580

### Low-Flow Statistics Flow Report [100 Percent (168 square miles) Low Flow Region 4]

PIl: Prediction Interval-Lower, PIu: Prediction Interval-Upper, SEp: Standard Error of Prediction, SE: Standard Error (other -- see report)

Statistic	Value	Unit	SE	SEp
7 Day 2 Year Low Flow	9.16	ft <sup>3</sup> /s	43	43
30 Day 2 Year Low Flow	13.9	ft <sup>3</sup> /s	38	38
7 Day 10 Year Low Flow	4.41	ft <sup>3</sup> /s	66	66
30 Day 10 Year Low Flow	6.39	ft <sup>3</sup> /s	54	54
90 Day 10 Year Low Flow	10	ft <sup>3</sup> /s	41	41

### Low-Flow Statistics Citations

Stuckey, M.H., 2006, Low-flow, base-flow, and mean-flow regression equations for Pennsylvania streams: U.S. Geological Survey Scientific Investigations Report 2006-5130, 84 p. (<http://pubs.usgs.gov/sir/2006/5130/>)

### Annual Flow Statistics Parameters [Statewide Mean and Base Flow]

Parameter Code	Parameter Name	Value	Units	Min Limit	Max Limit
DRNAREA	Drainage Area	168	square miles	2.26	1720
ELEV	Mean Basin Elevation	1130.1	feet	130	2700
PRECIP	Mean Annual Precipitation	41	inches	33.1	50.4
FOREST	Percent Forest	43	percent	5.1	100
URBAN	Percent Urban	14	percent	0	89

### Annual Flow Statistics Flow Report [Statewide Mean and Base Flow]

PIl: Prediction Interval-Lower, PIu: Prediction Interval-Upper, SEp: Standard Error of Prediction, SE: Standard Error (other -- see report)

Statistic	Value	Unit	SE	SEp
Mean Annual Flow	240	ft <sup>3</sup> /s	12	12

### Annual Flow Statistics Citations

Stuckey, M.H., 2006, Low-flow, base-flow, and mean-flow regression equations for Pennsylvania streams: U.S. Geological Survey Scientific Investigations Report 2006-5130, 84 p. (<http://pubs.usgs.gov/sir/2006/5130/>)

### General Flow Statistics Parameters [Statewide Mean and Base Flow]

Parameter Code	Parameter Name	Value	Units	Min Limit	Max Limit
DRNAREA	Drainage Area	168	square miles	2.26	1720
PRECIP	Mean Annual Precipitation	41	inches	33.1	50.4

Parameter Code	Parameter Name	Value	Units	Min Limit	Max Limit
CARBON	Percent Carbonate	0	percent	0	99
FOREST	Percent Forest	43	percent	5.1	100
URBAN	Percent Urban	14	percent	0	89

### General Flow Statistics Flow Report [Statewide Mean and Base Flow]

PII: Prediction Interval-Lower, PIu: Prediction Interval-Upper, SEp: Standard Error of Prediction, SE: Standard Error (other -- see report)

Statistic	Value	Unit	SE	SEp
Harmonic Mean Streamflow	57.3	ft <sup>3</sup> /s	38	38

### General Flow Statistics Citations

Stuckey, M.H.,2006, Low-flow, base-flow, and mean-flow regression equations for Pennsylvania streams: U.S. Geological Survey Scientific Investigations Report 2006-5130, 84 p. (<http://pubs.usgs.gov/sir/2006/5130/>)

### Base Flow Statistics Parameters [Statewide Mean and Base Flow]

Parameter Code	Parameter Name	Value	Units	Min Limit	Max Limit
DRNAREA	Drainage Area	168	square miles	2.26	1720
PRECIP	Mean Annual Precipitation	41	inches	33.1	50.4
CARBON	Percent Carbonate	0	percent	0	99
FOREST	Percent Forest	43	percent	5.1	100
URBAN	Percent Urban	14	percent	0	89

### Base Flow Statistics Flow Report [Statewide Mean and Base Flow]

PII: Prediction Interval-Lower, PIu: Prediction Interval-Upper, SEp: Standard Error of Prediction, SE: Standard Error (other -- see report)

Statistic	Value	Unit	SE	SEp
Base Flow 10 Year Recurrence Interval	75.3	ft <sup>3</sup> /s	21	21
Base Flow 25 Year Recurrence Interval	66.1	ft <sup>3</sup> /s	21	21
Base Flow 50 Year Recurrence Interval	60.8	ft <sup>3</sup> /s	23	23

### Base Flow Statistics Citations

Stuckey, M.H.,2006, Low-flow, base-flow, and mean-flow regression equations for Pennsylvania streams: U.S. Geological Survey Scientific Investigations Report 2006-5130, 84 p. (<http://pubs.usgs.gov/sir/2006/5130/>)



# StreamStats Report Turtle Creek Basin to Wilmerding

Region ID: PA  
 Workspace ID: PA20171229165653079000  
 Clicked Point (Latitude, Longitude): 40.39433, -79.80570  
 Time: 2017-12-29 11:57:13 -0500

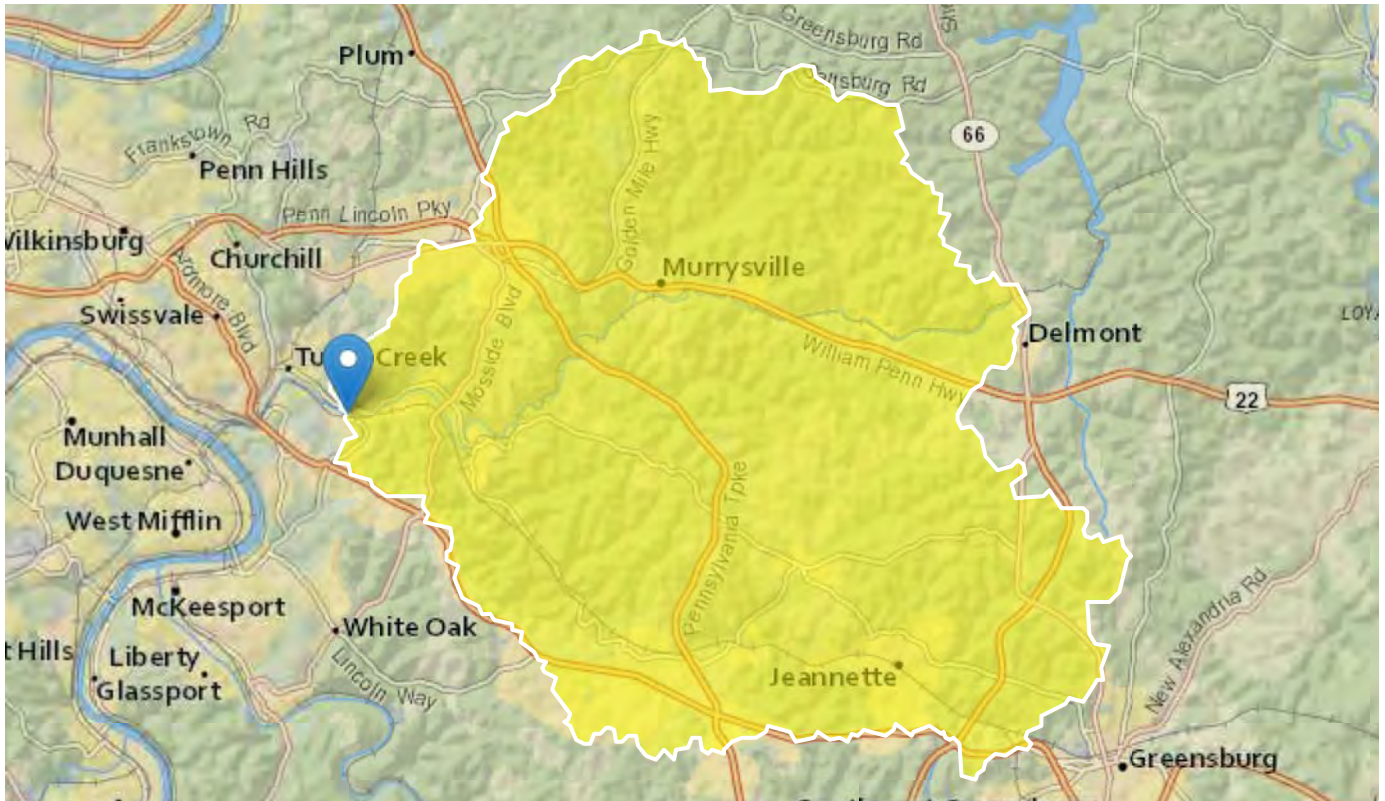

## Basin Characteristics

Parameter Code	Parameter Description	Value	Unit
DRNAREA	Area that drains to a point on a stream	123	square miles
ELEV	Mean Basin Elevation	1123.7	feet
PRECIP	Mean Annual Precipitation	39	inches
FOREST	Percentage of area covered by forest	52	percent
URBAN	Percentage of basin with urban development	26	percent
CARBON	Percentage of area of carbonate rock	0	percent
BSLOPD	Mean basin slope measured in degrees	8.1	degrees
BSLOPDRAW	Unadjusted basin slope, in degrees	8.27	
CENTROXA83	X coordinate of the centroid, in NAD_1983_Albers, meters	-142120.2	
CENTROYA83	Basin centroid horizontal (y) location in NAD 1983 Albers	155799.4	
DRN	Drainage quality index from STATSGO	3.5	

Parameter Code	Parameter Description	Value	Unit
GLACIATED	Percentage of basin area that was historically covered by glaciers	0	percent
IMPNLCD01	Percentage of impervious area determined from NLCD 2001 impervious dataset	12	percent
LC01DEV	Percentage of land-use from NLCD 2001 classes 21-24	35	percent
LC11DEV	Percentage of developed (urban) land from NLCD 2011 classes 21-24	39.5	percent
LC11IMP	Average percentage of impervious area determined from NLCD 2011 impervious dataset	13.7	percent
LONG_OUT	Longitude of Basin Outlet	-79.80565	degrees
MAXTEMP	Mean annual maximum air temperature over basin area from PRISM 1971-2000 800-m grid	60	degrees F
OUTLETXA83	X coordinate of the outlet, in NAD_1983_Albers,meters	-153275	
OUTLETYA83	Y coordinate of the outlet, in NAD_1983_Albers, meters	156375	
ROCKDEP	Depth to rock	4	feet
STORAGE	Percentage of area of storage (lakes ponds reservoirs wetlands)	0	percent
STRDEN	Stream Density -- total length of streams divided by drainage area	2.1	miles per square mile
STRMTOT	total length of all mapped streams (1:24,000-scale) in the basin	257.39	miles

#### Peak-Flow Statistics Parameters [Peak Flow Region 4]

Parameter Code	Parameter Name	Value	Units	Min Limit	Max Limit
DRNAREA	Drainage Area	123	square miles	0.92	1720

#### Peak-Flow Statistics Flow Report [Peak Flow Region 4]

PIl: Prediction Interval-Lower, PIu: Prediction Interval-Upper, SEp: Standard Error of Prediction, SE: Standard Error (other -- see report)

Statistic	Value	Unit	SE	SEp	Equiv. Yrs.
2 Year Peak Flood	3880	ft <sup>3</sup> /s	28	28	4
5 Year Peak Flood	6200	ft <sup>3</sup> /s	26	26	7
10 Year Peak Flood	8020	ft <sup>3</sup> /s	28	28	10
50 Year Peak Flood	12900	ft <sup>3</sup> /s	33	33	13
100 Year Peak Flood	15400	ft <sup>3</sup> /s	38	38	13
500 Year Peak Flood	22500	ft <sup>3</sup> /s	49	49	12

#### Peak-Flow Statistics Citations

**Roland, M.A., and Stuckey, M.H.,2008, Regression equations for estimating flood flows at selected recurrence intervals for ungaged streams in Pennsylvania: U.S. Geological Survey Scientific Investigations Report 2008-5102, 57p. (<http://pubs.usgs.gov/sir/2008/5102/>)**

#### Low-Flow Statistics Parameters [100 Percent (123 square miles) Low Flow Region 4]

Parameter Code	Parameter Name	Value	Units	Min Limit	Max Limit
DRNAREA	Drainage Area	123	square miles	2.26	1400
ELEV	Mean Basin Elevation	1123.7	feet	1050	2580

### Low-Flow Statistics Flow Report [100 Percent (123 square miles) Low Flow Region 4]

PIl: Prediction Interval-Lower, PIu: Prediction Interval-Upper, SEp: Standard Error of Prediction, SE: Standard Error (other -- see report)

Statistic	Value	Unit	SE	SEp
7 Day 2 Year Low Flow	6.39	ft <sup>3</sup> /s	43	43
30 Day 2 Year Low Flow	9.81	ft <sup>3</sup> /s	38	38
7 Day 10 Year Low Flow	2.99	ft <sup>3</sup> /s	66	66
30 Day 10 Year Low Flow	4.44	ft <sup>3</sup> /s	54	54
90 Day 10 Year Low Flow	7.07	ft <sup>3</sup> /s	41	41

### Low-Flow Statistics Citations

Stuckey, M.H.,2006, Low-flow, base-flow, and mean-flow regression equations for Pennsylvania streams: U.S. Geological Survey Scientific Investigations Report 2006-5130, 84 p. (<http://pubs.usgs.gov/sir/2006/5130/>)

### Annual Flow Statistics Parameters [Statewide Mean and Base Flow]

Parameter Code	Parameter Name	Value	Units	Min Limit	Max Limit
DRNAREA	Drainage Area	123	square miles	2.26	1720
ELEV	Mean Basin Elevation	1123.7	feet	130	2700
PRECIP	Mean Annual Precipitation	39	inches	33.1	50.4
FOREST	Percent Forest	52	percent	5.1	100
URBAN	Percent Urban	26	percent	0	89

### Annual Flow Statistics Flow Report [Statewide Mean and Base Flow]

PIl: Prediction Interval-Lower, PIu: Prediction Interval-Upper, SEp: Standard Error of Prediction, SE: Standard Error (other -- see report)

Statistic	Value	Unit	SE	SEp
Mean Annual Flow	171	ft <sup>3</sup> /s	12	12

### Annual Flow Statistics Citations

Stuckey, M.H.,2006, Low-flow, base-flow, and mean-flow regression equations for Pennsylvania streams: U.S. Geological Survey Scientific Investigations Report 2006-5130, 84 p. (<http://pubs.usgs.gov/sir/2006/5130/>)

### General Flow Statistics Parameters [Statewide Mean and Base Flow]

Parameter Code	Parameter Name	Value	Units	Min Limit	Max Limit
DRNAREA	Drainage Area	123	square miles	2.26	1720
PRECIP	Mean Annual Precipitation	39	inches	33.1	50.4



Parameter Code	Parameter Name	Value	Units	Min Limit	Max Limit
CARBON	Percent Carbonate	0	percent	0	99
FOREST	Percent Forest	52	percent	5.1	100
URBAN	Percent Urban	26	percent	0	89

### General Flow Statistics Flow Report [Statewide Mean and Base Flow]

PII: Prediction Interval-Lower, PIu: Prediction Interval-Upper, SEp: Standard Error of Prediction, SE: Standard Error (other -- see report)

Statistic	Value	Unit	SE	SEp
Harmonic Mean Streamflow	40	ft <sup>3</sup> /s	38	38

### General Flow Statistics Citations

Stuckey, M.H.,2006, Low-flow, base-flow, and mean-flow regression equations for Pennsylvania streams: U.S. Geological Survey Scientific Investigations Report 2006-5130, 84 p. (<http://pubs.usgs.gov/sir/2006/5130/>)

### Base Flow Statistics Parameters [Statewide Mean and Base Flow]

Parameter Code	Parameter Name	Value	Units	Min Limit	Max Limit
DRNAREA	Drainage Area	123	square miles	2.26	1720
PRECIP	Mean Annual Precipitation	39	inches	33.1	50.4
CARBON	Percent Carbonate	0	percent	0	99
FOREST	Percent Forest	52	percent	5.1	100
URBAN	Percent Urban	26	percent	0	89

### Base Flow Statistics Flow Report [Statewide Mean and Base Flow]

PII: Prediction Interval-Lower, PIu: Prediction Interval-Upper, SEp: Standard Error of Prediction, SE: Standard Error (other -- see report)

Statistic	Value	Unit	SE	SEp
Base Flow 10 Year Recurrence Interval	55.6	ft <sup>3</sup> /s	21	21
Base Flow 25 Year Recurrence Interval	49.3	ft <sup>3</sup> /s	21	21
Base Flow 50 Year Recurrence Interval	45.6	ft <sup>3</sup> /s	23	23

### Base Flow Statistics Citations

Stuckey, M.H.,2006, Low-flow, base-flow, and mean-flow regression equations for Pennsylvania streams: U.S. Geological Survey Scientific Investigations Report 2006-5130, 84 p. (<http://pubs.usgs.gov/sir/2006/5130/>)